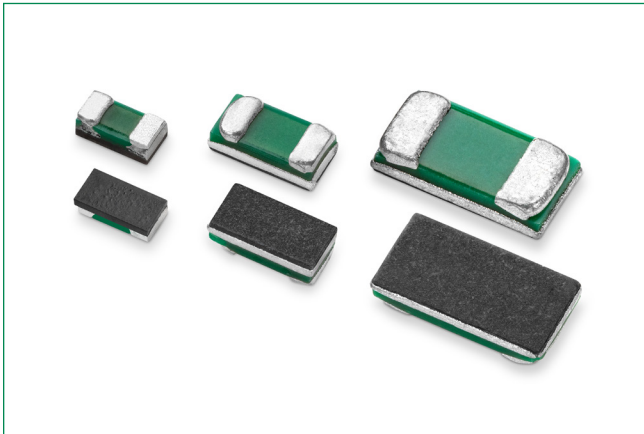

# Surface Mount High Current Jumper

## AEC-Q200 Qualified > WJC-A Series

**HF** **RoHS** **Pb**

### Description

Littelfuse WJC-A Series is a high-current metal foil jumper chip.

### Features

- Maximum resistance of 1 mΩ
- Maximum current of 40 A
- Glass epoxy substrate
- AEC-Q200 Qualified

### Benefits

- Small size
- High voltage

### Application

- Power management
- Low ESL
- Server
- Automotive

### Additional Information



Resources



Accessories



Samples

### Electrical Specifications

Part Number	Size		Resistance Value Max (mΩ)	I <sub>max</sub> (A)	Standard Package Qty
	Inch	mm			
WJC0201LJUMPFKR-A	0201	0603	1	8	10000
WJC0402LJUMPFKR-A	0402	1005	0.5	20	10000
WJC0603LJUMPFNR-A	0603	1608	0.2	26	5000
WJC0805LJUMPFNR-A	0805	2012	0.2	35	5000
WJC1206LJUMPFNR-A	1206	3216	0.2	40	5000

# Surface Mount High Current Jumper

AEC-Q200 Qualified > WJC-A Series

## Temperature De-rating Curve

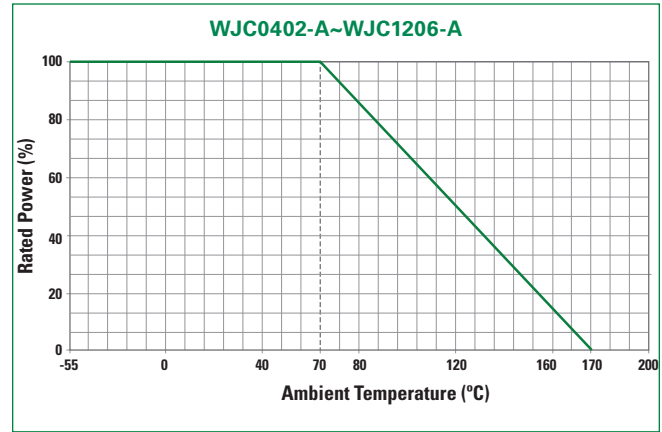
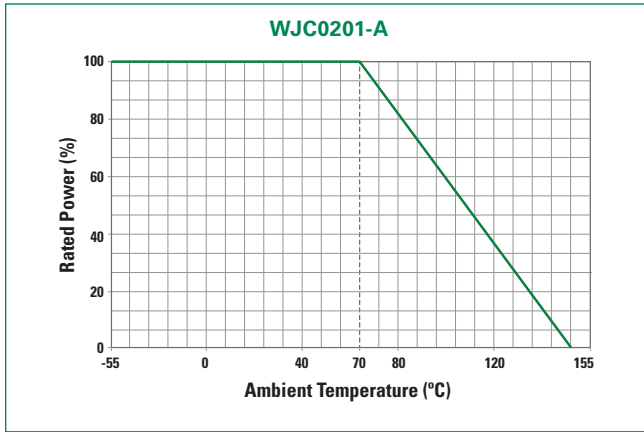

## Storage / Environment Conditions

Products should be stored under the following environmental conditions.

<b>Temperature:</b>	+5 to +35 °C
<b>Humidity:</b>	45 to 85% relative humidity

Do not keep products in environments where they may be subject to particulate contamination or harmful gases such as sulfuric acid or hydrogen chloride as it may cause oxidization on electrodes, resulting poor solderability.

Products should be stored in a space that does not expose to high temperatures, vibration, or direct sunlight.

Products should be stored in the original airtight packaging until use.

## Soldering Parameters—Wave Soldering

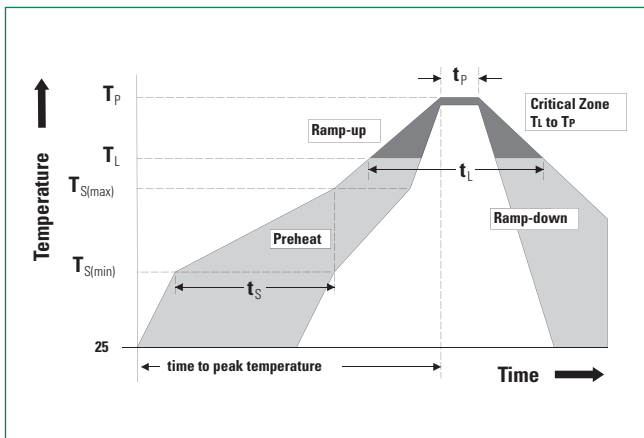

Profile Feature	Pb-Free Assembly
<b>Average Ramp-Up Rate (TS<sub>max</sub> to TP)</b>	3 °C / second max
<b>Preheat</b>	
Temperature Minimum (TS <sub>min</sub> )	150 °C
Temperature Maximum (TS <sub>max</sub> )	200 °C
Time (TS <sub>min</sub> to TS <sub>max</sub> )	60–180 seconds
<b>Time maintained above</b>	
Temperature Minimum (TL)	217 °C
Time (tL)	60–150 seconds
<b>Peak Temperature (TP)</b>	260 +0 °C
<b>Time within 5 °C of Actual Peak Temperature (tp)</b>	20–40 seconds
<b>Ramp-Down Rate</b>	6 °C / second Maximum
<b>Time 25 °C to Peak Temperature</b>	8 minutes Maximum

# Surface Mount High Current Jumper

## AEC-Q200 Qualified > WJC-A Series

### AEC-Q200 Reliability Specifications

Test	Procedure	Specifications
<b>High Temp. Exposure (Storage)</b> MIL-STD-202, Method 108	Test Temp 170 °C Test Period: 1,000 hours No Electrical Load	±1.0%
<b>Temp. Cycling (Thermal Shock)</b> JESD22 Method JA-104	Repeat 1,000 cycles as follows: -55 +/-3 °C for 30 minutes 155 +/-3 °C for 30 minutes Transition time of 1 minute max	±1.0%
<b>Biased Humidity</b> MIL-STD-202, Method 103	Test conditions: 85 °C and 85% RH 10% of rated power Test Period 1,000 hours	±1.0%
<b>Load Life (Operational Life)</b> MIL-STD-202, Method 108	Test Temperature: 125 +/- 3 °C Applied voltage: rated power (derated Power will be required if temp exceeds the derating point of part) Test Period: 1,000 hours (condition D)	±1.0%
<b>Resistance to Solvents</b> MIL-STD-202, Method 215	3 minute soak, 2–3 ounce force, 10 strokes / repetition, 3 repetitions	No damage
<b>Mechanical Shock</b> MIL-STD-202, Method 213	Force: 100 G peak. Test duration: 6 ms, Half-sine waveform, Velocity: 12.3 ft / sec	±1.0%
<b>Vibration</b> MIL-STD-202, Method 204	Frequency: 10–2,000 Hz Acceleration: 5G Test duration: 20 minutes, 12 cycles	±1.0%
<b>Resistance to Soldering Heat</b> MIL-STD-202, Method 210	Condition B (Solder dip, no pre-heat) 260 °C	±1.0%
<b>ESD</b> AEC-Q200-002	HBM, 100 pF, 1.5 kΩ. Repetition: 5 times	±1.0%
<b>Solderability J-STD-002</b>	Non-activated flux dip: 5-10 seconds. SAC solder dip: 2 ± 0.5 seconds at 245 °C	95% coverage
<b>Flammability UL-94</b>	V-0 or V-1 are acceptable. Electrical test not required	Provide certificate
<b>Board Flex AEC-Q200-005</b>	90 mm span between fulcrums, 2 mm bend. 60 seconds minimum holding time	±1.0%
<b>Terminal Strength (SMD)</b> AEC-Q200-006	Force of 17.7 N 60 seconds	±1.0%
<b>Flame Retardance</b> AEC-Q200-001	Mounted parts subjected to voltages from 9.0 to 32 VDC (current clamped up to 500 A) in 1.0 VDC increments. Voltage applied for 1 hour minimum or until failure occurs	Must meet AEC-Q200 requirements

# Surface Mount High Current Jumper

## AEC-Q200 Qualified > WJC-A Series

### Dimensions

All dimensions in mm

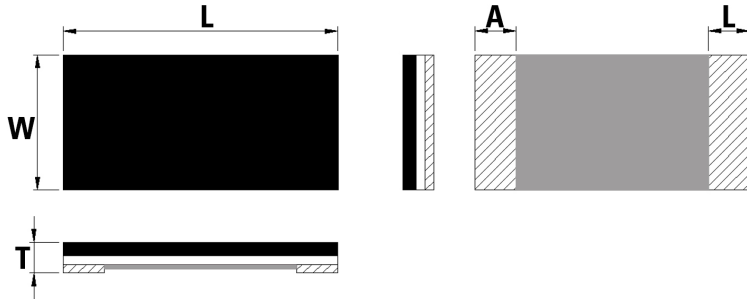

Part Number	W	L	T	A
WJC0201-A	0.30±0.04	0.60±0.03	0.25±0.10	0.15±0.06
WJC0402-A	0.50±0.20	1.00±0.20	0.30±0.15	0.20±0.15
WJC0603-A	0.80±0.20	1.60±0.20	0.35±0.20	0.35±0.20
WJC0805-A	1.25±0.20	2.00±0.20	0.40±0.20	0.35±0.20
WJC1206-A	1.60±0.20	3.20±0.20	0.40±0.20	0.50±0.20

### Recommended Land Pattern

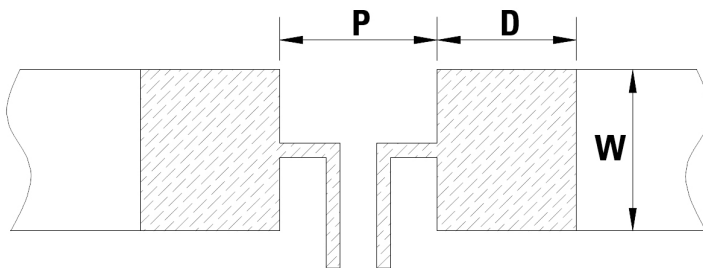

Part Number	P	W	D	Loading
WJC0201-A	0.25 mm	0.33 mm	0.20 mm	8 A
WJC0402-A	0.40 mm	0.60 mm	0.60 mm	20 A
WJC0603-A	0.60 mm	0.92 mm	1.30 mm	26 A
WJC0805-A	0.80 mm	1.44 mm	1.40 mm	35 A
WJC1206-A	1.20 mm	1.84 mm	1.80 mm	40 A

### Packaging

Part Number	Halogen Free	Packaging Option	Quantity	Quantity & Packaging Codes
WJC0201-A	Yes	Tape and Reel	10000	KR
WJC0402-A	Yes	Tape and Reel	10000	KR
WJC0603-A	Yes	Tape and Reel	5000	NR
WJC0805-A	Yes	Tape and Reel	5000	NR
WJC1206-A	Yes	Tape and Reel	5000	NR

# Surface Mount High Current Jumper

## AEC-Q200 Qualified > WJC-A Series

### Part Numbering System

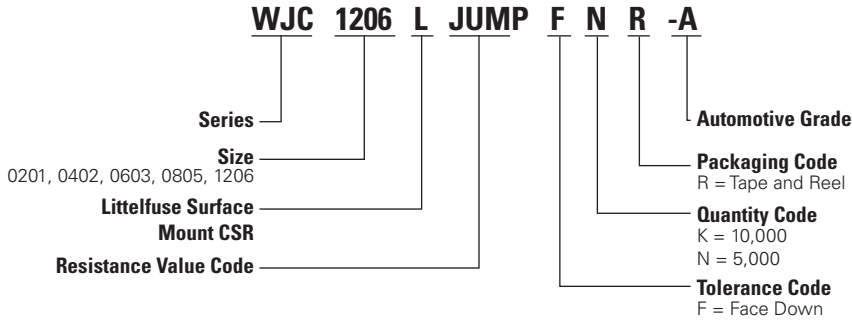

### Tape and Reel Specifications

All dimensions in mm

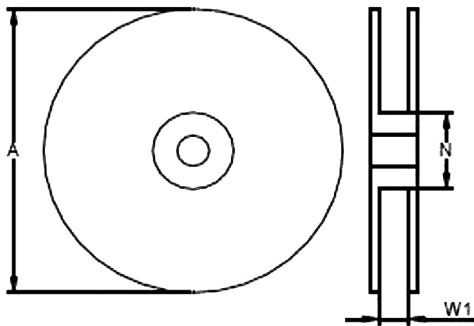

Part Number	A±5 (mm)	N±2 (mm)	W1±1 (mm)
WJC-A	178	60	9.0

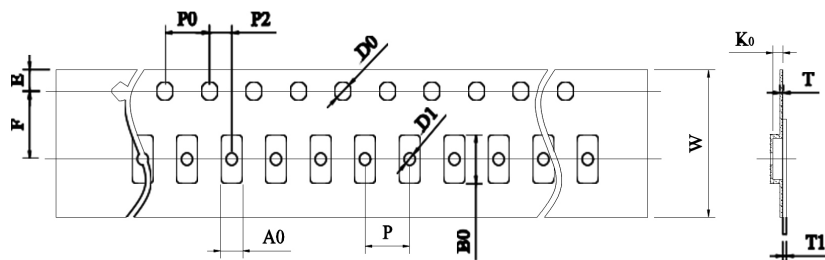

Part Number	W	P0	P	P2	A0	B0	D0	F	E	T	T1	K0
WJC0201-A	8.00±0.20	4.00±0.10	2.00±0.10	2.00±0.10	0.38±0.10	0.68±0.10	1.50±0.10	3.50±0.10	1.75±0.10	0.45±0.05	Max. 0.1	0.30±0.05
WJC0402-A	8.00±0.30	4.00±0.10	2.00±0.10	2.00±0.10	0.65±0.10	1.10±0.10	1.50±0.10	3.50±0.10	1.75±0.10	0.42±0.05	/	/
WJC0603-A	8.00±0.30	4.00±0.10	4.00±0.10	2.00±0.10	0.98±0.10	1.85±0.10	1.50±0.10	3.50±0.10	1.75±0.10	0.60±0.05	/	/
WJC0805-A	8.00±0.30	4.00±0.10	4.00±0.10	2.00±0.10	1.55±0.10	2.30±0.10	1.50±0.10	3.50±0.10	1.75±0.10	0.60±0.10	/	/
WJC1206-A	8.00±0.30	4.00±0.10	4.00±0.10	2.00±0.10	2.05±0.20	3.65±0.20	1.50±0.10	3.50±0.10	1.75±0.10	0.60±0.10	/	/

**Note:** Tape and reel packaging according to EIA-481

**Disclaimer Notice** - Information furnished is believed to be accurate and reliable. However, users should independently evaluate the suitability of and test each product selected for their own applications. Littelfuse products are not designed for, and may not be used in, all applications. Read complete Disclaimer Notice at <http://www.littelfuse.com/disclaimer-electronics>.