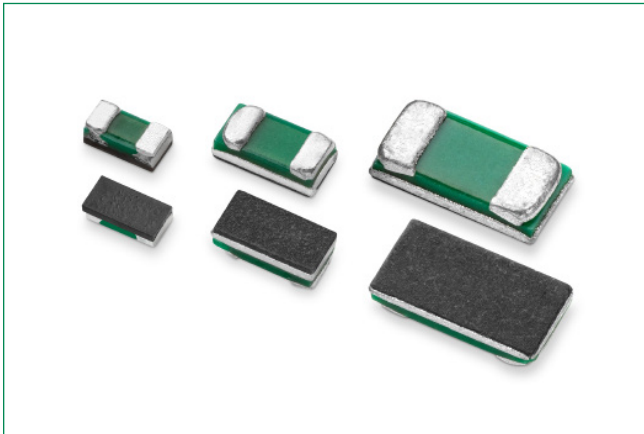

Surface Mount High Current Jumper

WJC Series

HF **RoHS** **Pb**

Description

Littelfuse WJC Series is a high-current metal foil jumper chip.

Features & Benefits

- Maximum resistance of 1 mΩ
- Maximum current of 40 A
- Epoxy substrate
- Small size
- High voltage

Application

- Power management
- Low ESL
- Server

Additional Information



Resources



Accessories



Samples

Electrical Specifications

Part Number	Size		Resistance Value Max (mΩ)	I _{max} (A)	Standard Package Quantity
	Inch	mm			
WJC0201LJUMPFKR	0201	603	1	8	10000
WJC0402LJUMPFKR	0402	1005	0.5	20	10000
WJC0603LJUMPFNR	0603	1608	0.2	26	5000
WJC0805LJUMPFNR	0805	2012	0.2	35	5000
WJC1206LJUMPFNR	1206	3216	0.2	40	5000

Surface Mount High Current Jumper

WJC Series

Temperature De-rating Curve

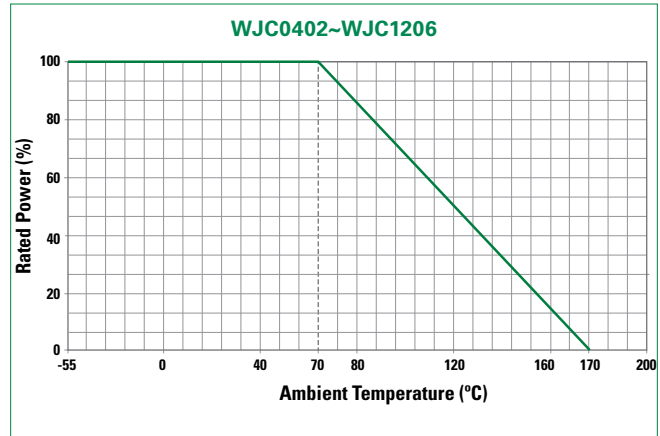
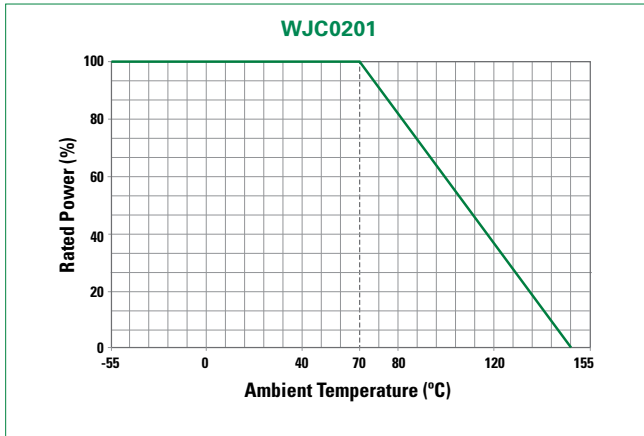

Storage / Environment Conditions

Products should be stored under the following environmental conditions.

Temperature:	+5 to +35 °C
Humidity:	45 to 85% relative humidity
Moisture Sensitivity Level:	1, J-STD-020

Do not keep products in environments where they may be subject to particulate contamination or harmful gases such as sulfuric acid or hydrogen chloride as it may cause oxidization on electrodes, resulting poor solderability.

Products should be stored in a space that does not expose to high temperatures, vibration, or direct sunlight.

Products should be stored in the original airtight packaging until use.

Soldering Parameters–Wave Soldering

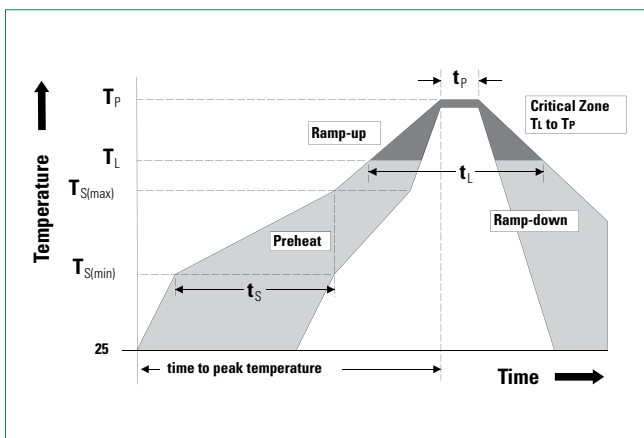

Profile Feature	Pb-Free Assembly
Average Ramp-Up Rate (TS_{max} to TP)	3 °C / second max
Preheat	
Temperature Minimum (TS _{min})	150 °C
Temperature Maximum (TS _{max})	200 °C
Time (TS _{min} to TS _{max})	60–180 seconds
Time maintained above	
Temperature Minimum (TL)	217 °C
Time (t _L)	60–150 seconds
Peak Temperature (TP)	260 +0 °C
Time within 5 °C of Actual Peak Temperature (tp)	20–40 seconds
Ramp-Down Rate	6 °C / second Maximum
Time 25 °C to Peak Temperature	8 minutes Maximum

Surface Mount High Current Jumper

WJC Series

Reliability Specifications

Test	Procedure	Specifications
ESD	HBM, 100pF, 1.5k ohms Repetition: 5 times Component Classification: 5C (25KV)	±1.0% Appearance: Without distinct damage, and the marking shall be legible.
Load Life (Operational Life)	Test Temperature: 125°C Applied voltage: rated power (derated Power will be required if temp exceeds the derating point of part) Test Period: 1,000 hours (condition D)	±1.0% Appearance: Without distinct damage, and the marking shall be legible.
Biased Humidity	Test conditions: 85°C and 85% RH 10% of rated power Test Period 1,000 hours	±1.0% Appearance: Without distinct damage, and the marking shall be legible.
Temp. Cycling (Thermal Shock)	Repeat 1,000 cycles as follows: -55°C for 30 minutes 125°C for 30 minutes Transition time of 1 minute max	±1.0% Appearance: Without distinct damage, and the marking shall be legible.
High Temp. Exposure (Storage)	Test Temp 125°C Test Period: 1,000 hours No Electrical Load	±1.0% Appearance: Without distinct damage, and the marking shall be legible.
Resistance to soldering heat	Condition B (Solder dip, no pre-heat) 260°C	±1.0% Parts must meet initial electrical specs.
Resistance to Solvents	3 minute soak 2-3 ounce force 10 strokes/repetition 3 repetitions	Appearance: Without distinct damage, and the marking shall be legible.
Terminal Strength (SMD)	Applied force based on part size	±1.0% Appearance: Without distinct damage, and the marking shall be legible.
Flammability	UL-94 V-0 or V-1 are acceptable Electrical test not required	V-0 burning less than 10 seconds or V-1 burning less than 30 seconds
Flame Retardance	Mounted parts subjected to voltages from 9.0 to 32 VDC (current clamped up to 500A)	No Flame when full automotive battery potential is applied.
Vibration	Frequency: 10-2,000Hz Acceleration: 5G Test duration: 20 minutes, 12 cycles	±1.0% Appearance: Without distinct damage, and the marking shall be legible.
Mechanical Shock	Force: 100G peak Test duration: 6 ms Half-sine waveform Velocity: 12.3ft/sec	±1.0% Appearance: Without distinct damage, and the marking shall be legible.
Board Flex	90 mm span between fulcrums 2 mm bend 60 seconds minimum holding time	±1.0% Appearance: Without distinct damage, and the marking shall be legible.
Solderability	Non-activated flux dip: 5-10 seconds SAC solder dip: 5 seconds at 245°C	A new solder shall cover minimum of 95%.

Surface Mount High Current Jumper

WJC Series

Dimensions

All dimensions in mm

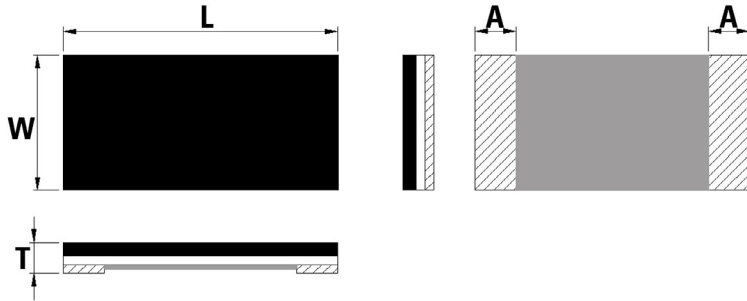

Part Number	W	L	T	A
WJC0201	0.30±0.04	0.60±0.03	0.25±0.10	0.15±0.06
WJC0402	0.50±0.20	1.00±0.20	0.30±0.15	0.20±0.15
WJC0603	0.80±0.20	1.60±0.20	0.35±0.20	0.35±0.20
WJC0805	1.25±0.20	2.00±0.20	0.40±0.20	0.35±0.20
WJC1206	1.60±0.20	3.20±0.20	0.40±0.20	0.50±0.20

Recommended Land Pattern

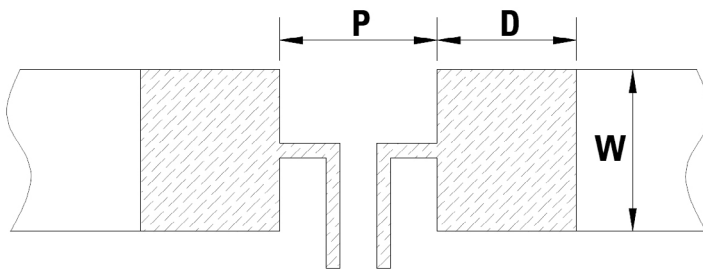

Part Number	P	W	D	Loading
WJC0201	0.25 mm	0.33 mm	0.20 mm	0.064 W
WJC0402	0.40 mm	0.60 mm	0.60 mm	0.2 W
WJC0603	0.60 mm	0.92 mm	1.30 mm	0.135 W
WJC0805	0.80 mm	1.44 mm	1.40 mm	0.245 W
WJC1206	1.20 mm	1.84 mm	1.80 mm	0.32 W

Packaging

Part Number	Halogen Free	Packaging Option	Quantity	Quantity & Packaging Codes
WJC0201	Yes	Tape and Reel	10000	KR
WJC0402	Yes	Tape and Reel	10000	KR
WJC0603	Yes	Tape and Reel	5000	NR
WJC0805	Yes	Tape and Reel	5000	NR
WJC1206	Yes	Tape and Reel	5000	NR

Surface Mount High Current Jumper

WJC Series

Part Numbering System

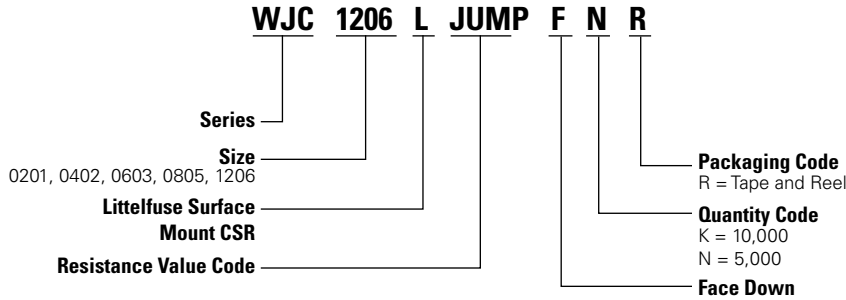

Tape and Reel Specifications

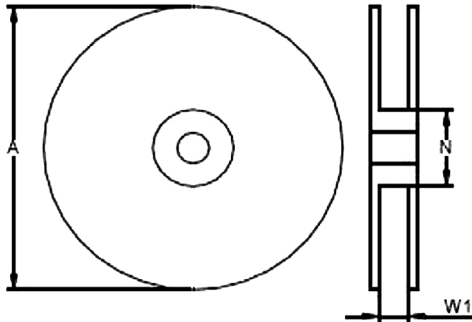

Part Number	A±5 (mm)	N±2 (mm)	W1±1 (mm)
WJC	178	60	9.0

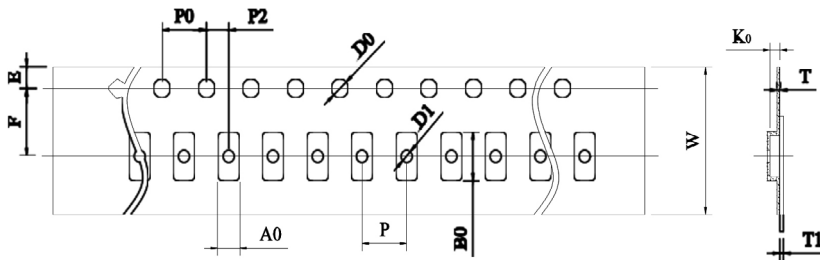

Part Number	W	P0	P	P2	A0	B0	D0	F	E	T	T1	K0
WJC0201	8.00±0.20	4.00±0.10	2.00±0.10	2.00±0.10	0.38±0.10	0.68±0.10	1.50±0.10	3.50±0.10	1.75±0.10	0.45±0.05	Max. 0.1	0.30±0.05
WJC0402	8.00±0.30	4.00±0.10	2.00±0.10	2.00±0.10	0.65±0.10	1.10±0.10	1.50±0.10	3.50±0.10	1.75±0.10	0.42±0.05	/	/
WJC0603	8.00±0.30	4.00±0.10	4.00±0.10	2.00±0.10	0.98±0.10	1.85±0.10	1.50±0.10	3.50±0.10	1.75±0.10	0.60±0.05	/	/
WJC0805	8.00±0.30	4.00±0.10	4.00±0.10	2.00±0.10	1.55±0.10	2.30±0.10	1.50±0.10	3.50±0.10	1.75±0.10	0.60±0.10	/	/
WJC1206	8.00±0.30	4.00±0.10	4.00±0.10	2.00±0.10	2.05±0.20	3.65±0.20	1.50±0.10	3.50±0.10	1.75±0.10	0.60±0.10	/	/

Disclaimer Notice - Information furnished is believed to be accurate and reliable. However, users should independently evaluate the suitability of and test each product selected for their own applications. Littelfuse products are not designed for, and may not be used in, all applications. Read complete Disclaimer Notice at <http://www.littelfuse.com/disclaimer-electronics>.