

**Description**

The A0609CA2LRP is a LCAS protector that does not require an external voltage reference. It specifically provides protection for a balanced ringing system with a ringing voltage range of +54 volts and -78 volts.

This three pin modified DO-214AA solution provides a smaller footprint and lower component count than the typical dual polarity programmable SLIC protector. This new overvoltage protector is applicable for WLL ( Wireless local loops), VoIP (Voice over IP) and regenerated POTS (Plain Old Telephone Systems) applications.

**Agency Approvals**

Agency	Agency File Number
	E133083

**Pinout Designation**

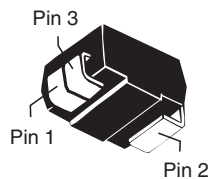

**Features and Benefits**

- Robust surge rating
- Switching speeds of nanoseconds
- Eliminates the need for large, bulky capacitors and blocking diodes required by traditional programmable solutions
- Solid-State transient protection
- Modified DO-214AA
- Fixed voltage asymmetrical design
- Lower component count solution
- Halogen free and RoHS compliant
- 2nd level interconnect is Pb-free per IPC/ JEDEC J-STD-609A.01

**Schematic Symbol**

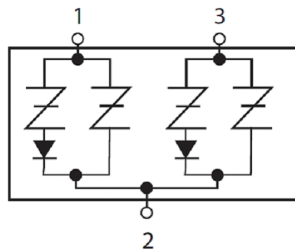

**Applicable Global Standards**

- ITU K.20/21 Enhanced Level\* Edition\*
  - ITU K.20/21 Basic Level
  - GR 1089 Inter-building\*
  - GR 1089 Intra-building
  - IEC 61000-4-5 2nd
  - YD/T 1082
  - YD/T 993
  - YD/T 950
- \* Line impedance required to pass operationally

**Electrical Characteristics**

Part Number	Marking	$V_{DRM}$	$V_S$	$V_{DRM}$	$V_S$	$V_T$	$I_{DRM}$	$I_H$	$I_S$	$I_T$	Capacitance
		@ $I_{DRM}=5\mu A$	@ $100V/\mu s$	@ $I_{DRM}=5\mu A$	@ $100V/\mu s$	@ $I_T=2.2 A$					@ 1MHz, 3V bias
		V min	V max	V min	V max	V max	$\mu A$	mA min	mA max	A max	pF typ
A0609CA2LRP	A0609A	54*	95*	78**	120**	4	5	120	800	2.2	32

Notes:  
- Absolute maximum ratings measured at  $T_A = 25^\circ C$  (unless otherwise noted).  
- Component is asymmetrical

\* Positive voltage threshold  
\*\* Negative voltage threshold

**Surge Ratings**

Series	$I_{PP}$			$I_{TSM}$ 50/60 Hz	di/dt
	8/20 <sup>1</sup> 1.2/50 <sup>2</sup>	10/1000 <sup>1</sup> 10/1000 <sup>2</sup>	5/310 <sup>1</sup> 10/700 <sup>2</sup>		
	A min	A min	A min		
A	150	50	100	12	500

Notes:

- 1 Current waveform in  $\mu s$
  - 2 Voltage waveform in  $\mu s$
- Peak pulse current rating ( $I_{pp}$ ) is repetitive and guaranteed for the life of the product.  
 -  $I_{PP}$  ratings applicable over temperature range of  $-40^{\circ}C$  to  $+85^{\circ}C$   
 - The component must initially be in thermal equilibrium with  $-40^{\circ}C \leq T_J \leq +150^{\circ}C$

**Thermal Considerations**

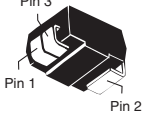
Package	Symbol	Parameter	Value	Unit
Modified DO-214AA Pin 3  Pin 1 Pin 2	$T_J$	Operating Junction Temperature Range	-40 to +150	$^{\circ}C$
	$T_S$	Storage Temperature Range	-65 to +150	$^{\circ}C$
	$R_{\theta JA}$	Thermal Resistance: Junction to Ambient	85	$^{\circ}C/W$

**V-I Characteristics**

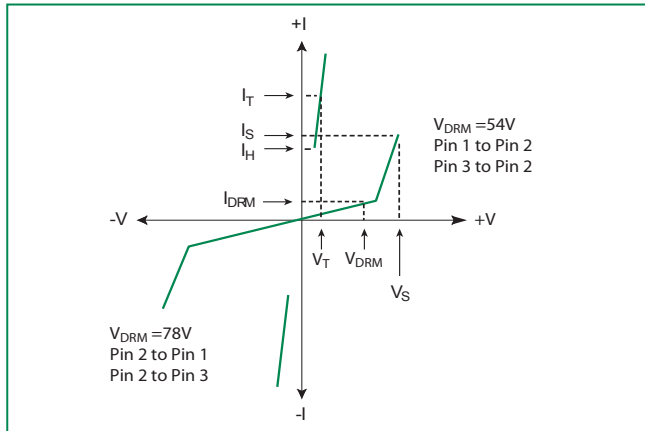

**$t_r \times t_d$  Pulse Waveform**

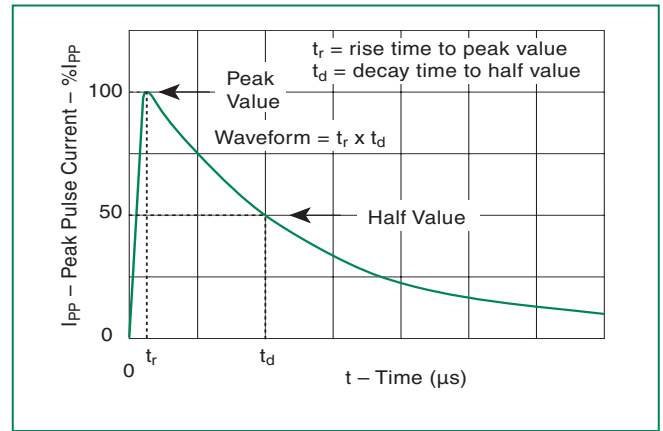

**Normalized  $V_S$  Change vs. Junction Temperature**

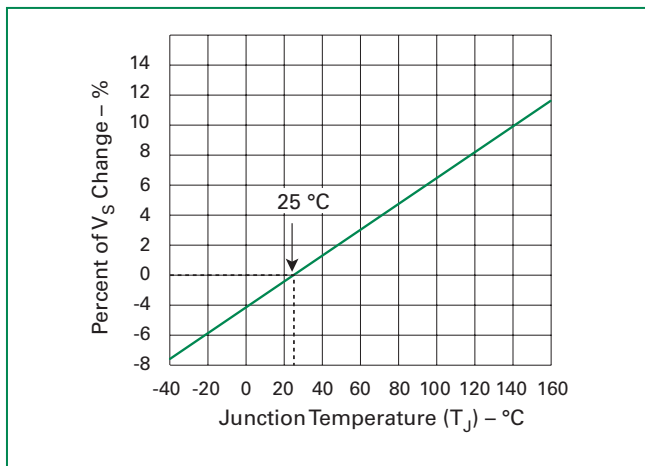

**Normalized DC Holding Current vs. Case Temperature**

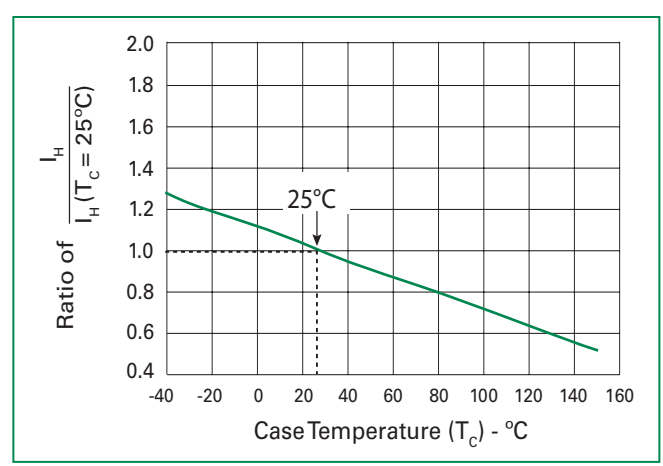

**Soldering Parameters**

Reflow Condition		Pb-Free assembly (see Fig. 1)
Pre Heat	-Temperature Min ( $T_{s(min)}$ )	+150°C
	-Temperature Max ( $T_{s(max)}$ )	+200°C
	-Time (Min to Max) ( $t_s$ )	60-180 secs.
Average ramp up rate (Liquidus Temp ( $T_L$ ) to peak)		3°C/sec. Max.
$T_{s(max)}$ to $T_L$ - Ramp-up Rate		3°C/sec. Max.
Reflow	-Temperature ( $T_L$ ) (Liquidus)	+217°C
	-Temperature ( $t_L$ )	60-150 secs.
Peak Temp ( $T_p$ )		+260(+0/-5)°C
Time within 5°C of actual Peak Temp ( $t_p$ )		30 secs. Max.
Ramp-down Rate		6°C/sec. Max.
Time 25°C to Peak Temp ( $T_p$ )		8 min. Max.
Do not exceed		+260°C

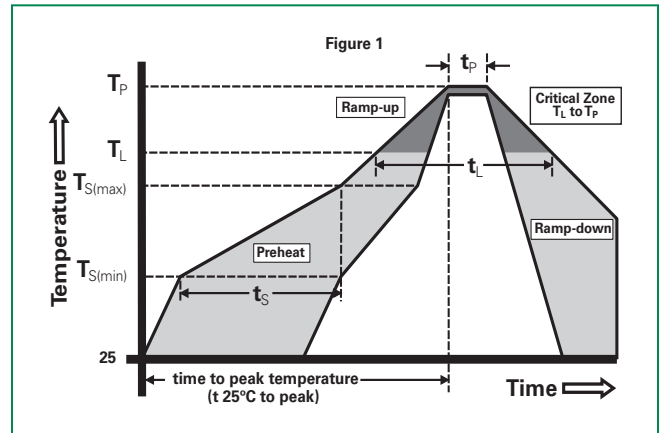

**Physical Specifications**

<b>Lead Material</b>	Copper Alloy
<b>Terminal Finish</b>	100% Matte-Tin Plated
<b>Body Material</b>	UL Recognized epoxy meeting flammability classification V-0

**Environmental Specifications**

<b>High Temp Voltage Blocking</b>	80% Rated $V_{DRM}$ ( $V_{AC}$ Peak) +125°C or +150°C, 504 or 1008 hrs. MIL-STD-750 (Method 1040) JEDEC, JESD22-A-101
<b>Temp Cycling</b>	-65°C to +150°C, 15 min. dwell, 10 up to 100 cycles. MIL-STD-750 (Method 1051) EIA/JEDEC, JESD22-A104
<b>Biased Temp &amp; Humidity</b>	52 $V_{DC}$ (+85°C) 85%RH, 504 up to 1008 hrs. EIA/JEDEC, JESD22-A-101
<b>High Temp Storage</b>	+150°C 1008 hrs. MIL-STD-750 (Method 1031) JEDEC, JESD22-A-101
<b>Low Temp Storage</b>	-65°C, 1008 hrs.
<b>Thermal Shock</b>	0°C to +100°C, 5 min. dwell, 10 sec. transfer, 10 cycles. MIL-STD-750 (Method 1056) JEDEC, JESD22-A-106
<b>Autoclave (Pressure Cooker Test)</b>	+121°C, 100%RH, 2atm, 24 up to 168 hrs. EIA/JEDEC, JESD22-A-102
<b>Resistance to Solder Heat</b>	+260°C, 30 secs. MIL-STD-750 (Method 2031)
<b>Moisture Sensitivity Level</b>	85%RH, +85°C, 168 hrs., 3 reflow cycles (+260°C peak). JEDEC-J-STD-020, Level 1

**Part Numbering**

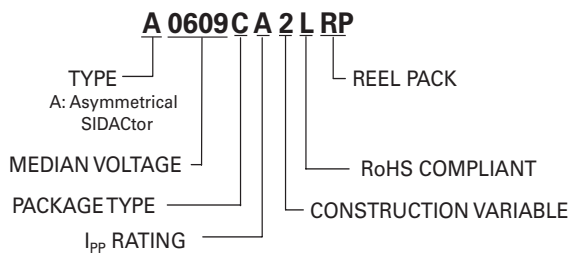

**Part Marking**

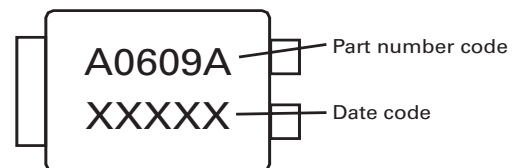

**Dimensions — Modified DO-214AA**

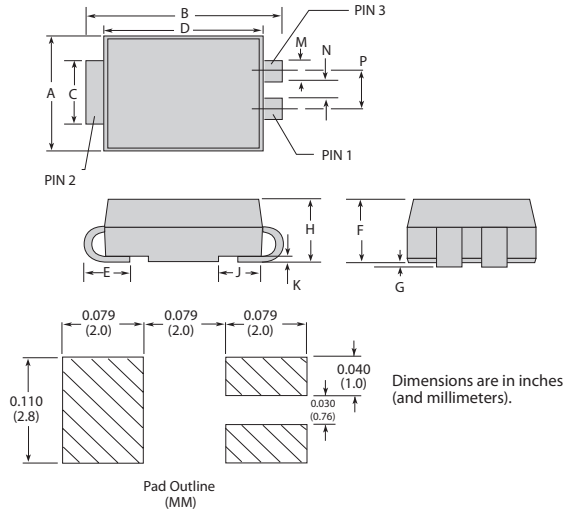

Dimensions	Inches		Millimeters	
	Min	Max	Min	Max
<b>A</b>	0.130	0.156	3.30	3.95
<b>B</b>	0.201	0.220	5.10	5.60
<b>C</b>	0.077	0.087	1.95	2.20
<b>D</b>	0.159	0.181	4.05	4.60
<b>E</b>	0.030	0.063	0.75	1.60
<b>F</b>	0.075	0.096	1.90	2.45
<b>G</b>	0.002	0.008	0.05	0.20
<b>H</b>	0.077	0.104	1.95	2.65
<b>K</b>	0.006	0.016	0.15	0.41
<b>M</b>	0.022	0.028	0.56	0.71
<b>N</b>	0.027	0.033	0.69	0.84
<b>P</b>	0.052	0.058	1.32	1.47

**Packing Options**

Package Type	Description	Quantity	Added Suffix	Industry Standard
C	Modified DO-214AA 3-leaded Tape and Reel Pack	2500	RP	EIA-481-D

**Tape and Reel Specification — Modified DO-214AA**

