

**Battrax® Series - Single Port Negative - MS-013**

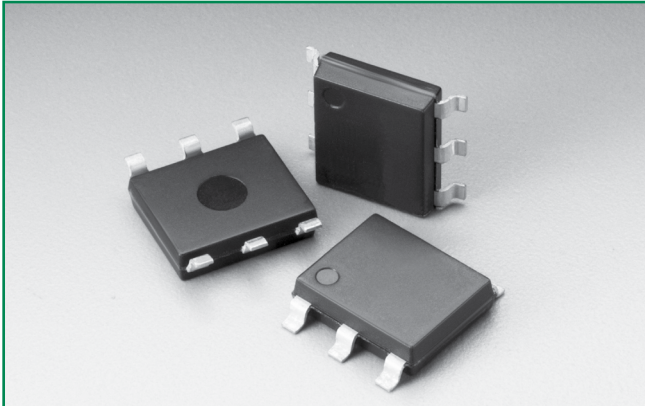

**Agency Approvals**

| Agency | Agency File Number |
|--------|--------------------|
|        | E133083            |

**Pinout Designation**

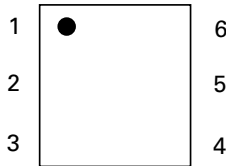

**Schematic Symbol**

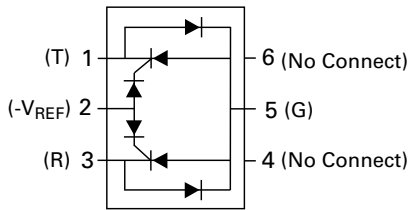

**Description**

The Battrax® Protection Thyristor series offers programmable SIDACtor® overvoltage protection components for SLIC applications. The Single Port Negative Battrax® Protection Thyristor series provides a programmable device that is referenced to a negative voltage source while internal diodes provide protection from positive surge events.

**Features and Benefits**

- Low voltage overshoot device
- Low on-state voltage
- Does not degrade surge capability after multiple surge events within limit.
- Fails short circuit when surged in excess of ratings
- Single-port protection
- Gate triggered tracking
- Integrated diodes for positive voltage protection
- Pb-free E3 means 2nd level interconnect is Pb-free and the terminal finish material is tin(Sn) (IPC/JEDEC J-STD-609A.01)
- RoHS compliant and lead-free

**Applicable Global Standards**

- TIA-968-A
- TIA-968-B
- ITU K.20/21 Enhanced Level
- ITU K.20/21 Basic Level
- GR 1089 Intra-building
- IEC 61000-4-5 2nd edition
- YD/T 1082
- YD/T 993
- YD/T 950

**Additional Information**



**Datasheet**



**Resources**



**Samples**

**Electrical Characteristics**

| Part Number | Marking | $V_{DRM}$              | $V_S$                 | $I_H$  | $I_S$  | $I_T$ | $V_T$              | $V_F$ | Capacitance* |        |
|-------------|---------|------------------------|-----------------------|--------|--------|-------|--------------------|-------|--------------|--------|
|             |         | @ $I_{DRM} = 5\mu A$   | @ 100V/ $\mu s$       | mA min | mA max | A max | @ $I_T = 2.2$ Amps | V max | pF min       | pF max |
| B1101UALxx  | B1101UA | $-V_{REF} + I - 1.2VI$ | $-V_{REF} + I - 10VI$ | 100    | 100    | 2.2   | 4                  | 5     | 30           | 200    |
| B1161UALxx  | B1161UA | $-V_{REF} + I - 1.2VI$ | $-V_{REF} + I - 10VI$ | 160    | 100    | 2.2   | 4                  | 5     | 30           | 200    |
| B1201UALxx  | B1201UA | $-V_{REF} + I - 1.2VI$ | $-V_{REF} + I - 10VI$ | 200    | 100    | 2.2   | 4                  | 5     | 30           | 200    |
| B1101UCLxx  | B1101UC | $-V_{REF} + I - 1.2VI$ | $-V_{REF} + I - 10VI$ | 100    | 100    | 2.2   | 4                  | 5     | 30           | 200    |
| B1161UCLxx  | B1161UC | $-V_{REF} + I - 1.2VI$ | $-V_{REF} + I - 10VI$ | 160    | 100    | 2.2   | 4                  | 5     | 30           | 200    |
| B1201UCLxx  | B1201UC | $-V_{REF} + I - 1.2VI$ | $-V_{REF} + I - 10VI$ | 200    | 100    | 2.2   | 4                  | 5     | 30           | 200    |

Notes:  
 - Absolute maximum ratings measured at  $T_c = 25^\circ C$  (unless otherwise noted).  
 - Components are not appropriate for positive ringing systems.  
 - All electrical characteristics shown are defined from Tip (pin 1) to Ground (pin 5), and Ring (pin 3) to Ground (pin 5)

-  $V_{REF}$  Max Value for the negative Battrax is -200 V.  
 - **XX** = Part Number Suffix: **TP** (Tube Pack) or **RP** (Reel Pack).  
 \* Off-state capacitance ( $C_o$ ) is measured across pins 1 & 5 and 3 & 5 at 1 MHz with a 2V bias.

### Surge Ratings

| Series | $I_{PP}$                                     |  |  |  |  |  |  |  |   | $I_{TSM}$<br>50/60 Hz | di/dt |
|--------|--|--|--|--|--|--|--|--|---|-----------------------|-------|
|        | 0.2/310 <sup>1</sup><br>0.5/700 <sup>2</sup> | 2/10 <sup>1</sup><br>2/10 <sup>2</sup> | 8/20 <sup>1</sup><br>1.2/50 <sup>2</sup> | 10/160 <sup>1</sup><br>10/160 <sup>2</sup> | 10/560 <sup>1</sup><br>10/560 <sup>2</sup> | 5/320 <sup>1</sup><br>9/720 <sup>2</sup> | 10/360 <sup>1</sup><br>10/360 <sup>2</sup> | 10/1000 <sup>1</sup><br>10/1000 <sup>2</sup> | 5/310 <sup>1</sup><br>10/700 <sup>2</sup> |                       |       |
|        | A min  | A min                                  | A min                                    | A min                                      | A min                                      | A min                                    | A min                                      | A min  | A min                                     |                       |       |
| A      | 20   | 150                                    | 150                                      | 90   | 50   | 75                                       | 75   | 45   | 75  | 20                    | 500   |
| C      | 50   | 500                                    | 400                                      | 200  | 150  | 200                                      | 175  | 100  | 200                                       | 50                    | 500   |

Notes:

- 1 Current waveform in  $\mu s$
- 2 Voltage waveform in  $\mu s$
- Peak pulse current rating ( $I_{PP}$ ) is repetitive and guaranteed for the life of the product that remains in thermal equilibrium.
- $I_{PP}$  ratings applicable over temperature range of  $-40^{\circ}C$  to  $+85^{\circ}C$  ( $I_{PP}$  rating assumes  $V_{REF}$  equals -48 V)
- The component must initially be in thermal equilibrium with  $-40^{\circ}C \leq T_J \leq +150^{\circ}C$

### Thermal Considerations

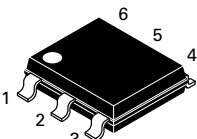
| Package  | Symbol          | Parameter                               | Value       | Unit          |
|--|-----------------|---|-------------|---------------|
| <br>Modified MS-013 | $T_J$           | Operating Junction Temperature Range    | -40 to +125 | $^{\circ}C$   |
|  | $T_S$           | Storage Temperature Range               | -65 to +150 | $^{\circ}C$   |
|  | $R_{\theta JA}$ | Thermal Resistance: Junction to Ambient | 60          | $^{\circ}C/W$ |

### V-I Characteristics

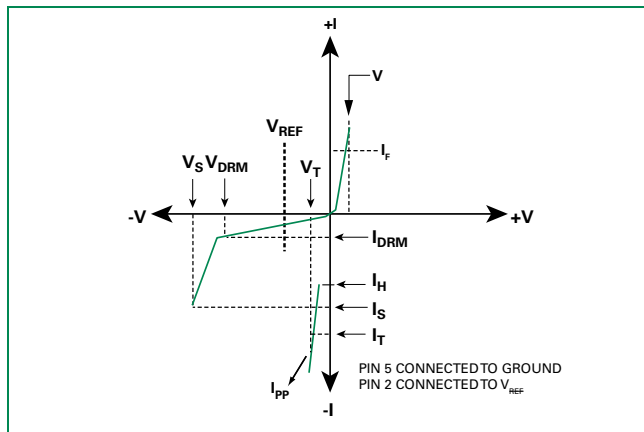

### $t_r \times t_d$ Pulse Waveform

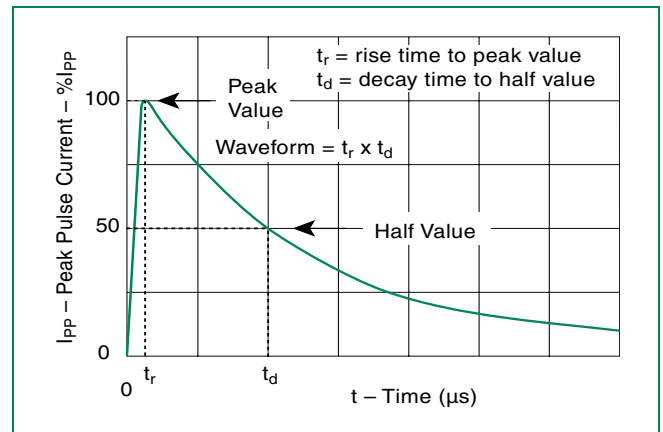

### Normalized $V_S$ Change vs. Junction Temperature

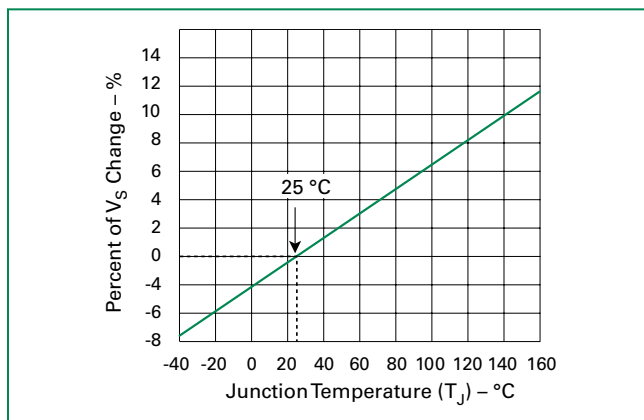

### Normalized DC Holding Current vs. Case Temperature

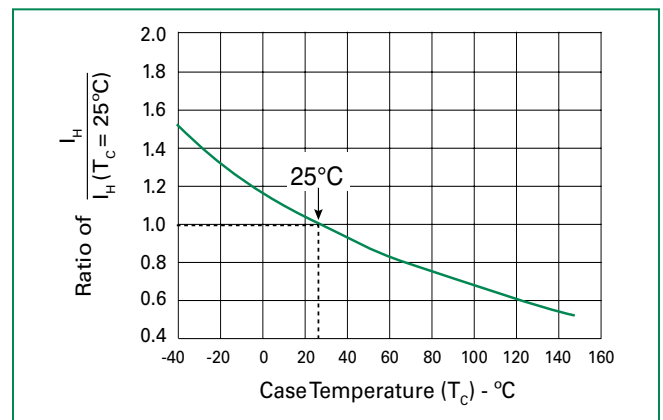

**Soldering Parameters**

|  |                                   |              |
|--|-----------------------------------|--------------|
| Reflow Condition                                       | Pb-Free assembly (see Fig. 1)     |              |
| Pre Heat   | -Temperature Min ( $T_{s(min)}$ ) | +150°C       |
|  | -Temperature Max ( $T_{s(max)}$ ) | +200°C       |
|  | -Time (Min to Max) ( $t_s$ )      | 60-180 secs. |
| Average ramp up rate (Liquidus Temp ( $T_L$ ) to peak) | 3°C/sec. Max.                     |              |
| $T_{s(max)}$ to $T_L$ - Ramp-up Rate                   | 3°C/sec. Max.                     |              |
| Reflow   | -Temperature ( $T_L$ ) (Liquidus) | +217°C       |
|  | -Temperature ( $t_L$ )            | 60-150 secs. |
| Peak Temp ( $T_p$ )                                    | +260(+0/-5)°C                     |              |
| Time within 5°C of actual Peak Temp ( $t_p$ )          | 30 secs. Max.                     |              |
| Ramp-down Rate   | 6°C/sec. Max.                     |              |
| Time 25°C to Peak Temp ( $T_p$ )                       | 8 min. Max.                       |              |
| Do not exceed  | +260°C                            |              |

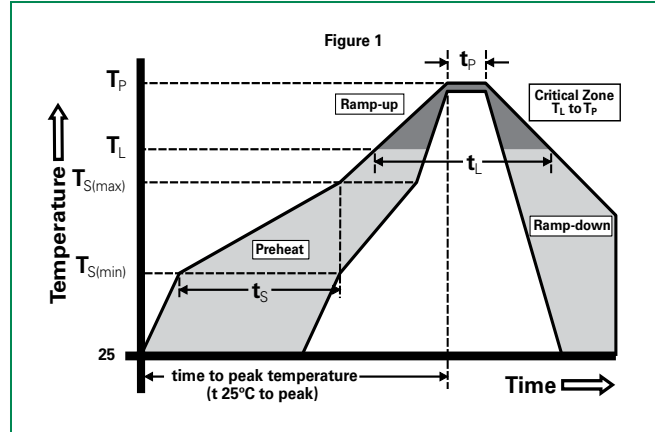

**Physical Specifications**

|                        |   |
|------------------------|---|
| <b>Lead Material</b>   | Copper Alloy  |
| <b>Terminal Finish</b> | 100% Matte-Tin Plated                                       |
| <b>Body Material</b>   | UL Recognized epoxy meeting flammability classification V-0 |

**Environmental Specifications**

|   |  |
|---|--|
| <b>High Temp Voltage Blocking</b>       | 80% Rated $V_{REF}$ Max. ( $V_{DC}$ Peak) +125°C or +150°C, 504 or 1008 hrs. MIL-STD-750 (Method 1040) JEDEC, JESD22-A-101 |
| <b>Temp Cycling</b>                     | -65°C to +150°C, 15 min. dwell, 10 up to 100 cycles. MIL-STD-750 (Method 1051) EIA/JEDEC, JESD22-A104                      |
| <b>Biased Temp &amp; Humidity</b>       | 52 $V_{DC}$ (+85°C) 85%RH, 504 up to 1008 hrs. EIA/JEDEC, JESD22-A-101   |
| <b>High Temp Storage</b>                | +150°C 1008 hrs. MIL-STD-750 (Method 1031) JEDEC, JESD22-A-101   |
| <b>Low Temp Storage</b>                 | -65°C, 1008 hrs.   |
| <b>Thermal Shock</b>                    | 0°C to +100°C, 5 min. dwell, 10 sec. transfer, 10 cycles. MIL-STD-750 (Method 1056) JEDEC, JESD22-A-106                    |
| <b>Autoclave (Pressure Cooker Test)</b> | +121°C, 100%RH, 2atm, 24 up to 168 hrs. EIA/JEDEC, JESD22-A-102  |
| <b>Resistance to Solder Heat</b>        | +260°C, 30 secs. MIL-STD-750 (Method 2031)   |
| <b>Moisture Sensitivity Level</b>       | 85%RH, +85°C, 168 hrs., 3 reflow cycles (+260°C Peak). JEDEC-J-STD-020, Level 1  |

**Part Numbering**

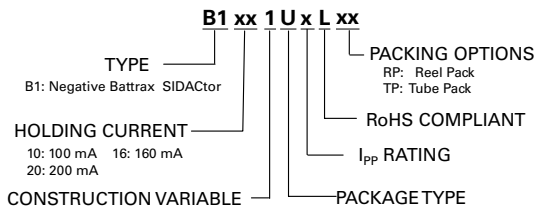

**Part Marking**

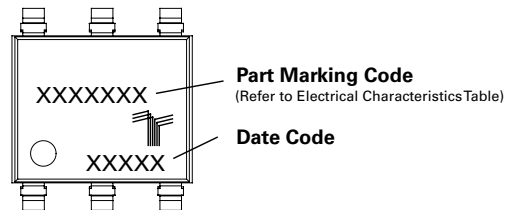

**Dimensions — MS-013**

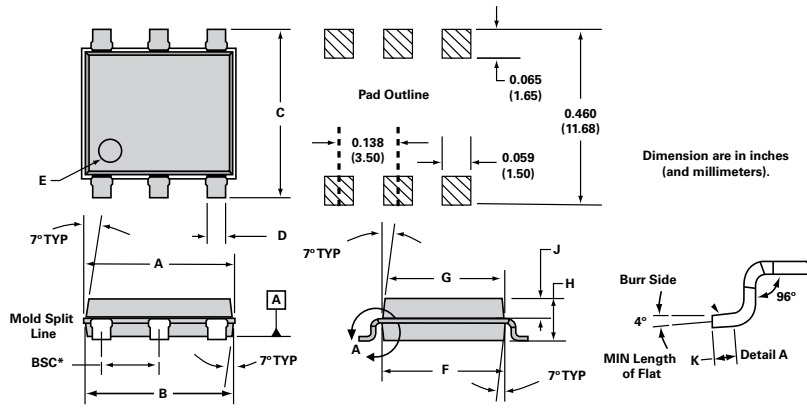

| Dimensions  | Inches |       | Millimeters |       |
|-------------|--------|-------|-------------|-------|
|             | Min    | Max   | Min         | Max   |
| <b>A</b>    | 0.360  | 0.364 | 9.14        | 9.25  |
| <b>B</b>    | 0.352  | 0.356 | 8.94        | 9.04  |
| <b>C</b>    | 0.400  | 0.412 | 10.16       | 10.46 |
| <b>D</b>    | 0.043  | 0.045 | 1.09        | 1.13  |
| <b>E</b>    | 0.047  | 0.055 | 1.19        | 1.40  |
| <b>F</b>    | 0.293  | 0.297 | 7.44        | 7.54  |
| <b>G</b>    | 0.289  | 0.293 | 7.34        | 7.44  |
| <b>H</b>    | 0.089  | 0.093 | 2.26        | 2.36  |
| <b>J</b>    | 0.041  | 0.049 | 1.04        | 1.24  |
| <b>K</b>    | 0.020  |       | 0.51        |       |
| <b>BSC*</b> | 0.133  | 0.143 | 3.38        | 3.63  |

\* BSC = Basic Spacing between Centers

**Packing Options**

| Package Type | Description                              | Quantity          | Added Suffix | Industry Standard |
|--------------|--|-------------------|--------------|-------------------|
| U            | Modified MS-013 6-pin Tape and Reel Pack | 1500              | RP           | EIA-481-D         |
|              | Modified MS-013 6-pin Tube Pack          | 500 (50 per tube) | TP           | N/A               |

**Tape and Reel Specification — MS-013**

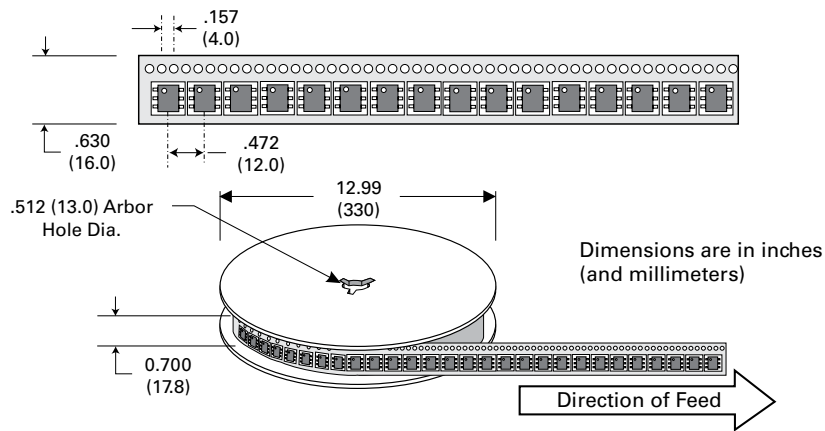

**Tube Pack Specification — MS-013**

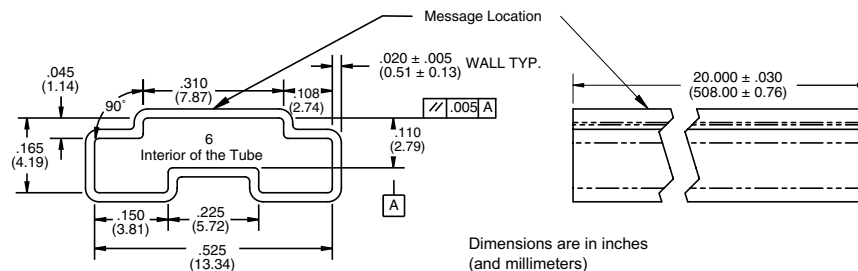

**Disclaimer Notice - Information furnished is believed to be accurate and reliable. However, users should independently evaluate the suitability of and test each product selected for their own applications. Littelfuse products are not designed for, and may not be used in, all applications. Read complete Disclaimer Notice at [www.littelfuse.com/disclaimer-electronics](http://www.littelfuse.com/disclaimer-electronics).**