

Pxxx0SD

High Surge Current SIDACtor® - DO-214AA



Description

Pxxx0SD Series are SIDACtor® thyristors designed to protect equipment located in hostile environments from overvoltage transients.

The series provides a 200A 10/1000 rated surge current capability that enables equipment to comply with enhanced surge requirements now specified in regulatory and customer requirements.

Features & Benefits

- Low voltage overshoot
- Low on-state voltage
- Does not degrade surge capability after multiple surge events within limit.
- Fails short circuit when surged in excess of ratings
- 200A 10/1000 Surge Rating
- 1000A 2/10 Surge Rating
- RoHS Compliant and Halogen-Free
- Pb-free E3 means 2nd level interconnect is Pb-free and the terminal finish material is tin(Sn) (IPC/JEDEC J-STD-609A.01)
- UL Recognized to UL 497B
- Aids compliance to 2 kV CWG surge per IEC 61000-4-5 when used in series with an appropriate OVP clamp device*

Note: * SIDACtor connected in-series with a Littelfuse MOV and this complete circuit provides both overcurrent and overvoltage protection for the AC line.

Web Resources



Download ECAD models, order samples, and find technical resources at www.littelfuse.com

Agency Approvals

Agency	Agency File Number
	E133083

Schematic Symbol



Pinout Designation

Not Applicable

Applicable Global Standards

- TIA-968-A
- TIA-968-B
- ITU K.20/21/45 Enhanced Level
- ITU K.20/21/45 Basic Level
- GR 1089 Inter-building
- GR 1089 Intra-building
- IEC 61000-4-5 2nd edition
- YD/T 1082
- YD/T 993
- YD/T 950

Electrical Characteristics

Part Number	Marking	V_{DRM} @ $I_{DRM}=5\mu A$	V_s @ 100V/ μs	I_H	I_s	$I_{T^{**}}$	V_T @ $I_T=2.2A$	Capacitance @ 1MHz, 2V bias	
		V min	V max	mA min	mA max	A max	V max	pf min	pF max
P0080SDLRP	P-8D	6	25	50	800	2.2	4	50	150
P0640SDLRP	P06D	58	77	50	800	2.2	4	100	160
P0720SDLRP	P07D	65	88	50	800	2.2	4	100	150
P0900SDLRP	P09D	75	98	50	800	2.2	4	95	140
P1100SDLRP	P11D	90	130	50	800	2.2	4	75	115
P1300SDLRP	P13D	120	160	50	800	2.2	4	65	100
P1500SDLRP	P15D	140	180	50	800	2.2	4	60	90
P1800SDLRP	P18D	170	220	50	800	2.2	4	50	90
P2300SDLRP	P23D	190	260	50	800	2.2	4	50	80
P2600SDLRP	P26D	220	300	50	800	2.2	4	50	75
P3100SDLRP	P31D	275	350	50	800	2.2	4	45	70
P3500SDLRP	P35D	320	400	50	800	2.2	4	45	65

Notes:

- Absolute maximum ratings measured at $T_c=25^\circ C$ (unless otherwise noted).
- Components are bi-directional (unless otherwise noted).
- ** Will meet 4.4A power cross requirement without fire hazard.

Pxxx0SD

High Surge Current SIDACtor® - DO-214AA

Surge Ratings

Series	I_{PP}									I_{TSM} 50/60 Hz	di/dt
	0.2/310 ¹ 0.5/700 ² A min	2/10 ¹ 2/10 ² A min	8/20 ¹ 1.2/50 ² A min	10/160 ¹ 10/160 ² A min	10/560 ¹ 10/560 ² A min	5/320 ¹ 9/720 ² A min	10/360 ¹ 10/360 ² A min	10/1000 ¹ 10/1000 ² A min	5/310 ¹ 10/700 ² A min		
D	—	1000	800 ³	—	—	—	—	200	350	50	1000

Notes:

- Current waveform in μs
 - Voltage waveform in μs
 - Designed to withstand a 2.0 kV (1.2/50 voltage, 8/20 current) combination wave surge per IEC 61000-4-5 level 3 when used in series with an appropriate overvoltage clamp device. (Detail refer to file "High Power Semiconductor Crowbar Protector for AC Power Line Applications"
- Peak pulse current rating (IPP) is repetitive and guaranteed for the life of the product that remains in thermal equilibrium.
 - IPP ratings applicable over temperature range of -40°C to +85°C
 - The component must initially be in thermal equilibrium with -40°C < T_J < +150°C

Thermal Considerations

Package	Symbol	Parameter	Value	Unit
 DO-214AA	T _J	Operating Junction Temperature Range	-40 to +150	°C
	T _S	Storage Temperature Range	-65 to +150	°C
	R _{θJA}	Thermal Resistance: Junction to Ambient	90	°C/W

V-I Characteristics

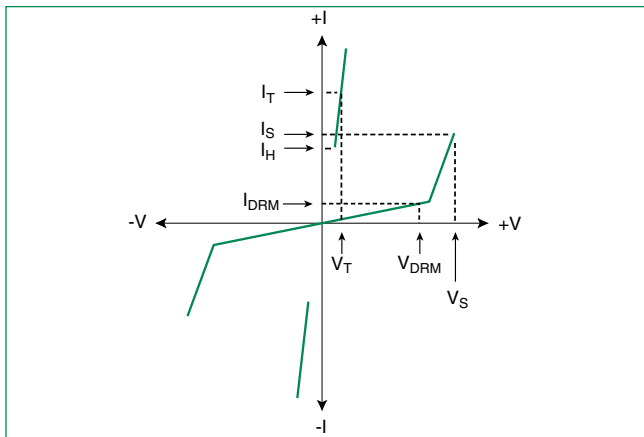

tr x td Pulse Waveform

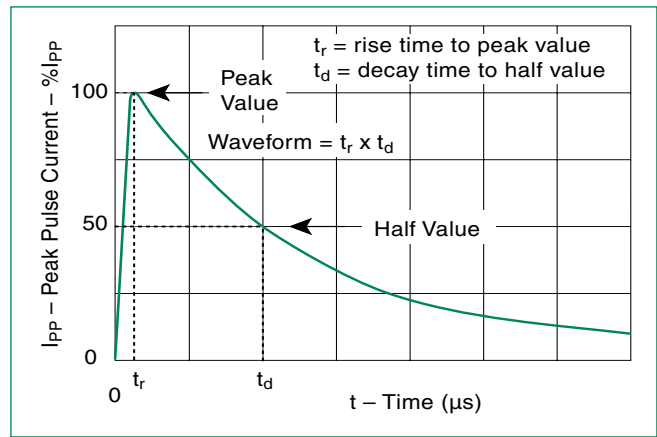

Normalized V_S Change vs. Junction Temperature

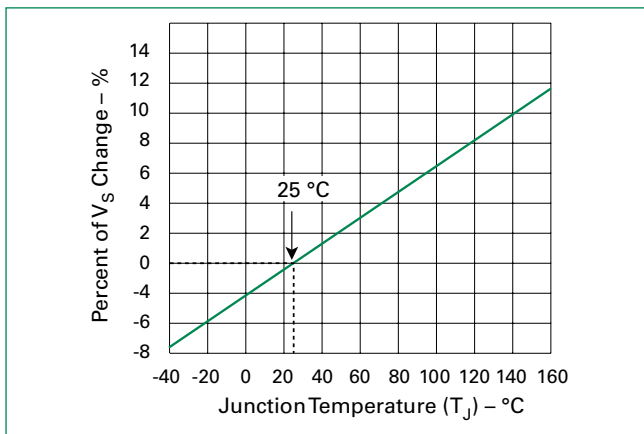

Normalized DC Holding Current vs. Case Temperature

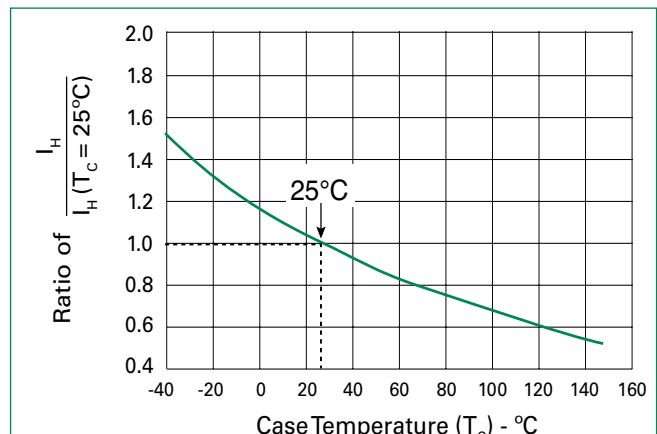

Pxxx0SD

High Surge Current SIDACtor® - DO-214AA

Soldering Parameters

Reflow Condition		Pb-Free assembly (see Fig. 1)
Pre Heat	- Temperature Min ($T_{s(min)}$)	+150°C
	- Temperature Max ($T_{s(max)}$)	+200°C
	- Time (Min to Max) (t_s)	60-180 secs.
Average ramp up rate (Liquidus Temp (T_L) to peak)		3°C/sec. Max.
$T_{s(max)}$ to T_L - Ramp-up Rate		3°C/sec. Max.
Reflow	- Temperature (T_L) (Liquidus)	+217°C
	- Temperature (t_L)	60-150 secs.
Peak Temp (T_p)		+260(+0/-5)°C
Time within 5°C of actual Peak Temp (t_p)		30 secs. Max.
Ramp-down Rate		6°C/sec. Max.
Time 25°C to Peak Temp (T_p)		8 min. Max.
Do not exceed		+260°C

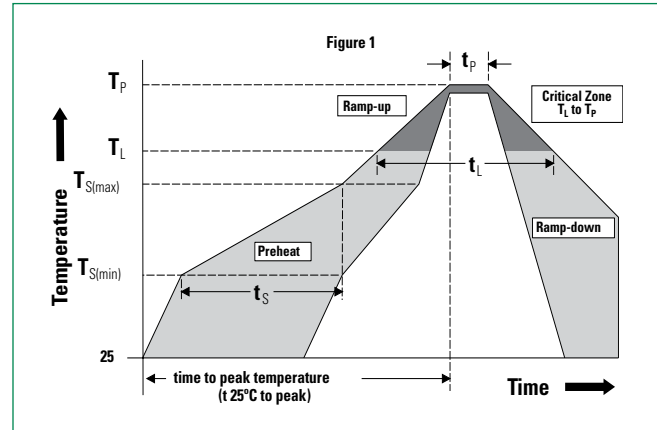

Physical Specifications

Lead Material	Copper Alloy
Terminal Finish	100% Matte-Tin Plated
Body Material	UL Recognized epoxy meeting flammability classification V-0 per UL 94

Environmental Specifications

High Temp Voltage Blocking	80% Rated V_{DRM} (V_{AC} Peak) +125°C or +150°C, 504 or 1008 hrs. MIL-STD-750 (Method 1040) JEDEC, JESD22-A-101
Temp Cycling	-65°C to +150°C, 15 min. dwell, 10 up to 100 cycles. MIL-STD-750 (Method 1051) EIA/JEDEC, JESD22-A104
Biased Temp & Humidity	52 V_{DC} (+85°C) 85%RH, 504 up to 1008 hrs. EIA/JEDEC, JESD22-A-101
High Temp Storage	+150°C 1008 hrs. MIL-STD-750 (Method 1031) JEDEC, JESD22-A-101
Low Temp Storage	-65°C, 1008 hrs.
Thermal Shock	0°C to +100°C, 5 min. dwell, 10 sec. transfer, 10 cycles. MIL-STD-750 (Method 1056) JEDEC, JESD22-A-106
Autoclave (Pressure Cooker Test)	+121°C, 100%RH, 2atm, 24 up to 168 hrs. EIA/JEDEC, JESD22-A-102
Resistance to Solder Heat	+260°C, 30 secs. MIL-STD-750 (Method 2031)
Moisture Sensitivity Level	85%RH, +85°C, 168 hrs., 3 reflow cycles (+260°C Peak). JEDEC-J-STD-020, Level 1

Part Numbering

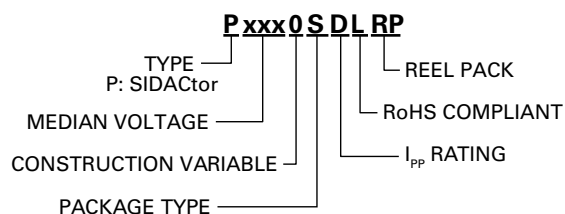

Part Marking

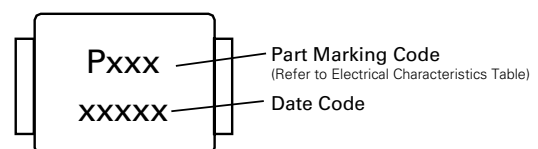

Pxxx0SD

High Surge Current SIDACtor® - DO-214AA

Dimensions – DO-214AA

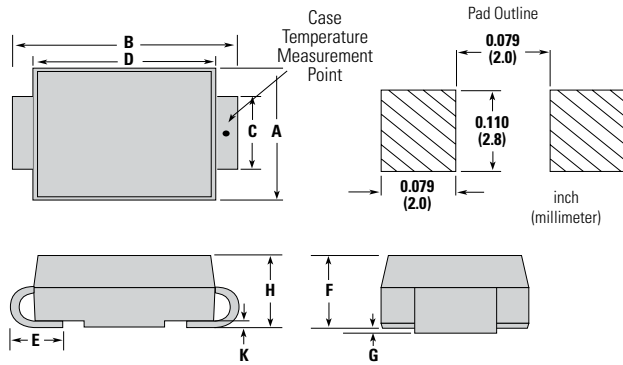

Dimensions	Inches		Millimeters	
	Min	Max	Min	Max
A	0.130	0.156	3.30	3.95
B	0.201	0.220	5.10	5.60
C	0.077	0.087	1.95	2.20
D	0.159	0.181	4.05	4.60
E	0.030	0.063	0.75	1.60
F	0.075	0.096	1.90	2.45
G	0.002	0.008	0.05	0.20
H	0.077	0.104	1.95	2.65
K	0.006	0.016	0.15	0.41

Packing Options

Package Type	Description	Quantity	Added Suffix	Industry Standard
S	DO-214AA Tape and Reel Pack	2500	RP	EIA-481-D

Tape and Reel Specification – DO-214AA

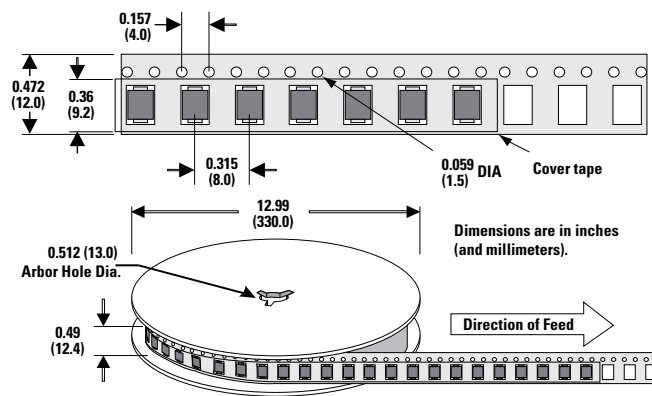

Disclaimer Notice - Information furnished is believed to be accurate and reliable. However, users should independently evaluate the suitability of and test each product selected for their own applications. Littelfuse products are not designed for, and may not be used in, all applications. Read complete Disclaimer Notice at www.littelfuse.com/disclaimer-electronics.