

SDPXXX0Q38CX -SDP Biased Series - 5x6 QFN for DSL Protection

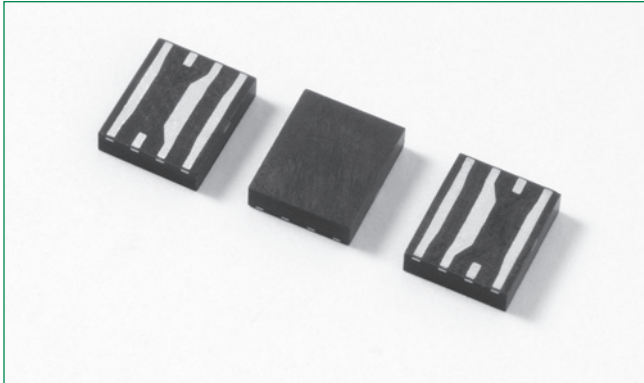

Description

This new SDP (SIDACtor DSL Protector) Biased series provides overvoltage protection for applications such as VDSL2, ADSL2, and ADSL2+ with minimal effect on data signals. This latest silicon design innovation results in a capacitive loading characteristic that is compatible with these high bandwidth applications. This surface mount QFN package provides a surge capability that exceeds most worldwide standards and recommendations for lightning surge withstand capability of secondary protectors.

Features & Benefits

- Compatible with VDSL2 (30MHz)
- Balanced overvoltage protection
- Low distortion
- Low insertion loss
- Low profile
- SO-8 footprint compatible
- Fails short circuit when surged in excess of ratings
- 2nd level interconnect is Pb-free per IPC/JEDEC J-STD-609A.01
- Recognized to UL 497B as an Isolated Loop Circuit Protector
- Halogen-free and RoHS compliant

Agency Approvals

Agency	Agency File Number
	E133083

Pinout Designation

Tip in	1	8	Tip out
- Bias	2	7	+ Bias
Ground	3	6	Ground
Ring in	4	5	Ring out

Schematic Symbol

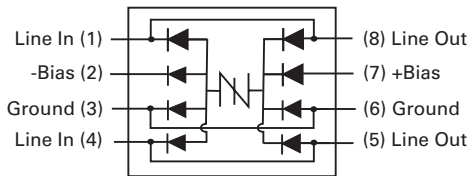

Applicable Global Standards

- TIA-968-A
- TIA-968-B
- ITU K.20/21 Enhanced Level
- ITU K.20/21 Basic Level
- IEC 61000-4-5, 2nd Edition
- GR 1089 Inter-building
- GR 1089 Intra-building
- YD/T 1082
- YD/T 993
- YD/T 950

Electrical Characteristics

Part Number	Marking	$V_{DRM}@I_{DRM}=5\mu A$	$V_s@100V/\mu s$	I_H	I_s	I_T	$V_T@I_T=2.2$ Amps	Capacitance
		V min	V max	mA min	mA max	A max	V max	
SDP0080Q38CB	SDP-8C	6	25	50	800	2.2	8	See Capacitance vs Voltage Chart
SDP0220Q38CB	SDP02C	16	30	50	800	2.2	8	
SDP0640Q38CB	SDP06C	58	77	150	800	2.2	8	
SDP0720Q38CB	SDP07C	65	88	150	800	2.2	8	
SDP0900Q38CB	SDP09C	75	98	150	800	2.2	8	
SDP1100Q38CB	SDP11C	90	130	150	800	2.2	8	
SDP1300Q38CB	SDP13C	120	160	150	800	2.2	8	
SDP1800Q38CB	SDP18C	170	220	150	800	2.2	8	
SDP2600Q38CB	SDP26C	220	300	150	800	2.2	8	
SDP3100Q38CB	SDP31C	275	350	150	800	2.2	8	
SDP3500Q38CB	SDP35C	320	400	150	800	2.2	8	

Notes:
 - Absolute maximum ratings measured at $T_A=25^\circ C$ (unless otherwise noted).
 - Devices are bi-directional (unless otherwise noted).

V-I: Characteristics

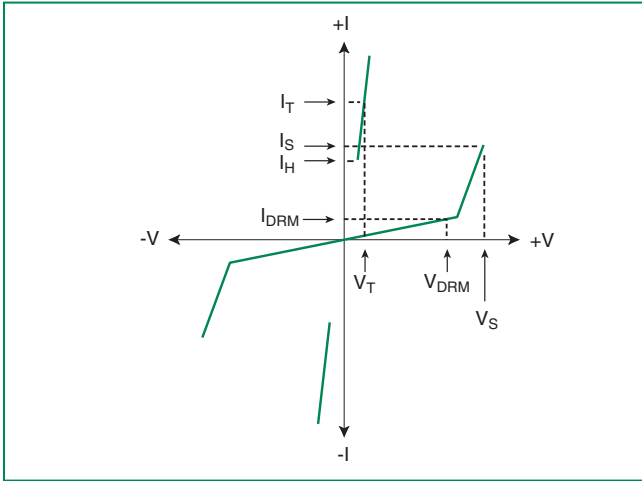

Capacitance vs. Voltage*

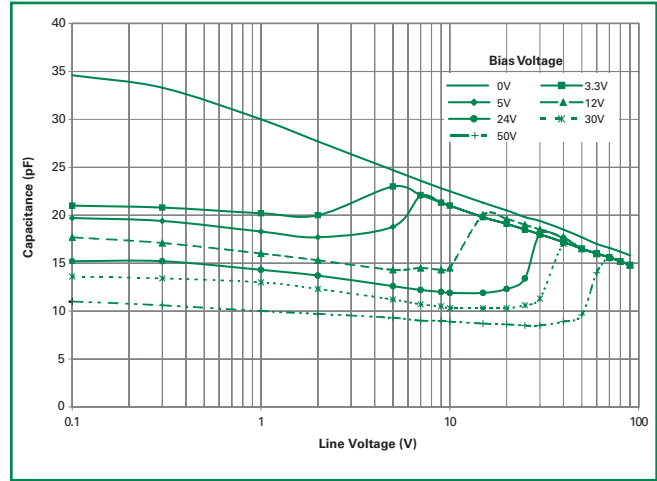

* Bias voltage must be lower than V_{DRM}

50/60Hz Ratings

Parameter Name	Test Conditions	Value	Units
I_{TSM} Maximum non-repetitive on-state current, 50/60Hz	0.5s	6.5	A
	1s	4.6	
	2s	3.4	
	5s	2.3	
	30s	1.3	
	900s	0.73	

Surge Ratings

Series	I_{PP}				I_{TSM}
	2x10 μ s	1.2x50 μ s/8x20 μ s	10x700/5x310 μ s	10x1000 μ s	600V _{RMS} 1 cycle
	A min	A min	A min	A min	A _{RMS}
C	500	400	200	100	30

Notes:

- Peak pulse current rating (I_{pp}) is repetitive and guaranteed for the life of the product.
- I_{pp} ratings applicable over temperature range of -40°C to +85°C
- The device must initially be in thermal equilibrium with -40°C \leq T_J \leq +150°C

Thermal Considerations

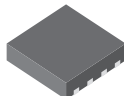
Package	Symbol	Parameter	Value	Unit
 5x6 QFN	T_J	Junction Temperature	-40 to +150	°C
	T_{STG}	Storage Temperature Range	-40 to +150	°C
	$R_{\theta JA}$	Thermal Resistance: Junction to Ambient	100	°C/W

Normalized V_s Change vs. Junction Temperature

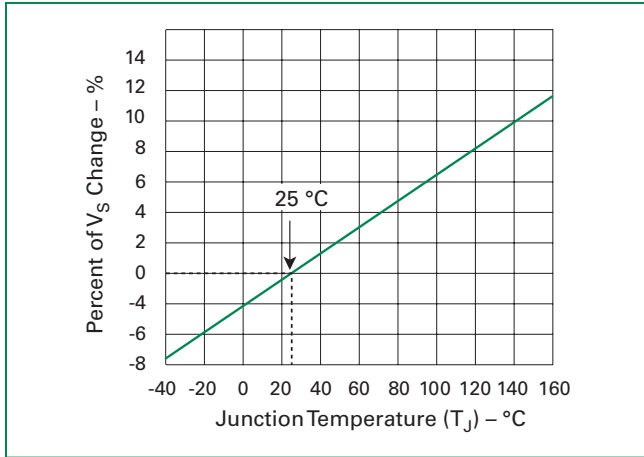

Normalized DC Holding Current vs. Case Temperature

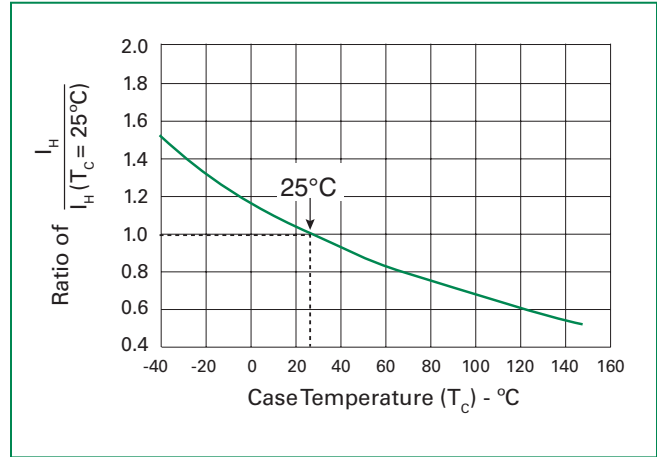

Soldering Parameters

Reflow Condition	Pb-Free assembly (see Fig. 1)	
Pre Heat	- Temperature Min ($T_{s(\text{min})}$)	+150°C
	- Temperature Max ($T_{s(\text{max})}$)	+200°C
	- Time (Min to Max) (t_s)	60-180 secs.
Average ramp up rate (Liquidus Temp (T_L) to peak)	3°C/sec. Max.	
$T_{s(\text{max})}$ to T_L - Ramp-up Rate	3°C/sec. Max.	
Reflow	- Temperature (T_i) (Liquidus)	+217°C
	- Temperature (t_L)	60-150 secs.
Peak Temp (T_p)	+260(+0/-5)°C	
Time within 5°C of actual Peak Temp (t_p)	30 secs. Max.	
Ramp-down Rate	6°C/sec. Max.	
Time 25°C to Peak Temp (T_p)	8 min. Max.	
Do not exceed	+260°C	

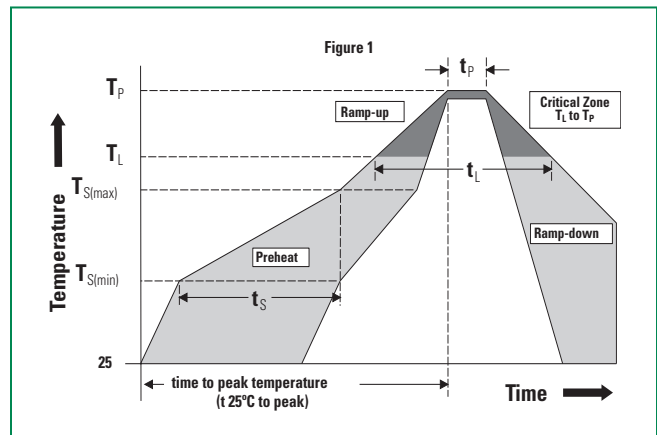

Physical Specifications

Lead Material	Copper Alloy
Terminal Finish	100% Matte-Tin Plated
Body Material	UL Recognized epoxy meeting flammability classification 94V-0

Additional Information



Datasheet



Resources



Samples

Environmental Specifications

High Temp Voltage Blocking	80% Rated V_{DRM} ($V_{\text{AC Peak}}$) +125°C or +150°C, 504 or 1008 hrs. MIL-STD-750 (Method 1040) JEDEC, JESD22-A-101
Temp Cycling	-65°C to +150°C, 15 min. dwell, 10 up to 100 cycles. MIL-STD-750 (Method 1051) EIA/JEDEC, JESD22-A104
Biased Temp & Humidity	52 V_{DC} (+85°C) 85% RH, 504 up to 1008 hrs. EIA/JEDEC, JESD22-A-101
High Temp Storage	+150°C 1008 hrs. MIL-STD-750 (Method 1031) JEDEC, JESD22-A-101
Low Temp Storage	-65°C, 1008 hrs.
Thermal Shock	0°C to +100°C, 5 min. dwell, 10 sec. transfer, 10 cycles. MIL-STD-750 (Method 1056) JEDEC, JESD22-A-106
Resistance to Solder Heat	+260°C, 30 secs. MIL-STD-750 (Method 2031)
Moisture Sensitivity Level	85% RH, +85°C, 168 hrs., 3 reflow cycles (+260°C Peak). JEDEC-J-STD-020, Level 1

Dimensions — 5x6 QFN

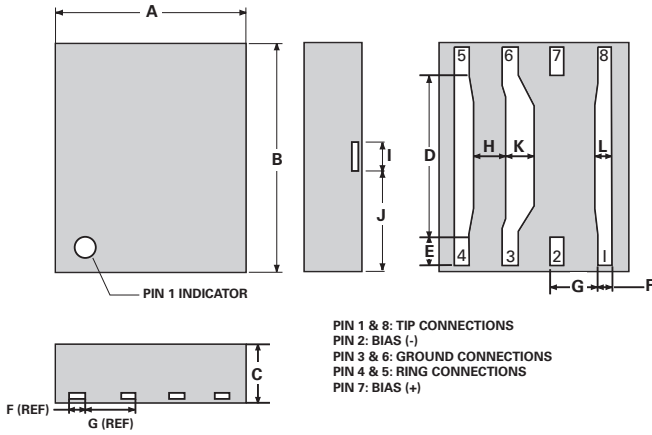

Dimension	Inches		Millimeters	
	Min	Max	Min	Max
A	0.187	0.207	4.745	5.253
B	0.226	0.246	5.745	6.253
C	0.054	0.064	1.374	1.628
D	0.165	0.171	4.199	4.351
E	0.027	0.033	0.686	0.838
F	0.011	0.017	0.279	0.432
G	0.047	0.053	1.194	1.346
H	0.032	0.038	0.800	0.953
I	0.027	0.033	0.686	0.838
J	0.100	0.106	2.540	2.692
K	0.027	0.033	0.686	0.838
L	0.015	0.021	0.381	0.533

5x6 QFN Solder Pad Layout

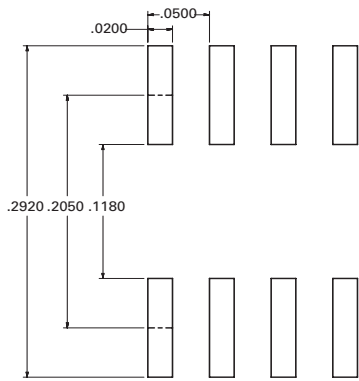

Part Numbering

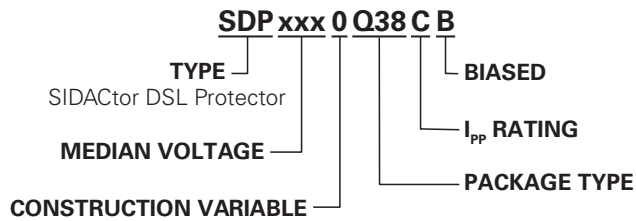

Part Marking

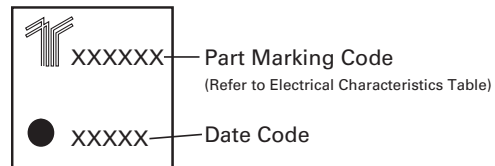

Packing Options

Package Type	Description	Quantity	Added Suffix	Industry Standard
Q38	5x6x1.5 QFN Tape and Reel Pack	4000	N/A	EIA-481-D

Tape and Reel Specifications — 5x6 QFN

Reel Dimension

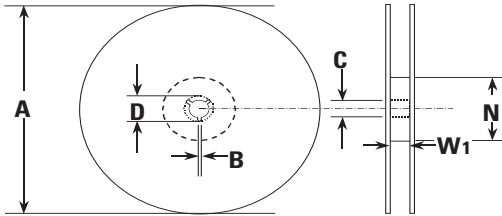

Tape Leader and Trailer Dimensions

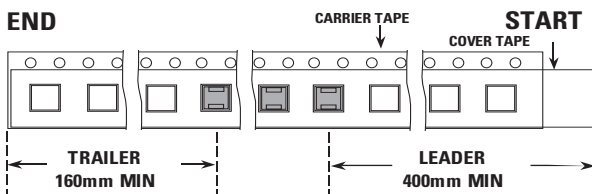

Tape Dimension Items

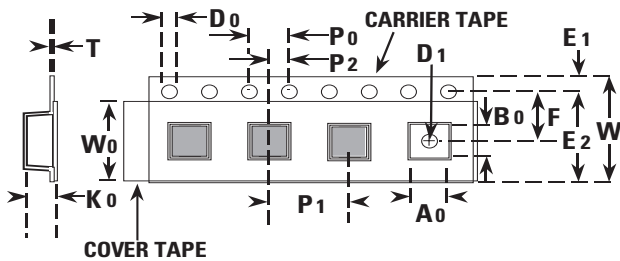

Symbols	Description	Inches		Millimeters	
		Min	Max	Min	Max
A	Reel Diameter	N/A	12.992	N/A	330.0
B	Drive Spoke Width	0.059	N/A	1.50	N/A
C	Arbor Hole Diameter	0.504	0.531	12.80	13.50
D	Drive Spoke Diameter	0.795	N/A	20.20	N/A
N	Hub Diameter	1.969	N/A	50.00	N/A
W ₁	Reel Inner Width at Hub	0.488	0.567	12.40	14.40
A ₀	Pocket Width at Bottom	0.204	0.212	5.20	5.40
B ₀	Pocket Length at Bottom	0.244	0.252	6.20	6.40
D ₀	Feed Hole Diameter	0.059	0.063	1.50	1.60
D ₁	Pocket Hole Diameter	0.059	N/A	1.50	N/A
E ₁	Feed Hole Position 1	0.065	0.073	1.65	1.85
E ₂	Feed Hole Position 2	0.400	0.408	10.15	10.35
F	Feed Hole Center - Pocket Hole Center 2	0.212	0.220	5.40	5.60
K ₀	Pocket Depth	0.067	0.075	1.70	1.90
P ₀	Feed Hole Pitch	0.153	0.161	3.90	4.10
P ₁	Component Spacing	0.311	0.319	7.90	8.10
P ₂	Feed Hole Center - Pocket Hole Center 1	0.077	0.081	1.90	2.10
T	Carrier Tape Thickness	0.010	0.014	0.25	0.35
W	Embossed Carrier Tape Width	0.460	0.484	11.70	12.30
W ₀	Cover Tape Width	0.358	0.366	9.10	9.30

Disclaimer Notice - Littelfuse products are not designed for, and shall not be used for, any purpose (including, without limitation, automotive, military, aerospace, medical, life-saving, life-sustaining or nuclear facility applications, devices intended for surgical implant into the body, or any other application in which the failure or lack of desired operation of the product may result in personal injury, death, or property damage) other than those expressly set forth in applicable Littelfuse product documentation. Warranties granted by Littelfuse shall be deemed void for products used for any purpose not expressly set forth in applicable Littelfuse documentation. Littelfuse shall not be liable for any claims or damages arising out of products used in applications not expressly intended by Littelfuse as set forth in applicable Littelfuse documentation. The sale and use of Littelfuse products is subject to Littelfuse Terms and Conditions of Sale, unless otherwise agreed by Littelfuse. "Littelfuse" includes Littelfuse, Inc., and all of its affiliate entities. <http://www.littelfuse.com/disclaimer-electronics>.