

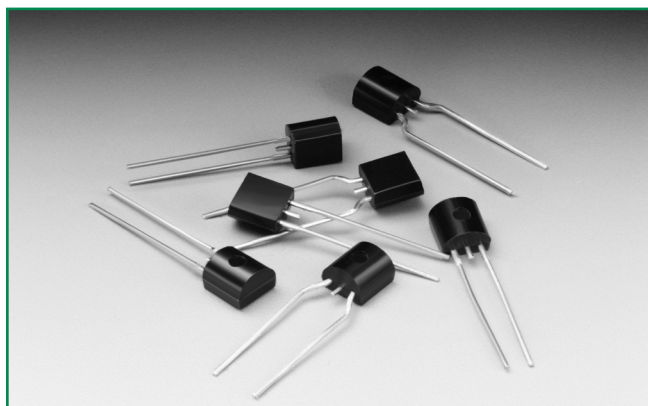

SIDACtor® Series - TO-92



Agency Approvals

Agency	Agency File Number
	E133083

Pinout Designation

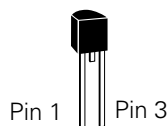

Schematic Symbol



Description

SIDACtor® Series TO-92 are designed to protect baseband equipment such as modems, line cards, CPE and DSL from damaging overvoltage transients.

The series provides a robust through-hole solution that enables equipment to comply with global regulatory standards.

Features and Benefits

- Low voltage overshoot
- Low on-state voltage
- Does not degrade surge capability after multiple surge events within limit.
- Fails short circuit when surged in excess of ratings
- Low capacitance
- 2nd level interconnect is Pb-free per IPC/ JEDEC J-STD-609A.01

Applicable Global Standards

- TIA-968-A
- TIA-968-B
- ITU K.20/21 Enhanced Level*
- ITU K.20/21 Basic Level
- GR 1089 Inter-building*
- GR 1089 Intra-building
- IEC 61000-4-5
- YD/T 1082
- YD/T 993
- YD/T 950

* A/B-rated parts require series resistance

Electrical Characteristics

Part Number	Marking	V_{DRM} @ $I_{DRM}=5\mu A$	V_S @ 100V/ μs	I_H	I_S	I_T	V_T @ $I_T=2.2$ Amps	Capacitance @ 1MHz, 2V bias	
		V min	V max	mA min	mA max	A max	V max	pF min	pF max
P0080EALxxx	P0080EA	6	25	50	800	2.2	4	25	150
P0300EALxxx	P0300EA	25	40	50	800	2.2	4	15	140
P0640EALxxx	P0640EA	58	77	150	800	2.2	4	40	60
P0720EALxxx	P0720EA	65	88	150	800	2.2	4	35	60
P0900EALxxx	P0900EA	75	98	150	800	2.2	4	35	55
P1100EALxxx	P1100EA	90	130	150	800	2.2	4	30	50
P1300EALxxx	P1300EA	120	160	150	800	2.2	4	25	45
P1500EALxxx	P1500EA	140	180	150	800	2.2	4	25	40
P1800EALxxx	P1800EA	170	220	150	800	2.2	4	25	35
P2300EALxxx	P2300EA	190	260	150	800	2.2	4	25	35
P2600EALxxx	P2600EA	220	300	150	800	2.2	4	20	35
P3100EALxxx	P3100EA	275	350	150	800	2.2	4	20	35
P3500EALxxx	P3500EA	320	400	150	800	2.2	4	20	35

Table continues on next page.

Electrical Characteristics (continued)

Part Number	Marking	V_{DRM} @ $I_{DRM}=5\mu A$	V_S @ 100V/ μs	I_H	I_S	I_T	V_T @ $I_T=2.2$ Amps	Capacitance @ 1MHz, 2V bias	
		V Min	V Max	mA Min	mA Max	A Max	V Max	pF Min	pF Max
P0080EBLxxx	P0080EB	6	25	50	800	2.2	4	25	150
P0300EBLxxx	P0300EB	25	40	50	800	2.2	4	15	140
P0640EBLxxx	P0640EB	58	77	150	800	2.2	4	40	60
P0720EBLxxx	P0720EB	65	88	150	800	2.2	4	35	75
P0900EBLxxx	P0900EB	75	98	150	800	2.2	4	35	70
P1100EBLxxx	P1100EB	90	130	150	800	2.2	4	30	70
P1300EBLxxx	P1300EB	120	160	150	800	2.2	4	25	60
P1500EBLxxx	P1500EB	140	180	150	800	2.2	4	25	55
P1800EBLxxx	P1800EB	170	220	150	800	2.2	4	25	50
xxx	P2300EB	190	260	150	800	2.2	4	25	50
P2600EBLxxx	P2600EB	220	300	150	800	2.2	4	20	45
P3100EBLxxx	P3100EB	275	350	150	800	2.2	4	20	45
P3500EBLxxx	P3500EB	320	400	150	800	2.2	4	20	40
P0080ECLxxx	P0080EC	6	25	50	800	2.2	4	35	260
P0300ECLxxx	P0300EC	25	40	50	800	2.2	4	25	250
P0640ECLxxx	P0640EC	58	77	150	800	2.2	4	55	155
P0720ECLxxx	P0720EC	65	88	150	800	2.2	4	50	150
P0900ECLxxx	P0900EC	75	98	150	800	2.2	4	45	140
P1100ECLxxx	P1100EC	90	130	150	800	2.2	4	45	115
P1300ECLxxx	P1300EC	120	160	150	800	2.2	4	40	105
P1500ECLxxx	P1500EC	140	180	150	800	2.2	4	35	95
P1800ECLxxx	P1800EC	170	220	150	800	2.2	4	35	90
P2300ECLxxx	P2300EC	190	260	150	800	2.2	4	30	80
P2600ECLxxx	P2600EC	220	300	150	800	2.2	4	30	80
P3100ECLxxx	P3100EC	275	350	150	800	2.2	4	30	70
P3500ECLxxx	P3500EC	320	400	150	800	2.2	4	25	65

Notes:
 - Absolute maximum ratings measured at $T_J = 25^\circ C$ (unless otherwise noted).
 - Devices are bi-directional (unless otherwise noted).

Notes:
 - xxx part number suffix: 'AP' = Ammo Pack, 'RP1' and 'RP2' = Reel Pack, blank = Bulk Pack

Surge Ratings

Series	I_{PP}									I_{TSM} 50/60 Hz	di/dt
	0.2x310 ¹	2x10 ¹	8x20 ¹	10x160 ¹	10x560 ¹	5x320 ¹	10x360 ¹	10x1000 ¹	5x310 ¹		
	0.5x700 ²	2x10 ²	1.2x50 ²	10x160 ²	10x560 ²	9x720 ²	10x360 ²	10x1000 ²	10x700 ²		
	A min	A min	A min	A min	A min	A min	A min	A min	A min	A min	A/ μs max
A	20	150	150	90	50	75	75	45	75	20	500
B	25	250	250	150	100	100	125	80	100	25	500
C	50	500	400	200	150	200	175	100	200	30	500

Notes:
 1 Current waveform in μs
 2 Voltage waveform in μs
 - Peak pulse current rating (I_{PP}) is repetitive and guaranteed for the life of the product that remains in thermal equilibrium.
 - I_{PP} ratings applicable over temperature range of $-40^\circ C$ to $+85^\circ C$
 - The device must initially be in thermal equilibrium with $-40^\circ C \leq T_J \leq +150^\circ C$

Thermal Considerations

Package	Symbol	Parameter	Value	Unit
TO-92 	T_J	Operating Junction Temperature Range	-40 to +150	$^\circ C$
	T_S	Storage Temperature Range	-65 to +150	$^\circ C$
	$R_{\theta JA}$	Thermal Resistance: Junction to Ambient	90	$^\circ C/W$

V-I Characteristics

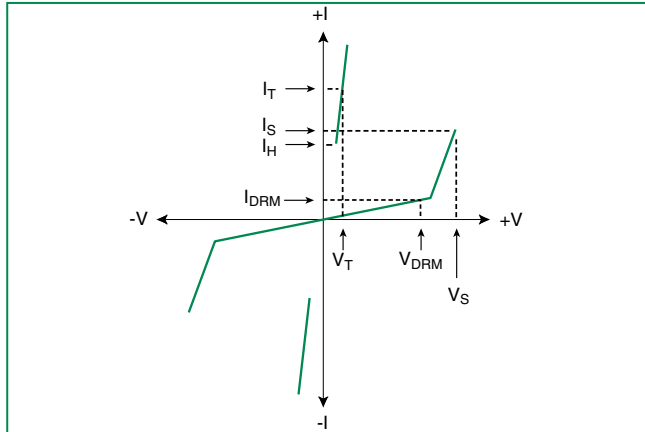

$t_r \times t_d$ Pulse Waveform

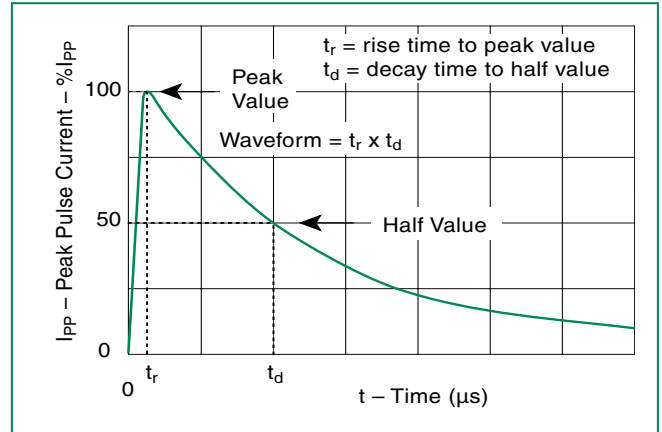

Normalized V_S Change vs. Junction Temperature

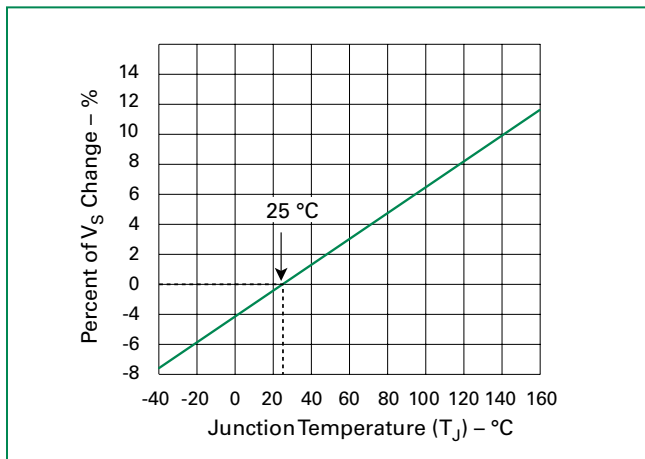

Normalized DC Holding Current vs. Case Temperature

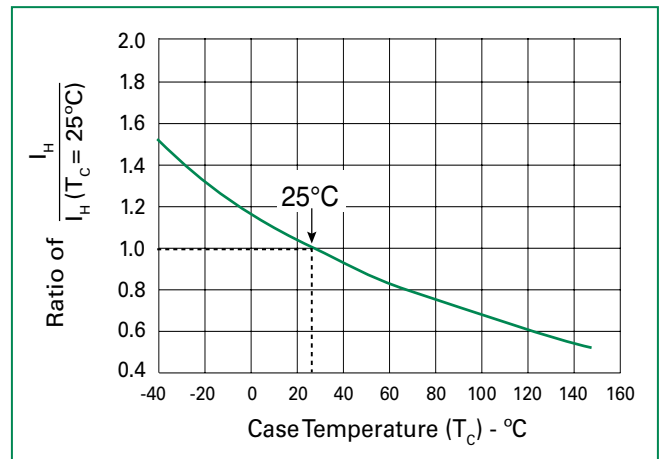

Soldering Parameters

Reflow Condition		Pb-Free assembly (see Fig. 1)
Pre Heat	-Temperature Min ($T_{s(min)}$)	+150°C
	-Temperature Max ($T_{s(max)}$)	+200°C
	-Time (Min to Max) (t_s)	60-180 secs.
Average ramp up rate (Liquidus Temp (T_L) to peak)		3°C/sec. Max.
$T_{s(max)}$ to T_L - Ramp-up Rate		3°C/sec. Max.
Reflow	-Temperature (T_L) (Liquidus)	+217°C
	-Temperature (t_L)	60-150 secs.
Peak Temp (T_p)		+260(+0/-5)°C
Time within 5°C of actual Peak Temp (t_p)		30 secs. Max.
Ramp-down Rate		6°C/sec. Max.
Time 25°C to Peak Temp (T_p)		8 min. Max.
Do not exceed		+260°C

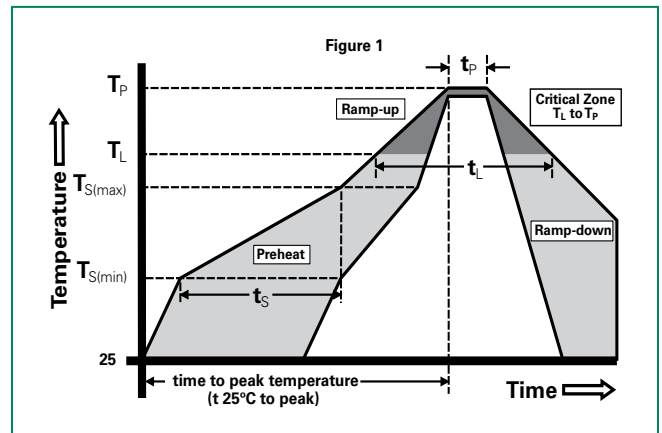

Physical Specifications

Lead Material	Copper Alloy
Terminal Finish	100% Matte-Tin Plated
Body Material	UL recognized epoxy meeting flammability classification 94V-0

Environmental Specifications

High Temp Voltage Blocking	80% Rated V_{DRM} (V_{AC} Peak) +125°C or +150°C, 504 or 1008 hrs. MIL-STD-750 (Method 1040) JEDEC, JESD22-A-101
Temp Cycling	-65°C to +150°C, 15 min. dwell, 10 up to 100 cycles. MIL-STD-750 (Method 1051) EIA/JEDEC, JESD22-A104
Biased Temp & Humidity	52 V_{DC} (+85°C) 85%RH, 504 up to 1008 hrs. EIA/JEDEC, JESD22-A-101
High Temp Storage	+150°C 1008 hrs. MIL-STD-750 (Method 1031) JEDEC, JESD22-A-101
Low Temp Storage	-65°C, 1008 hrs.
Thermal Shock	0°C to +100°C, 5 min. dwell, 10 sec. transfer, 10 cycles. MIL-STD-750 (Method 1056) JEDEC, JESD22-A-106
Autoclave (Pressure Cooker Test)	+121°C, 100%RH, 2atm, 24 up to 168 hrs. EIA/JEDEC, JESD22-A-102
Resistance to Solder Heat	+260°C, 30 secs. MIL-STD-750 (Method 2031)
Moisture Sensitivity Level	85%RH, +85°C, 168 hrs., 3 reflow cycles (+260°C Peak). JEDEC-J-STD-020, Level 1

Part Numbering

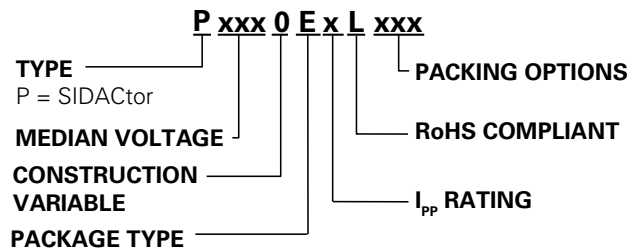

Part Marking

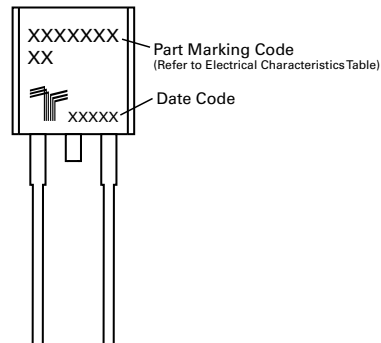

Packing Options

Package Type	Description	Packing Options Quantity	Added Suffix	Lead Spacing	Industry Standard
E	TO-92 Tape and Reel Pack	2000	RP1	0.1 inch (2.54mm)	EIA-481-D
	TO-92 Ammo Pack		RP2	0.2 inch (5.08mm)	
	TO-92 Bulk Pack		AP		EIA-468-B
			N/A		N/A

Additional Information



Datasheet



Resources



Samples

Dimensions — TO-92

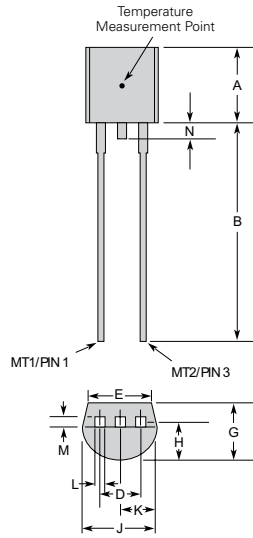

	Inches		Millimeters	
	Min	Max	Min	Max
A	0.176	0.196	4.47	4.98
B	0.500		12.70	
D	0.095	0.105	2.41	2.67
E	0.150		3.81	
G	0.135	0.145	3.43	3.68
H	0.088	0.096	2.23	2.44
J	0.176	0.186	4.47	4.73
K	0.088	0.096	2.23	2.44
L	0.013	0.019	0.33	0.48
M	0.013	0.017	0.33	0.43
N		0.60		1.52

All leads are insulated from case. Case is electrically non-conductive. (Rated at 1600 V_{(AC) RMS} for one minute from leads to case over the operating temperature range.)

Mold flash shall not exceed 0.13 mm per side.

The TO-92 is designed to meet mechanical standards as set forth in JEDEC publication number 95.

Ammo Pack Specification — TO-92

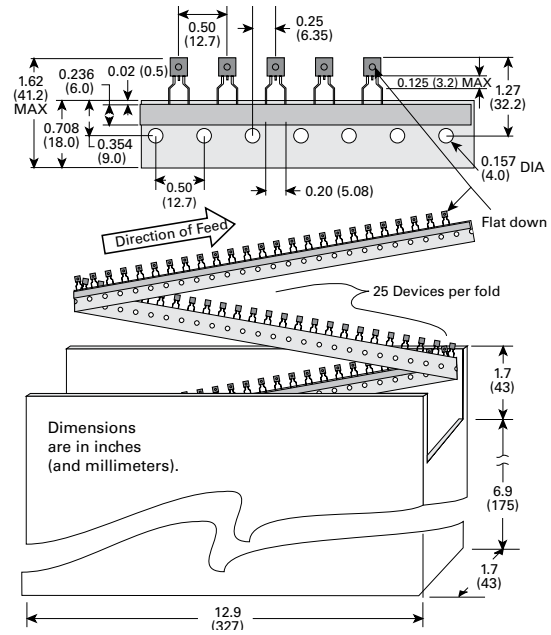

Tape and Reel Specification — TO-92

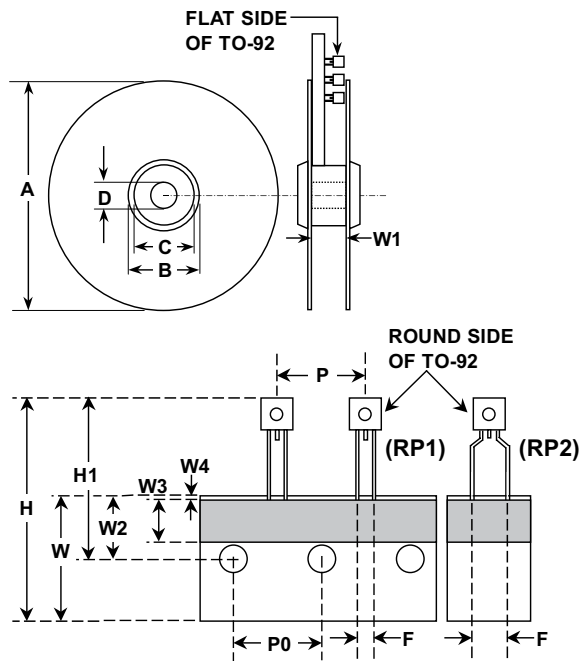

Dimensions	Inches		Millimeters	
	Min	Max	Min	Max
A	N/A	14.173	N/A	360.0
B	4.016	N/A	102.0	N/A
C	3.386	N/A	86.0	N/A
D	0.795	N/A	20.2	N/A
W1	1.181	1.968	30.0	50.0
P	0.496	0.504	12.60	12.80
P0	0.498	0.502	12.65	12.75
F(for RP1)	0.090	0.110	2.29	2.80
F(for RP2)	0.182	0.244	4.63	6.19
H	N/A	1.673	N/A	42.50
H1	N/A	1.270	N/A	32.26
W	0.674	0.763	17.12	19.38
W2	0.354	0.370	8.25	9.75
W3	0.236	N/A	6.00	N/A
W4	0.020	N/A	0.50	N/A

Disclaimer Notice - Information furnished is believed to be accurate and reliable. However, users should independently evaluate the suitability of and test each product selected for their own applications. Littelfuse products are not designed for, and may not be used in, all applications. Read complete Disclaimer Notice at www.littelfuse.com/disclaimer-electronics.