

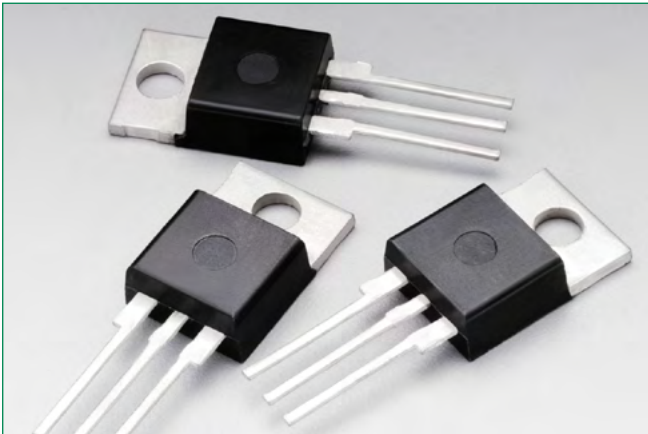

BTB12-600CW3G, BTB12-800CW3G

Surface Mount – 800V



Description

The BTB12 is designed for high performance full-wave AC control applications where high noise immunity and high commutating di/dt are required.

Features

- Blocking Voltage to 800 V
- On-State Current Rating of 12 Amperes RMS at 25°C
- Uniform Gate Trigger Currents in Three Quadrants
- High Immunity to dV/dt – 1500 V/μs minimum at 125°C
- Minimizes Snubber Networks for Protection
- Industry Standard TO-220AB Package
- High Commutating di/dt – 3.0. A/ms minimum at 125°C
- These are Pb-Free Devices

Additional Information



Resources



Accessories



Samples

Functional Diagram

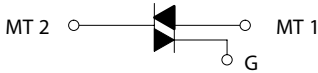

Pin Out

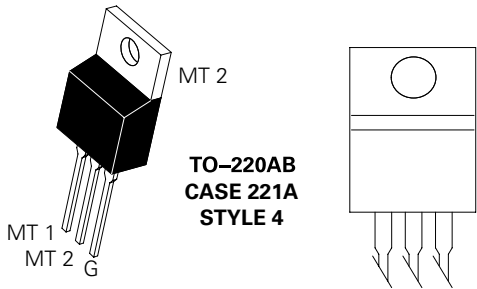

BTB12-600CW3G, BTB12-800CW3G

Surface Mount – 800V

Maximum Ratings ($T_J = 25^\circ\text{C}$ unless otherwise noted)

Rating	Symbol	Value	Unit
Peak Repetitive Off-State Voltage (Note 1) (Gate Open, Sine Wave 50 to 60 Hz, $T_J = -40^\circ$ to 125°C)	V_{DRM} V_{RRM}	600 800	V
On-State RMS Current (Full Cycle Sine Wave, 60 Hz, $T_C = 80^\circ\text{C}$)	$I_{T(RMS)}$	12	A
Peak Non-Repetitive Surge Current (One Full Cycle Sine Wave, 60 Hz, $T_C = 25^\circ\text{C}$)	I_{TSM}	120	A
Circuit Fusing Consideration ($t = 10$ ms)	I^2t	78	A ² sec
Non-Repetitive Surge Peak Off-State Voltage ($T_J = 25^\circ\text{C}$, $t = 10$ ms)	V_{DSM}/V_{RSM}	$V_{DSM}/V_{RSM} + 100$	V
Peak Gate Current ($T_J = 125^\circ\text{C}$, $t = 20$ ms)	I_{GM}	4.0	W
Peak Gate Power (Pulse Width ≤ 1.0 μs , $T_C = 80^\circ\text{C}$)	P_{GM}	20	W
Average Gate Power ($T_J = 125^\circ\text{C}$)	$P_{G(AV)}$	1.0	W
Operating Junction Temperature Range	T_J	-40 to +125	$^\circ\text{C}$
Storage Temperature Range	T_{stg}	-40 to +150	$^\circ\text{C}$

Stresses exceeding Maximum Ratings may damage the device. Maximum Ratings are stress ratings only. Functional operation above the Recommended Operating Conditions is not implied. Extended exposure to stresses above the Recommended Operating Conditions may affect device reliability.

1. V_{DRM} and V_{RRM} for all types can be applied on a continuous basis. Ratings apply for zero or negative gate voltage; however, positive gate voltage shall not be applied concurrent with negative potential on the anode. Blocking voltages shall not be tested with a constant current source such that the voltage ratings of the devices are exceeded.

Thermal Characteristics

Rating	Symbol	Value	Unit	
Thermal Resistance	Junction-to-Case (AC) Junction-to-Ambient	$R_{\theta JC}$ $R_{\theta JA}$	2.3 60	$^\circ\text{C}/\text{W}$
Maximum Lead Temperature for Soldering Purposes, 1/8" from case for 10 seconds	T_L	260	$^\circ\text{C}$	

Electrical Characteristics - OFF ($T_J = 25^\circ\text{C}$ unless otherwise noted ; Electricals apply in both directions)

Characteristic	Symbol	Min	Typ	Max	Unit
Peak Repetitive Blocking Current ($V_D = V_{DRM} = V_{RRM}$; Gate Open)	I_{DRM} I_{RRM}	-	-	0.005	mA
		-	-	1.0	

Electrical Characteristics - ON ($T_J = 25^\circ\text{C}$ unless otherwise noted; Electricals apply in both directions)

Characteristic	Symbol	Min	Typ	Max	Unit
Forward On-State Voltage (Note 2) ($I_{TM} = \pm 17$ A Peak)	V_{TM}	-	-	1.55	V
Gate Trigger Current (Continuous dc) ($V_D = 12$ V, $R_L = 30$ Ω)	MT2(+), G(+)	2.0	-	35	mA
	MT2(+), G(-)	2.0	-	35	
	MT2(-), G(-)	2.0	-	35	
Holding Current ($V_D = 12$ V, Gate Open, Initiating Current = ± 100 mA)	I_H	-	-	45	mA
Latching Current ($V_D = 12$ V, $I_G = 42$ mA)	MT2(+), G(+)	-	-	50	mA
	MT2(+), G(-)	-	-	80	
	MT2(-), G(-)	-	-	50	
Gate Trigger Voltage ($V_D = 12$ V, $R_L = 30$ Ω)	MT2(+), G(+)	0.5	-	1.7	V
	MT2(+), G(-)	0.5	-	1.1	
	MT2(-), G(-)	0.5	-	1.1	
Gate Non-Trigger Voltage ($T_J = 125^\circ\text{C}$)	MT2(+), G(+)	0.2	-	-	V
	MT2(+), G(-)	0.2	-	-	
	MT2(-), G(-)	0.2	-	-	

2. Indicates Pulse Test: Pulse Width ≤ 2.0 ms, Duty Cycle $\leq 2\%$.

BTB12-600CW3G, BTB12-800CW3G

Surface Mount – 800V

Dynamic Characteristics

Characteristic	Symbol	Min	Typ	Max	Unit
Rate of Change of Commutating Current, See Figure 10. (Gate Open, $T_j = 125^\circ\text{C}$, No Snubber)	$(di/dt)_c$	3.0	–	–	A/ms
Critical Rate of Rise of On-State Current ($T_j = 125^\circ\text{C}$, $f = 120\text{ Hz}$, $I_G = 2 \times I_{GT}$, $tr \leq 100\text{ ns}$)	di/dt	–	–	50	A/ μs
Critical Rate of Rise of Off-State Voltage ($V_D = 0.66 \times V_{DRM}$, Exponential Waveform, Gate Open, $T_j = 125^\circ\text{C}$)	dV/dt	1500	–	–	V/ μs

Voltage Current Characteristic of SCR

Symbol	Parameter
V_{DRM}	Peak Repetitive Forward Off State Voltage
I_{DRM}	Peak Forward Blocking Current
V_{RRM}	Peak Repetitive Reverse Off State Voltage
I_{RRM}	Peak Reverse Blocking Current
V_{TM}	Maximum On State Voltage
I_H	Holding Current

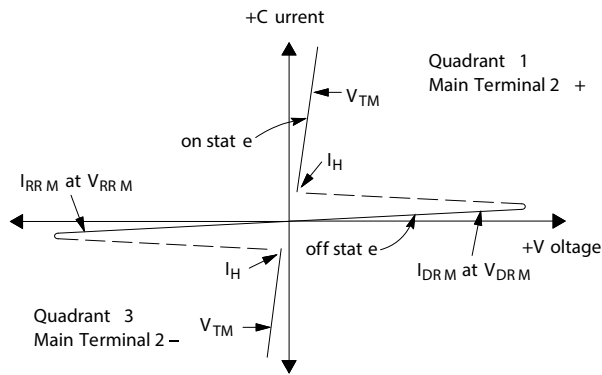

Quadrant Definitions for a Triac

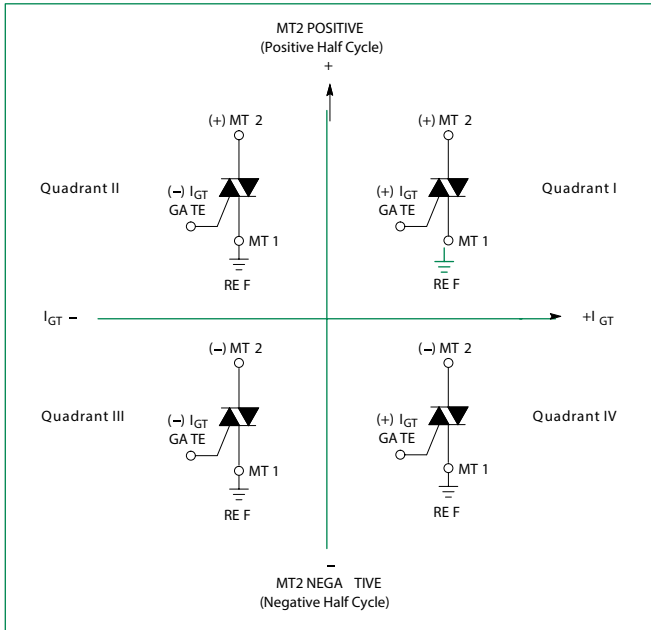

All polarities are referenced to MT1.
With in-phase signals (using standard AC lines) quadrants I and III are used

BTB12-600CW3G, BTB12-800CW3G

Surface Mount – 800V

Figure 1. RMS Current Derating

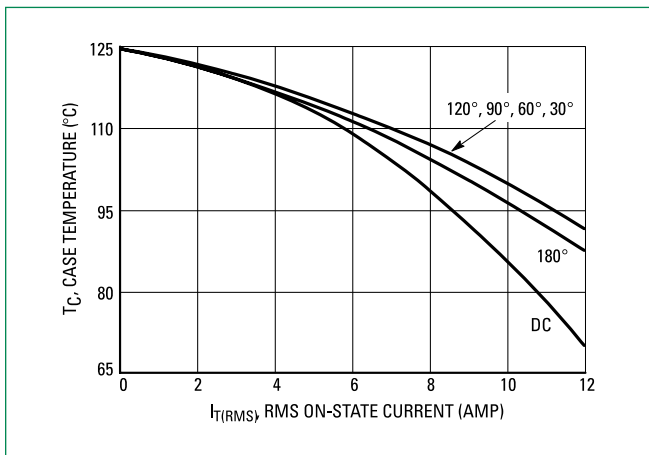

Figure 2. On-State Power Dissipation

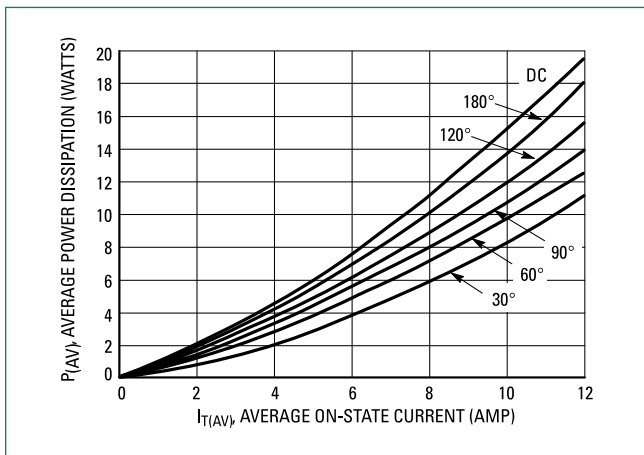

Figure 3. On-State Characteristics

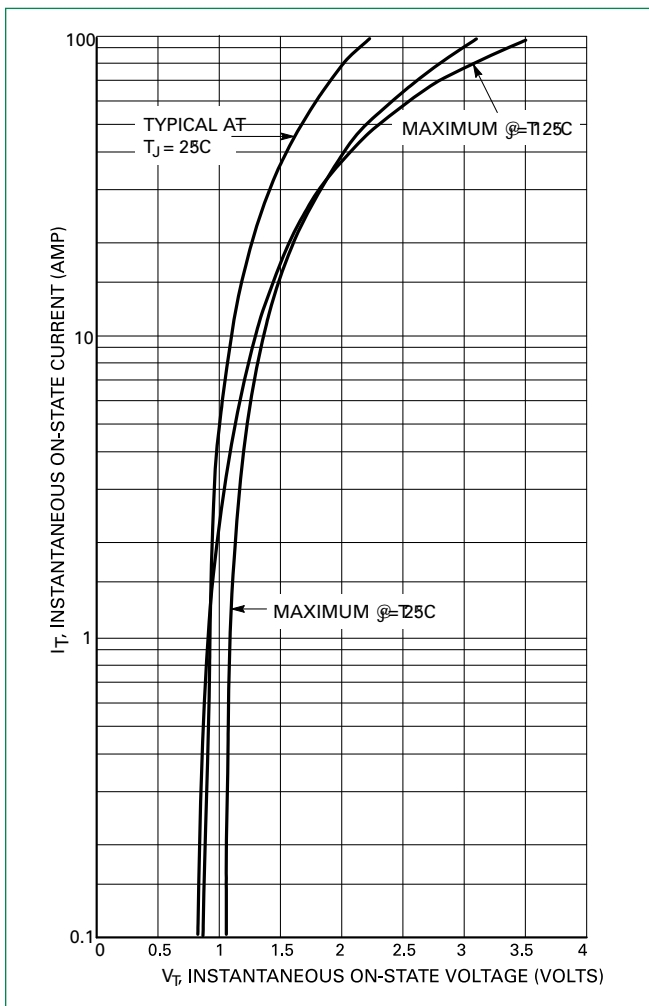

Figure 4. Thermal Response

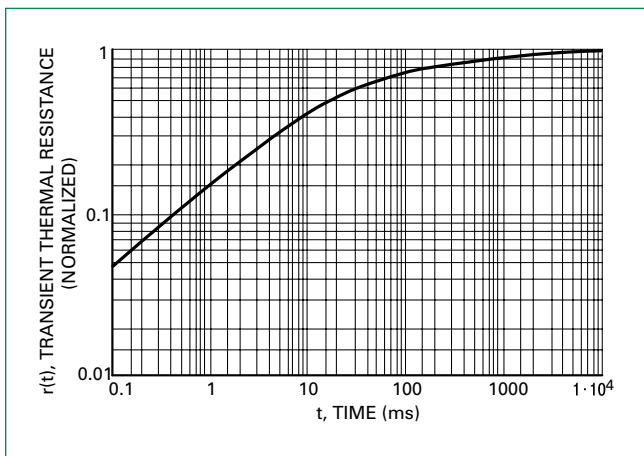
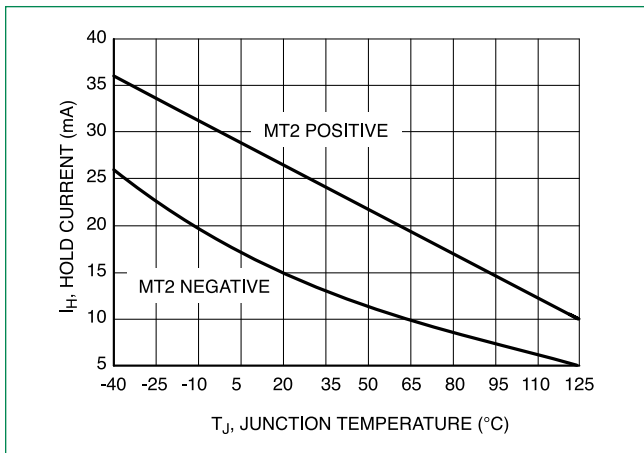

Figure 5. Typical Hold Current Variation



BTB12-600CW3G, BTB12-800CW3G

Surface Mount – 800V

Figure 6. Typical Gate Trigger Current Variation

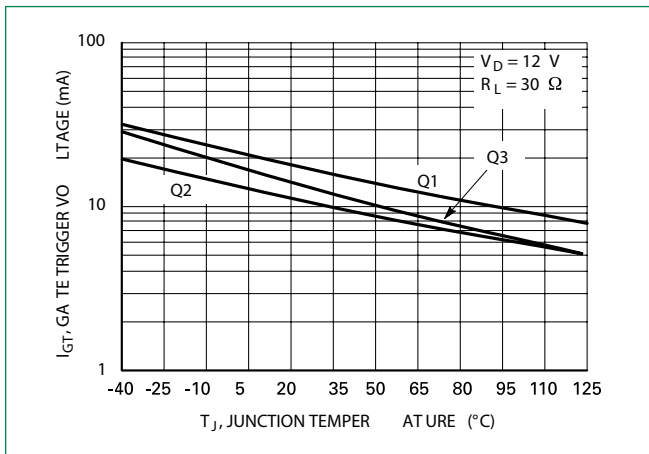

Figure 7. Typical Gate Trigger Voltage Variation

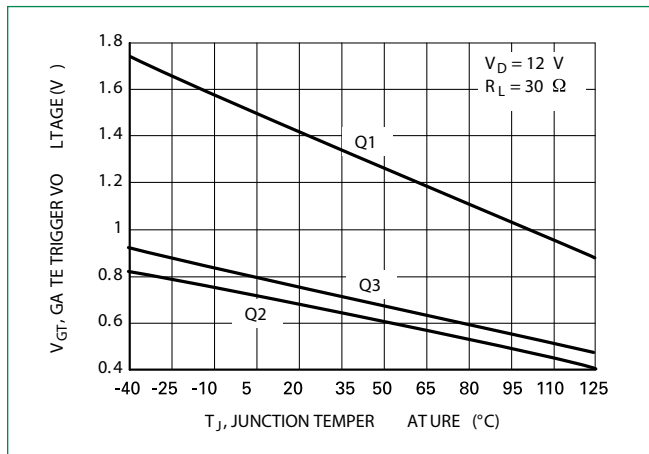

Figure 8. Critical Rate of Rise of Off-State Voltage (Exponential Waveform)

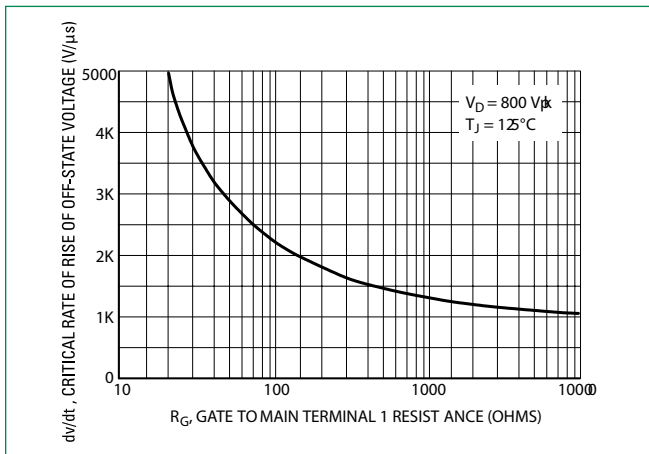
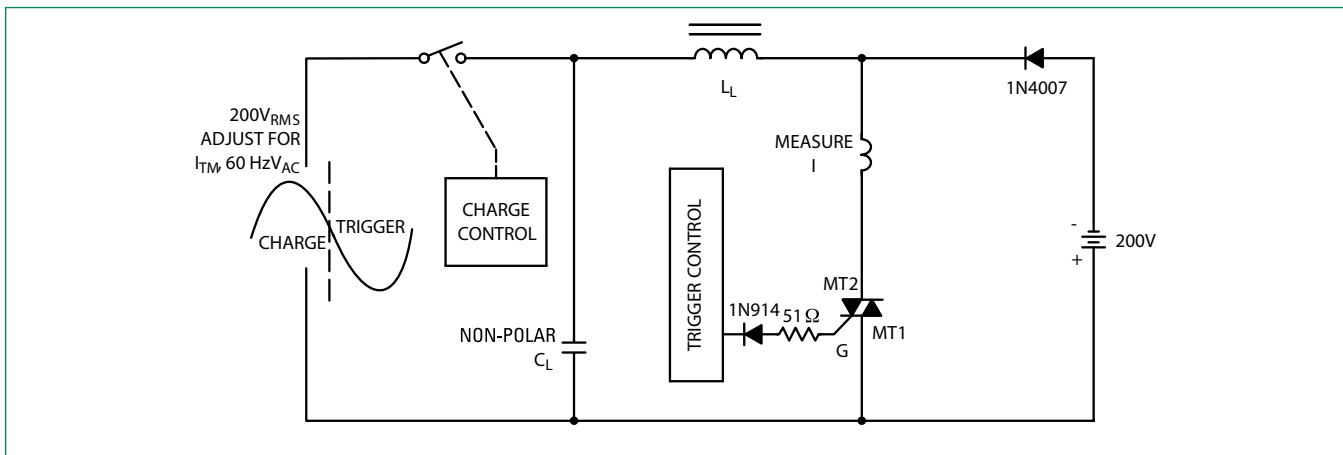

Figure 9. Simplified Test Circuit to Measure the Critical Rate of Rise of Commutating Current (di/dt)



Note: Component values are for verification of rated $(di/dt)_c$. See AN1048 for additional information

BTB12-600CW3G, BTB12-800CW3G

Surface Mount – 800V

Dimensions

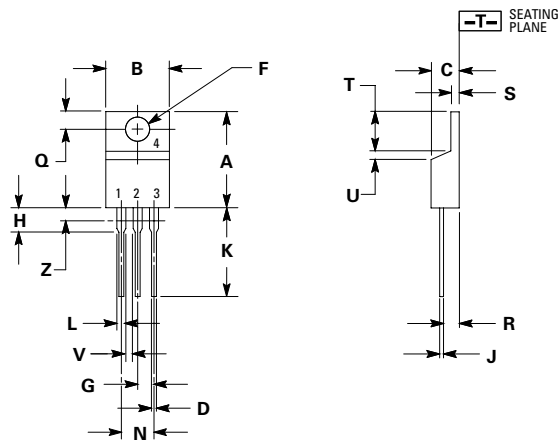

Dim	Inches		Millimeters	
	Min	Max	Min	Max
A	0.590	0.620	14.99	15.75
B	0.380	0.420	9.65	10.67
C	0.178	0.188	4.52	4.78
D	0.025	0.035	0.64	0.89
F	0.142	0.147	3.61	3.73
G	0.095	0.105	2.41	2.67
H	0.110	0.130	2.79	3.30
J	0.018	0.024	0.46	0.61
K	0.540	0.575	13.72	14.61
L	0.060	0.075	1.52	1.91
N	0.195	0.205	4.95	5.21
Q	0.105	0.115	2.67	2.92
R	0.085	0.095	2.16	2.41
S	0.045	0.060	1.14	1.52
T	0.235	0.255	5.97	6.47
U	0.000	0.050	0.00	1.27
V	0.045	—	1.15	—
Z	—	0.080	—	2.04

1. Dimensioning and tolerancing per ansi y14.5m, 1982.
2. Controlling dimension: inch.
3. Dimension z defines a zone where all body and lead irregularities are allowed.

Part Marking System

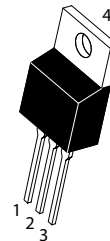

**TO-220AB
CASE 221A
STYLE 12**

x =6 or 8
Y =Year
M =Month
A =Assembly Site
XX =Lot Serial Code
G =Pb-Free Package

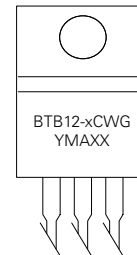

Pin Assignment	
1	Main Terminal 1
2	Main Terminal 2
3	Gate
4	Main Terminal 2

Ordering Information

Device	Package	Shipping
BTB12-600CW3G	TO-220AB (Pb-Free)	1000 Units / Box
BTB12-800CW3G	TO-220AB (Pb-Free)	1000 Units / Box

Disclaimer Notice - Information furnished is believed to be accurate and reliable. However, users should independently evaluate the suitability of and test each product selected for their own applications. Littelfuse products are not designed for, and may not be used in, all applications. Read complete Disclaimer Notice at <http://www.littelfuse.com/disclaimer-electronics>.