

C106 Series

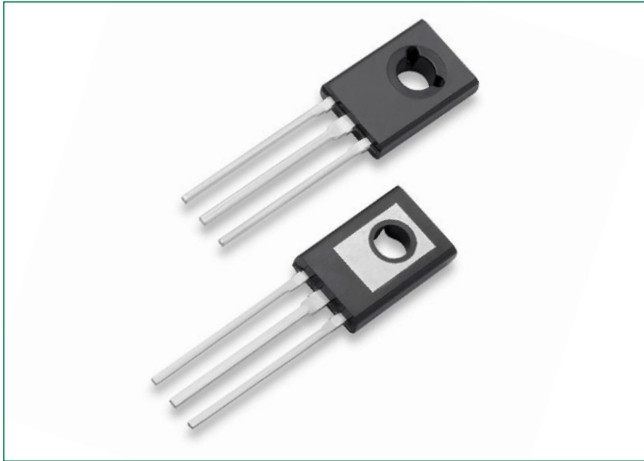

Description

Glassivated PNP devices designed for high volume consumer applications such as temperature, light, and speed control; process and remote control, and warning systems where reliability of operation is important.

Features

- Glassivated Surface for Reliability and Uniformity
- Power Rated at Economical Prices
- Practical Level Triggering and Holding Characteristics
- Flat, Rugged, Thermopad Construction for Low Thermal Resistance, High Heat Dissipation and Durability
- Sensitive Gate Triggering
- These are Pb-Free Devices

Pin Out

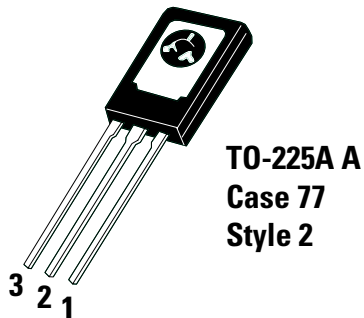

Functional Diagram



Additional Information



Datasheet



Resources



Samples

Maximum Ratings ($T_J = 25^\circ\text{C}$ unless otherwise noted)

Rating	Symbol	Value	Unit
Peak Repetitive Off-State Voltage (Sine Wave, 50–60 Hz, RGK = 1 K, TC = -40° to 110°C)	V_{DRM}^* V_{RRM}	200 400 600	V
On-State RMS Current (180° Conduction Angles, TC = 80°C)	I_T (RMS)	4.0	A
Average On-State Current (180° Conduction Angles, $T_c = 80^\circ\text{C}$)	$I_{T(AV)}$	2.55	A
Peak Non-Repetitive Surge Current (1/2 Cycle, Sine Wave, 60 Hz, $T_J = +25^\circ\text{C}$)	I_{TSM}	20	A
Circuit Fusing Considerations ($t = 8.3$ ms)	I^2t	1.65	A2s
Forward Peak Gate Current (Pulse Width 1.0 sec, TC = 80°C)	I_{GM}	0.2	A
Forward Peak Gate Power (Pulse Width ≤ 1.0 μsec , $T_c = 80^\circ\text{C}$)	P_{GM}	0.5	W
Forward Average Gate Power (Pulse Width ≤ 1.0 μsec , $T_c = 80^\circ\text{C}$)	$P_{G(AV)}$	0.1	W
Operating Junction Temperature Range	T_J	-40 to +110	°C
Storage Temperature Range	T_{stg}	-40 to +150	°C
Mounting Torque (Note 2)	–	6.0	in. lb.

Stresses exceeding Maximum Ratings may damage the device. Maximum Ratings are stress ratings only. Functional operation above the Recommended Operating Conditions is not implied. Extended exposure to stresses above the Recommended Operating Conditions may affect device reliability.

- V_{DRM} and V_{RRM} for all types can be applied on a continuous basis. Ratings apply for zero or negative gate voltage; however, positive gate voltage shall not be applied concurrent with negative potential on the anode. Blocking voltages shall not be tested with a constant current source such that the voltage ratings of the devices are exceeded.
- Torque rating applies with use of torque washer (Shakeproof WD19523 or equivalent). Mounting Torque in excess of 6 in. lb. does not appreciably lower case-to-sink thermal resistance. Main terminal 2 and heat-sink contact pad are common.

Thermal Characteristics

Rating	Symbol	Value	Unit
Thermal Resistance, Junction-to-Case (AC) Junction-to-Ambient	$R_{\theta JC}$ $R_{\theta JA}$	3.0 75	°C/W
Maximum Lead Temperature for Soldering Purposes, 1/8" from case for 10 seconds	T_L	260	°C

Electrical Characteristics - OFF ($T_J = 25^\circ\text{C}$ unless otherwise noted)

Characteristic	Symbol	Min	Typ	Max	Unit	
Peak Repetitive Forward or Reverse Blocking Current ($V_{AK} = \text{Rated } V_{DRM} \text{ or } V_{RRM}$, $R_{GK} = 1 \text{ k}\Omega$)	I_{DRM}^* I_{RRM}	$T_J = 25^\circ\text{C}$	–	–	10	μA
		$T_J = 110^\circ\text{C}$	–	–	100	μA

Electrical Characteristics - ON ($T_J = 25^\circ\text{C}$ unless otherwise noted)

Characteristic	Symbol	Min	Typ	Max	Unit	
Peak Forward On-State Voltage (Note 3) ($I_{TM} = 4$ A)	V_{TM}	–	–	2.2	V	
Gate Trigger Current (Continuous dc) ($V_D = 12$ V, $R_L = 100 \Omega$, All Quadrants)	I_{GT}	$T_J = 25^\circ\text{C}$	–	15	200	μA
		$T_J = -40^\circ\text{C}$	–	35	500	μA
Peak Reverse Gate Voltage ($I_{GR} = 10 \mu\text{A}$)	V_{GRM}	–	–	6.0	V	
Gate Trigger Voltage (Continuous dc) ($V_D = 12$ Vdc, $R_L = 100 \Omega$, $T_c = 25^\circ\text{C}$)	V_{GT}	$T_J = 25^\circ\text{C}$	0.4	0.60	0.8	V
		$T_J = -40^\circ\text{C}$	0.5	0.75	1.0	V
Gate Non-Trigger Voltage (Continuous dc) (Note 4) ($V_{AK} = 12$ V, $R_L = 100 \Omega$, ($V_{AK} = 12$ V, $R_L = 100 \Omega$, $T_J = 110^\circ\text{C}$), $T_J = 110^\circ\text{C}$)	V_{GD}	0.2	–	–	V	
Latching Current ($V_{AK} = 12$ V, $I_G = 20$ mA, $R_{GK} = 1 \text{ k}\Omega$)	I_L	$T_J = 25^\circ\text{C}$	–	0.20	5.0	mA
		$T_J = -40^\circ\text{C}$	–	0.35	7.0	mA
Holding Current ($V_D = 12$ Vdc) (Initiating Current = 20 mA, $R_{GK} = 1 \text{ k}\Omega$)	I_H	$T_J = 25^\circ\text{C}$	–	0.19	3.0	mA
		$T_J = -40^\circ\text{C}$	–	0.33	6.0	mA
		$T_J = +110^\circ\text{C}$	–	0.07	2.0	mA

Dynamic Characteristics

Characteristic	Symbol	Min	Typ	Max	Unit
Critical Rate-of-Rise of Off State Voltage (V_{AK} = Rated V_{DRM} , Exponential Waveform, $R_{GK} = 1k\Omega, T_J = 110^\circ C$)	dv/dt	-	8.0	-	V/ μs

- 3. Pulse Test: Pulse Width ≤ 2.0 ms, Duty Cycle $\leq 2\%$.
- 4. R_{GK} is not included in measurement.

Voltage Current Characteristic of SCR

Symbol	Parameter
V_{DRM}	Peak Repetitive Forward Off State Voltage
I_{DRM}	Peak Forward Blocking Current
V_{RRM}	Peak Repetitive Reverse Off State Voltage
I_{RRM}	Peak Reverse Blocking Current
V_{TM}	Maximum On State Voltage
I_H	Holding Current

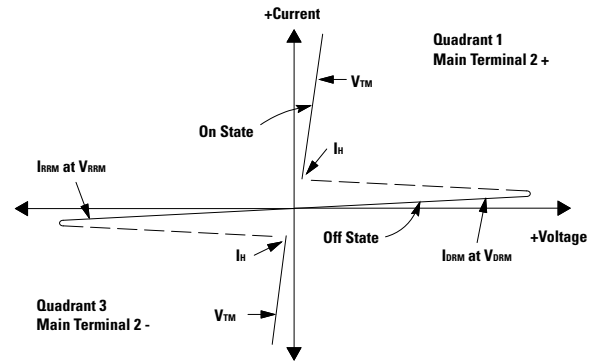

Figure 1. Average Current Derating

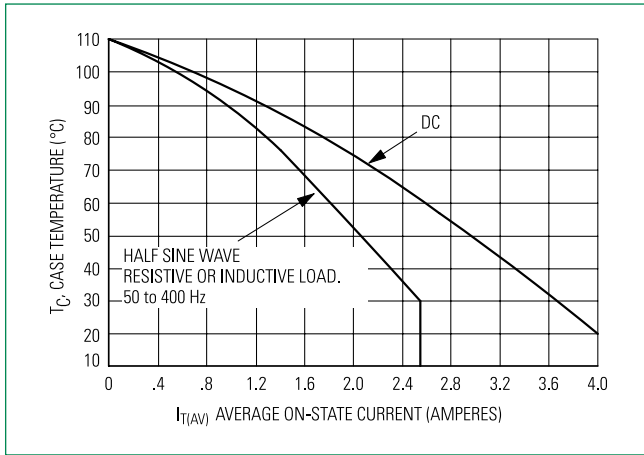

Figure 2. Maximum On-State Power Dissipation

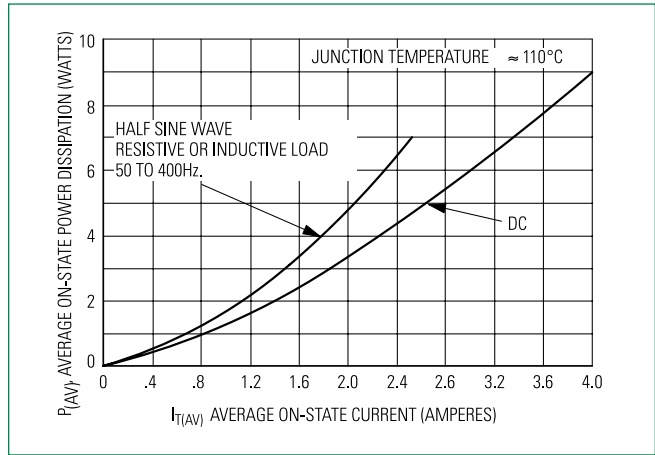

Figure 3. Typical Gate Trigger Current vs. Junction Temp

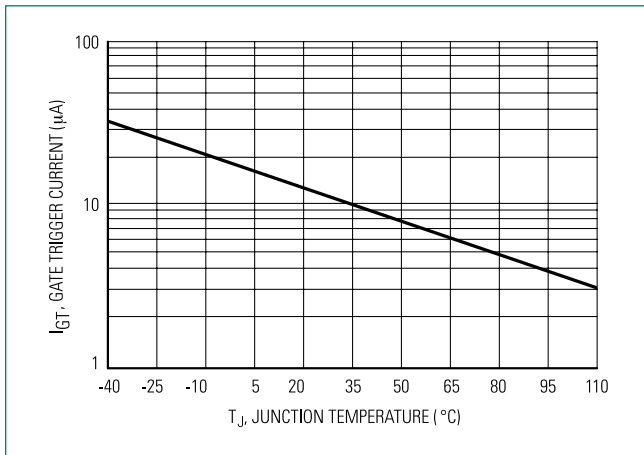

Figure 4. Typical Holding Current vs. Junction Temp

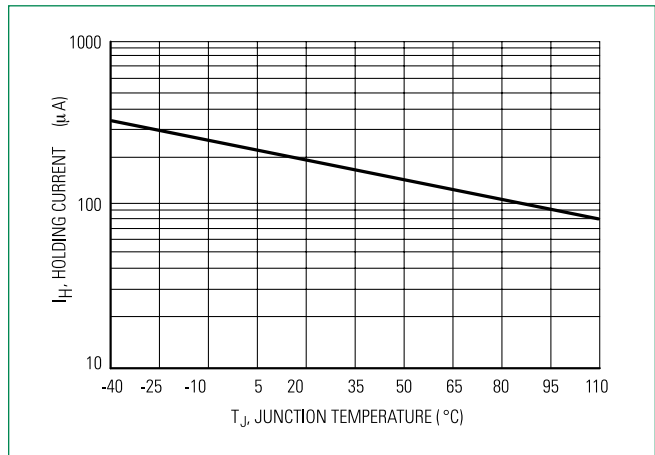

Figure 5. Typical Gate Trigger Voltage vs. Junction Temp

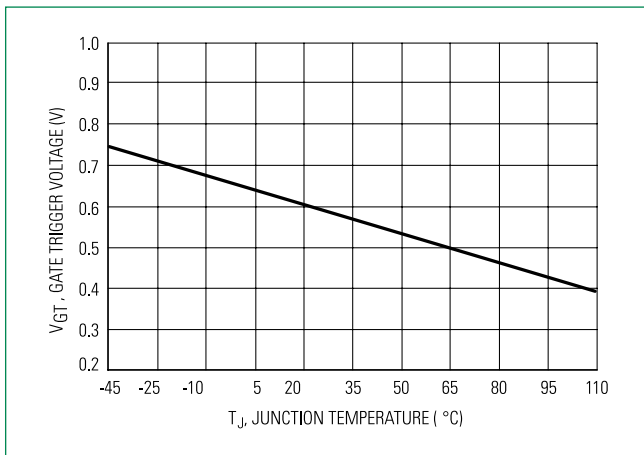
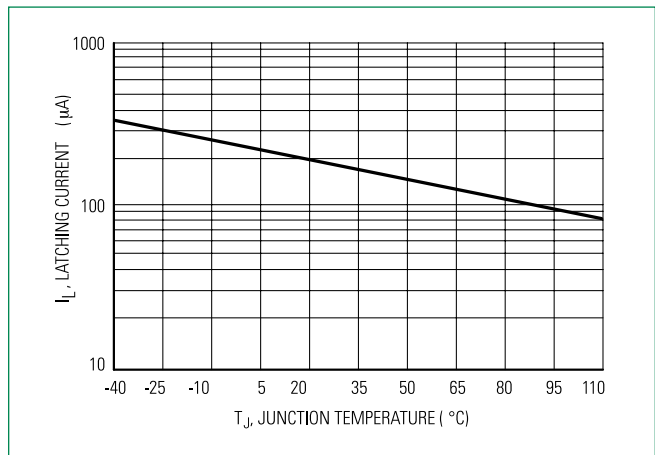
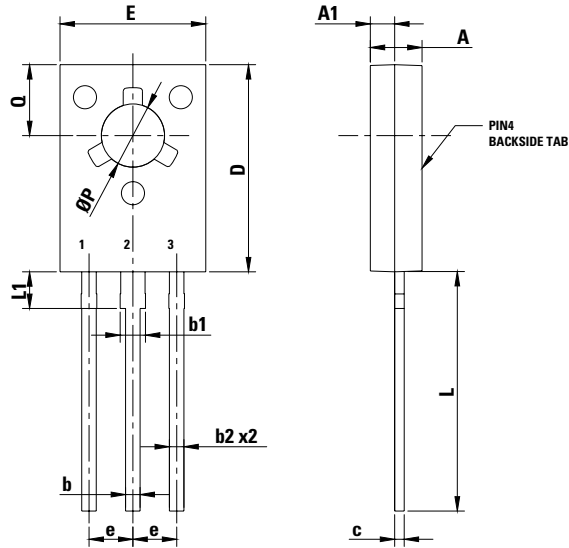

Figure 5. Typical Latching Current vs. Junction Temp



Dimensions



Part Marking System

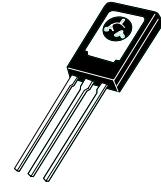

TO-225A A
Case 07 7
Style 2

- 1. Cathode
- 2. Anode
- 3. Gate

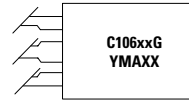

- Y =Year
- M =Month
- A =Assembly Site
- XX =Lot Serial Code
- C106xx =Device Code
- xx =B, D, D1, M, M1
- G =Pb-Free Package

Dim	Inches		Millimeters	
	Min	Max	Min	Max
A	0.102	0.110	2.60	2.80
A1	0.047	0.055	1.20	1.40
b	0.028	0.034	0.70	0.86
b2	0.028	0.034	0.70	0.86
c	0.019	0.022	0.49	0.57
D	0.417	0.449	10.60	11.40
E	0.291	0.323	7.40	8.20
e	0.090 TYP		2.29 TYP	
L	0.551	0.630	14.00	16.00
L1	0.091	0.106	2.30	2.70
P	0.118	0.134	3.00	3.40
Q	0.142	0.157	3.60	4.00
b1	0.047	0.055	1.2	1.4

1. DIMENSIONING AND TOLERANCING PER ANSI Y14.5M, 1982.
2. CONTROLLING DIMENSION: INCH.
3. 077-01 THRU -08 OBSOLETE, NEW STANDARD 077-09.

Pin Assignment	
1	Cathode
2	Anode
3	Gate

Ordering Information

Device	Package	Shipping
C106BG	TO225AA (Pb-Free)	2500 Units/Box
C106DG		
C106D1G*		
C106MG		
C106M1G*		
C106MTG		60 Units/Tube 1920 Units/Box

*D1 signifies European equivalent for D suffix and M1 signifies European equivalent for M suffix.