

# CLA30MT1200NPZ

1200 V, 15 A High Efficiency Thyristor

Three Quadrants Operation: QI–QIII, 1 ~ TRIAC

RoHS

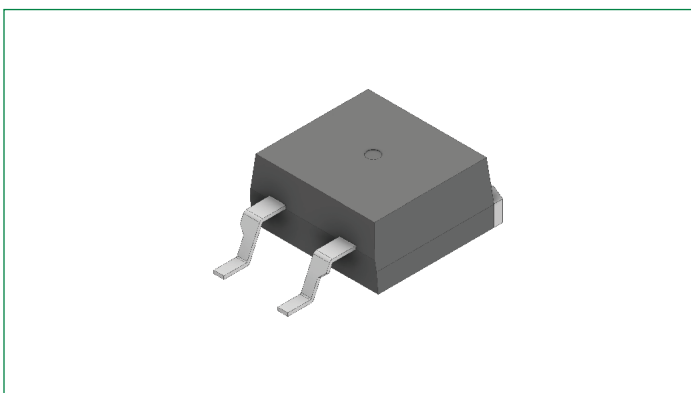

## Features:

- TRIAC for line frequency
- Three quadrants operation: QI–QIII
- Planar passivated chip
- Long-term stability of blocking currents and voltages

## Applications:

- Line rectifying 50/60 Hz
- Soft start AC motor control
- Lighting and temperature control
- DC motor control
- Power converter
- AC power control

## Package:

- Epoxy meets UL 94V-0
- Industry standard outline
- High creepage distance between terminals
- RoHS compliant

## Product Summary

Characteristic	Value	Unit
$V_{RRM}$	1200	V
$I_{TAV}$	15	A
$V_T$	1.35	V

## Pinout Diagram TO-263 (D<sup>2</sup>PAK-HV)

Backside: anode/cathode  
4 (Tab)

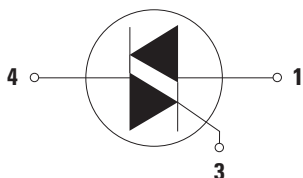
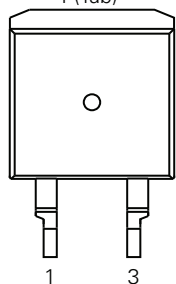

1: T1; 3: Gate; 4: T2

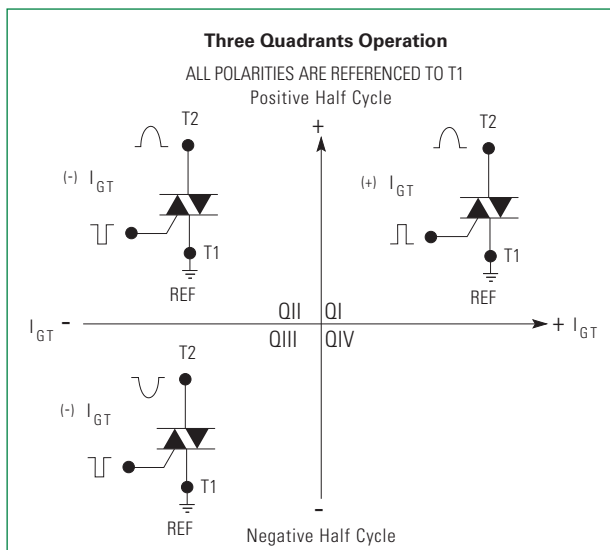

## Maximum Ratings

Symbol	Characteristics	Conditions	Value	Units	
$I_{T(RMS)}$	RMS Forward Current per Phase	180° Sine; $T_C = 120\text{ °C}$ ; $T_{vj} = 150\text{ °C}$	33	A	
$I_{TAV}$	Average Forward Current		15		
$I_{R/D}$	Reverse Current, Drain Current	$T_{vj} = 25\text{ °C}$ ; $V_{R/D} = 1200\text{ V}$	10	$\mu\text{A}$	
		$T_{vj} = 125\text{ °C}$ ; $V_{R/D} = 1200\text{ V}$	1.5	mA	
$I_{TSM}$	Maximum Forward Surge Current	$T_{vj} = 45\text{ °C}$	t = 10 ms, 50 Hz sine, $V_R = 0\text{ V}$	170	A
			t = 8.3 ms, 60 Hz sine, $V_R = 0\text{ V}$	185	
		$T_{vj} = 150\text{ °C}$	t = 10 ms, 50 Hz sine, $V_R = 0\text{ V}$	145	
			t = 8.3 ms, 60 Hz sine, $V_R = 0\text{ V}$	155	
$I^2t$	$I^2t$ Value for Fusing	$T_{vj} = 45\text{ °C}$	t = 10 ms, 50 Hz sine, $V_R = 0\text{ V}$	145	$\text{A}^2\text{s}$
			t = 8.3 ms, 60 Hz sine, $V_R = 0\text{ V}$	140	
		$T_{vj} = 150\text{ °C}$	t = 10 ms, 50 Hz sine, $V_R = 0\text{ V}$	105	
			t = 8.3 ms, 60 Hz sine, $V_R = 0\text{ V}$	100	
$V_{RSM}/V_{DSM}$	Maximum Non-repetitive Reverse/Forward Blocking Voltage	$T_{vj} = 25\text{ °C}$	1300	V	
$V_{RRM}/V_{DRM}$	Maximum Repetitive Reverse/Forward Blocking Voltage	$T_{vj} = 25\text{ °C}$	1200	V	
$di/dt_{cr}$	Critical Rate of Rise of On-state Current	$t_p = 200\text{ }\mu\text{s}$ ; $f = 50\text{ Hz}$ ; $di_G/dt = 0.3\text{ A}/\mu\text{s}$ ; $I_G = 0.3\text{ A}$ ; $T_{vj} = 150\text{ °C}$ ; $V = 2/3 V_{DRM}$	Repetitive, $I_T = 45\text{ A}$	150	$\text{A}/\mu\text{s}$
			Non-repetitive, $I_T = 15\text{ A}$	500	
$dv/dt_{cr}$	Critical Rate of Rise of Voltage	$V = 2/3 V_{DRM}$ , $R_{GK} = \infty$ , method 1 (linear voltage rise), $T_{vj} = 150\text{ °C}$	500	$\text{V}/\mu\text{s}$	
$P_{GM}$	Maximum Gate Power Dissipation	$T_C = 150\text{ °C}$	$t_p = 30\text{ }\mu\text{s}$	5	W
			$t_p = 300\text{ }\mu\text{s}$	1	
$P_{GAV}$	Average Gate Power Dissipation	$T_C = 150\text{ °C}$	0.2	W	
$P_{tot}$	Total Power Dissipation	$T_C = 25\text{ °C}$	130	W	
$T_{stg}$	Storage Temperature Range	–	–40 to 150	$^{\circ}\text{C}$	
$T_{op}$	Operating Temperature Range	–	–40 to 125	$^{\circ}\text{C}$	
$T_{vj}$	Virtual Junction Temperature Range	–	–40 to 150	$^{\circ}\text{C}$	

## Thermal Characteristics

Symbol	Characteristics	Value			Units
		Min.	Typ.	Max.	
$R_{thJC}$	Thermal Resistance, Junction to Case	–	–	0.95	$\text{K}/\text{W}$
$R_{thCH}$	Thermal Resistance, Case to Heatsink	–	0.3	–	$\text{K}/\text{W}$

### Electrical Characteristics

Symbol	Characteristics	Conditions	Value			Units		
			Min.	Typ.	Max.			
I <sub>GT</sub>	Gate Trigger Current	T <sub>vj</sub> = 25 °C	V <sub>D</sub> = 6 V	-	-	±48	mA	
		T <sub>vj</sub> = -40 °C		-	-	±60		
V <sub>GT</sub>	Gate Trigger Voltage	T <sub>vj</sub> = 25 °C	V <sub>D</sub> = 6 V	-	-	1.5	V	
		T <sub>vj</sub> = -40 °C		-	-	1.6		
I <sub>GD</sub>	Gate Non-trigger Current	V <sub>D</sub> = 2/3 V <sub>DRM</sub> ; T <sub>vj</sub> = 150 °C	-	-	±1	mA		
V <sub>GD</sub>	Gate Non-trigger Voltage	V <sub>D</sub> = 2/3 V <sub>DRM</sub> ; T <sub>vj</sub> = 150 °C	-	-	0.2	V		
V <sub>T</sub>	Forward Voltage Drop	T <sub>vj</sub> = 25 °C	I <sub>T</sub> = 15 A	-	-	1.35	V	
				I <sub>T</sub> = 30 A	-	-		1.68
		T <sub>vj</sub> = 125 °C		I <sub>T</sub> = 15 A	-	-		1.35
				I <sub>T</sub> = 30 A	-	-		1.79
I <sub>L</sub>	Latching Current	t <sub>p</sub> = 10 μs; I <sub>G</sub> = 0.3 A; di <sub>G</sub> /dt = 0.3 A/μs; T <sub>vj</sub> = 25 °C	-	-	70	mA		
I <sub>H</sub>	Holding Current	V <sub>D</sub> = 6 V; R <sub>GK</sub> = ∞; T <sub>vj</sub> = 25 °C	-	-	50	mA		
V <sub>T0</sub>	Threshold Voltage <sup>1</sup>	T <sub>vj</sub> = 150 °C	-	-	0.89	V		
r <sub>T</sub>	Slope Resistance <sup>1</sup>	T <sub>vj</sub> = 150 °C	-	-	30	mΩ		
C <sub>J</sub>	Junction Capacitance	V <sub>R</sub> = 400 V, f = 1 MHz, T <sub>vj</sub> = 25 °C	-	9	-	pF		
t <sub>gd</sub>	Gate Controlled Delay Time	V <sub>D</sub> = 1/2 V <sub>DRM</sub> ; I <sub>G</sub> = 0.3 A; di <sub>G</sub> /dt = 0.3 A/μs; T <sub>vj</sub> = 25 °C	-	-	2	μs		
t <sub>q</sub>	Turn-off Time	V <sub>R</sub> = 100 V; I <sub>T</sub> = 15 A; V = 2/3 V <sub>DRM</sub> ; di/dt = 10 A/μs; dv/dt = 20 V/μs; t <sub>p</sub> = 200 μs; T <sub>vj</sub> = 125 °C	-	150	-	μs		

Note 1: For power loss calculation only

### Package

Symbol	Characteristics	Conditions	Value			Units
			Min.	Typ.	Max.	
I <sub>RMS</sub>	RMS Current	per terminal	-	-	35	A
F <sub>C</sub>	Mounting force with clip	-	20	-	60	N
G	Weight	-	-	1.5	-	g
d <sub>Spp/App</sub>	creepage distance on surface / striking distance through air	terminal to terminal	4.2	-	-	mm
d <sub>Spb/Abp</sub>		terminal to backside	4.7	-	-	

### Equivalent Circuits for Simulation (T<sub>vj</sub> = 150 °C)

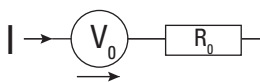

Symbol	Characteristics	Value	Units
V <sub>0 max</sub>	Threshold Voltage	0.89	V
R <sub>0 max</sub>	Slope Resistance <sup>1</sup>	27	mΩ

Note 1: On die level

**Characteristic Curves**

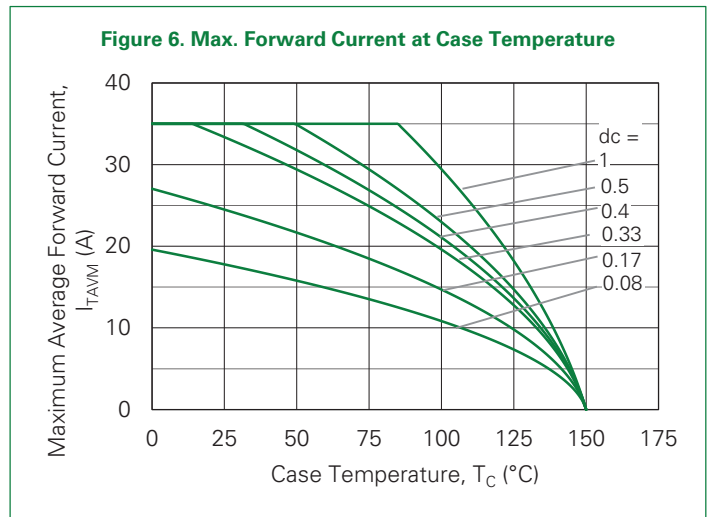
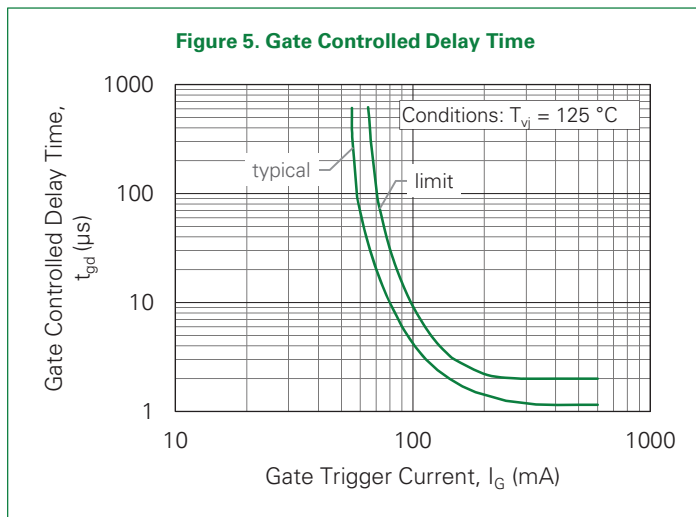
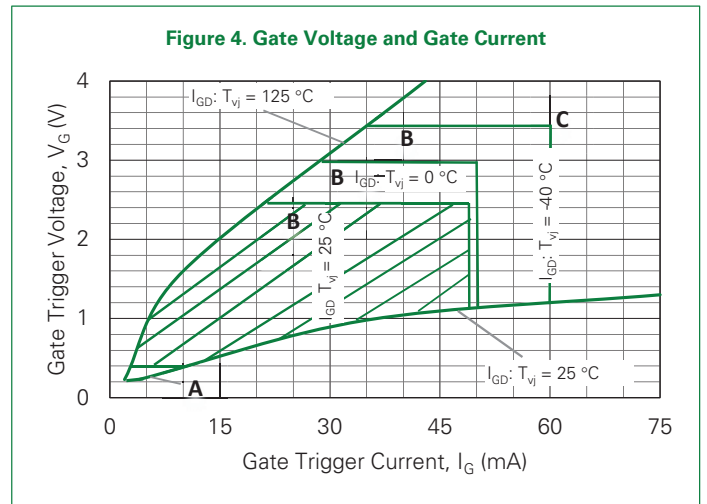
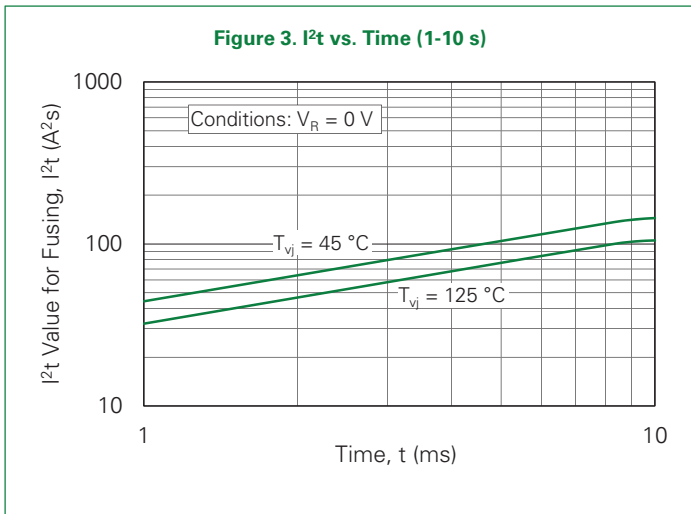
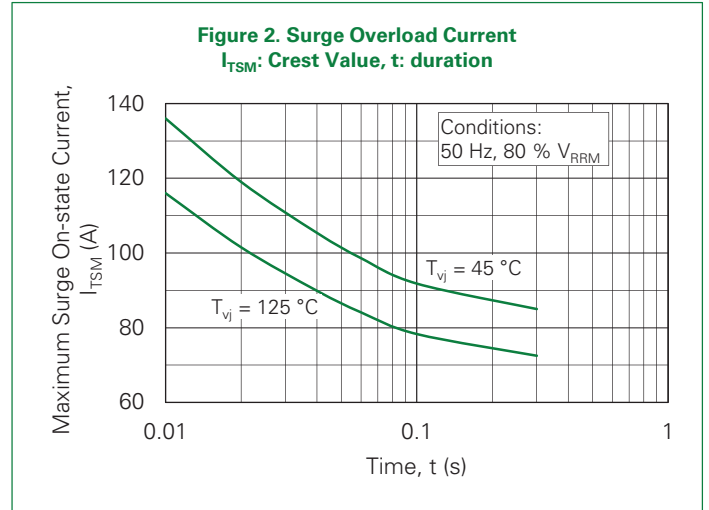
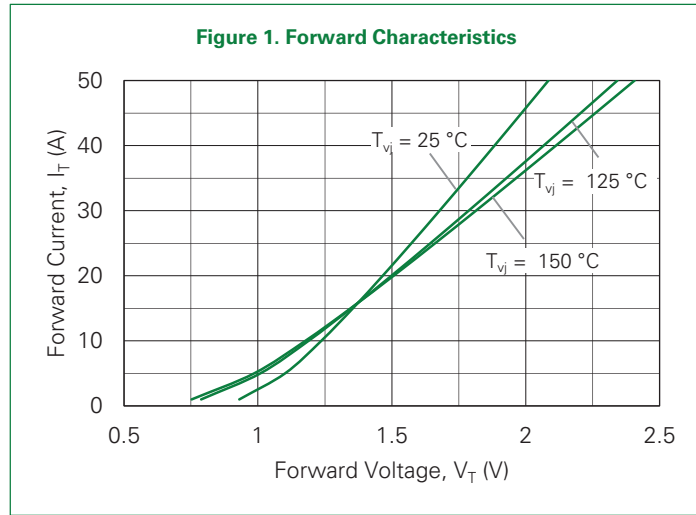

**Figure 7a. Power Dissipation vs. Direct Output Current**

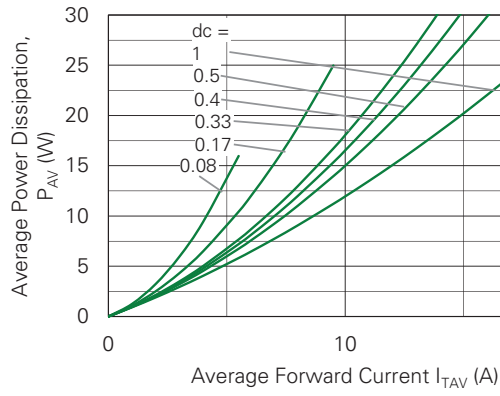

**Figure 7b. Power Dissipation vs. Ambient Temperature**

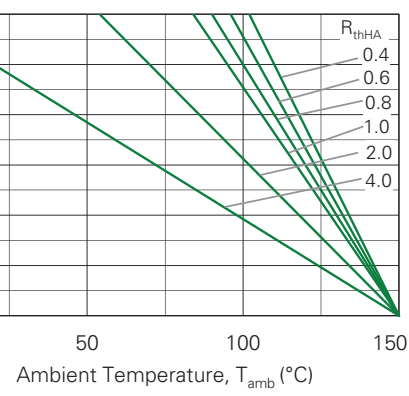

**Figure 8. Transient Thermal Impedance, Junction to Case**

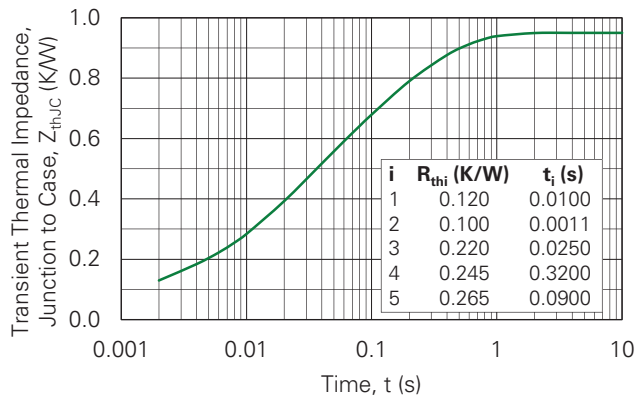

**Part Outline Drawing** (TO-263-2L) (D<sup>2</sup>PAK-HV)

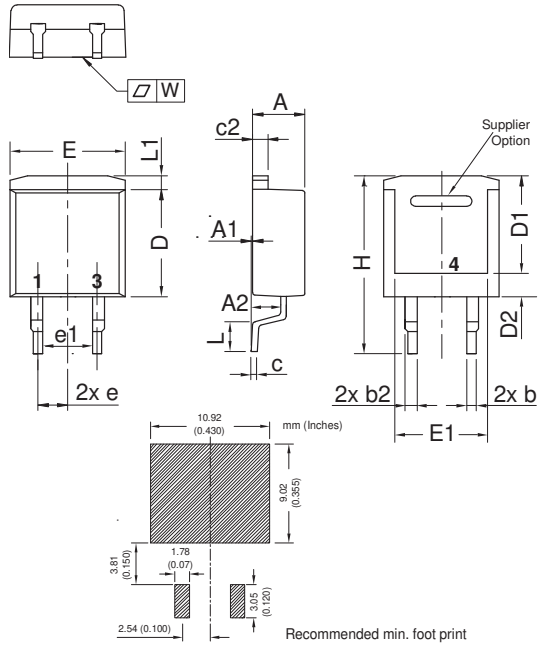

Symbol	Millimeters		Inches	
	Min.	Max.	Min.	Max.
A	4.06	4.83	0.160	0.190
A1	typ. 0.10		typ. 0.004	
A2	2.41		0.095	
b	0.51	0.99	0.020	0.039
b2	1.14	1.40	0.045	0.055
c	0.40	0.74	0.016	0.029
c2	1.14	1.40	0.045	0.055
D	8.38	9.40	0.330	0.370
D1	8.00	8.89	0.315	0.350
D2	2.3		0.091	
E	9.65	10.41	0.380	0.410
E1	6.22	8.50	0.245	0.335
e	2.54 BSC		0.100 BSC	
e1	4.28		0.169	
H	14.61	15.88	0.575	0.625
L	1.78	2.79	0.070	0.110
L1	1.02	1.68	0.040	0.066
W	typ. 0.02	0.040	typ. 0.0008	0.002

**Note:** All dimensions conform with and/or within JEDEC standard.

**Product Selector**

Part Number	Voltage Class	Package
CLA30MT1200NPZ	1200 V	TO-263-2L (D <sup>2</sup> PAK-HV)
CLA30MT1200NPB	1200 V	TO-220AB-3L

**Packing Options**

Part Number	Marking	Packing Mode	Quantity
CLA30MT1200NPZ-TRL	CLA30MT1200NPZ	Tape & Reel	800
CLA30MT1200NPZ-TUB	CLA30MT1200NPZ	Tube	50

**Part Numbering and Marking**

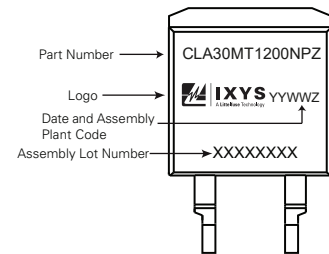
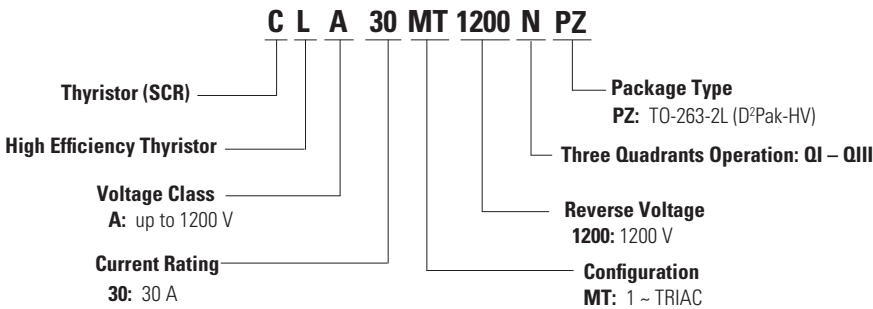

**Disclaimer Notice**

Information furnished is believed to be accurate and reliable. However, users should independently evaluate the suitability of and test each product selected for their own applications. Littelfuse products are not designed for, and may not be used in, all applications. Read complete Disclaimer Notice at <http://www.littelfuse.com/disclaimer-electronics>.



Part of:

