

MAC16HCDG, MAC16HCMG, MAC16HCNG

TRIAC – 400V - 800V

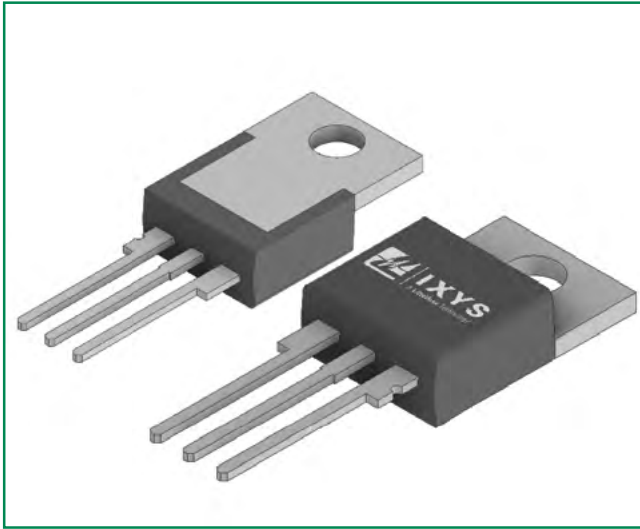

Description

Designed primarily for full wave ac control applications, such as motor controls, heating controls or dimmers; or wherever full wave, silicon gate-controlled devices are needed.

Features

- High Commutating di/dt and High Immunity to dv/dt @ 125°C
- Uniform Gate Trigger Currents in Three Quadrants, Q1, Q2, and Q3
- Blocking Voltage to 800 Volts
- On-State Current Rating of 16 Amperes RMS at 80°C
- High Surge Current Capability – 150 Amperes
- Industry Standard TO-220 Package for Ease of Design
- Glass Passivated Junctions for Reliability and Uniformity
- These Devices are Pb-Free and are RoHS Compliant

Additional Information



Resources



Accessories



Samples

Pin Out

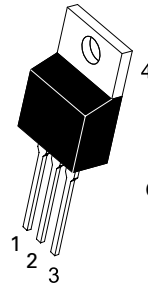

**TO-220AB
CASE 221A
STYLE 4**

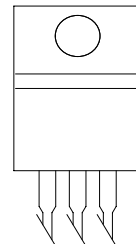

MAC16HCDG, MAC16HCMG, MAC16HCNG

TRIAC – 400V - 800V

Maximum Ratings ($T_J = 25^\circ\text{C}$ unless otherwise noted)

Rating	Symbol	Value	Unit
Peak Repetitive Off-State Voltage (Note 1) (– 40 to 125°C, Sine Wave, 50 to 60 Hz, Gate Open)	MAC16HCD MAC16HCM MAC16HCN V_{DRM} V_{RRM}	400 600 800	V
On-State RMS Current (Full Cycle Sine Wave, 60 Hz, $T_C = 80^\circ\text{C}$)	$I_T (RMS)$	16	A
Peak Non-Repetitive Surge Current (One Full Cycle Sine Wave, 60 Hz, $T_C = 125^\circ\text{C}$)	I_{TSM}	150	A
Circuit Fusing Consideration (t = 8.3 ms)	I^2t	93	A ² sec
Peak Gate Power ($T_C = 80^\circ\text{C}$, Pulse Width $\leq 1.0 \mu\text{s}$)	P_{GM}	20	W
Average Gate Power (t = 8.3 ms, $T_C = 80^\circ\text{C}$)	$P_{G(AV)}$	0.5	W
Operating Junction Temperature Range	T_J	-40 to +125	°C
Storage Temperature Range	T_{stg}	-40 to +150	°C

Stresses exceeding Maximum Ratings may damage the device. Maximum Ratings are stress ratings only. Functional operation above the Recommended Operating Conditions is not implied. Extended exposure to stresses above the Recommended Operating Conditions may affect device reliability.

1. V_{DRM} and V_{RRM} for all types can be applied on a continuous basis. Ratings apply for zero or negative gate voltage; however, positive gate voltage shall not be applied concurrent with negative potential on the anode. Blocking voltages shall not be tested with a constant current source such that the voltage ratings of the devices are exceeded.

Thermal Characteristics

Rating	Symbol	Value	Unit
Thermal Resistance, Junction-to-Case (AC) Junction-to-Ambient	$R_{\theta JC}$ $R_{\theta JA}$	2.2 62.5	°C/W
Maximum Lead Temperature for Soldering Purposes, 1/8" from case for 10 seconds	T_L	260	°C

Electrical Characteristics - OFF ($T_J = 25^\circ\text{C}$ unless otherwise noted ; Electricals apply in both directions)

Characteristic	Symbol	Min	Typ	Max	Unit
Peak Repetitive Blocking Current ($V_D = V_{DRM} = V_{RRM}$; Gate Open)	I_{DRM} I_{RRM}	-	-	0.01	mA
		-	-	2.0	

Electrical Characteristics - ON ($T_J = 25^\circ\text{C}$ unless otherwise noted; Electricals apply in both directions)

Characteristic	Symbol	Min	Typ	Max	Unit	
Peak On-State Voltage (Note 2) ($I_{TM} = \pm 21 \text{ A Peak}$)	V_{TM}	–	–	1.6	V	
Gate Trigger Current (Continuous dc) ($V_D = 12 \text{ V}$, $R_L = 100 \Omega$)	I_{GT}	MT2(+), G(+)	10	16	50	mA
		MT2(+), G(–)	10	18	50	
		MT2(–), G(–)	10	22	50	
Gate Trigger Voltage (Continuous dc) ($V_D = 12 \text{ V}$, $R_L = 100 \Omega$)	V_{GT}	MT2(+), G(+)	0.5	0.8	1.5	V
		MT2(+), G(–)	0.5	0.73	1.5	
		MT2(–), G(–)	0.5	0.82	1.5	
Latching Current ($V_D = 24 \text{ V}$, $I_G = 50 \text{ mA}$)	V_{GD}	MT2(+), G(+)	–	33	60	V
		MT2(+), G(–)	–	36	80	
		MT2(–), G(–)	–	33	50	
Holding Current ($V_D = 12 \text{ V}_{dc}$, Gate Open, Initiating Current = $\pm 150 \text{ mA}$)	I_H	–	20	50	mA	

Product parametric performance is indicated in the Electrical Characteristics for the listed test conditions, unless otherwise noted. Product performance may not be indicated by the Electrical Characteristics if operated under different conditions.

2. Indicates Pulse Test: Pulse Width $\leq 2.0 \text{ ms}$, Duty Cycle $\leq 2\%$.

MAC16HCDG, MAC16HCMG, MAC16HCNG

TRIAC – 400V - 800V

Dynamic Characteristics

Characteristic	Symbol	Min	Typ	Max	Unit
Rate of Change of Commutating Current ($V_D = 400\text{ V}$, $I_{TM} = 6.0\text{ A}$, Commutating $dV/dt = 20\text{ V}/\mu\text{s}$, Gate Open, $T_J = 125^\circ\text{C}$, $f = 250\text{ Hz}$, $C_L = 10\text{ }\mu\text{F}$, $L_L = 40\text{ mH}$, with Snubber)	$(di/dt)_c$	15.0	–	–	A/ms
Critical Rate of Rise of Off-State Voltage ($V_D = \text{Rated } V_{DRM}$, Exponential Waveform, Gate Open, $T_J = 125^\circ\text{C}$)	dv/dt	750	–	–	V/ μs
Repetitive Critical Rate of Rise of On-State Current IPK = 50 A; PW = 40 μsec ; $diG/dt = 200\text{ mA}/\mu\text{sec}$; $f = 60\text{ Hz}$	di/dt	–	–	10	A/ μs

Voltage Current Characteristic of SCR

Symbol	Parameter
V_{DRM}	Peak Repetitive Forward Off State Voltage
I_{DRM}	Peak Forward Blocking Current
V_{RRM}	Peak Repetitive Reverse Off State Voltage
I_{RRM}	Peak Reverse Blocking Current
V_{TM}	Maximum On State Voltage
I_H	Holding Current

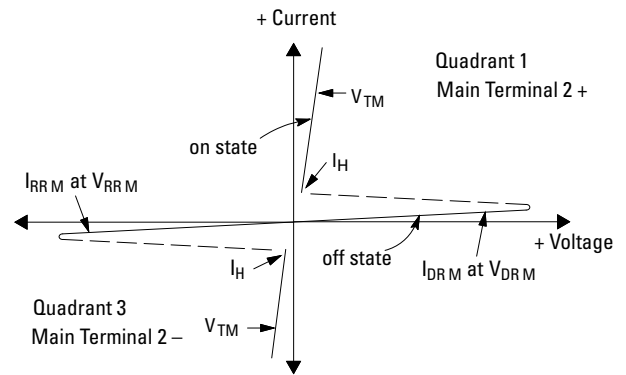

Quadrant Definitions for a Triac

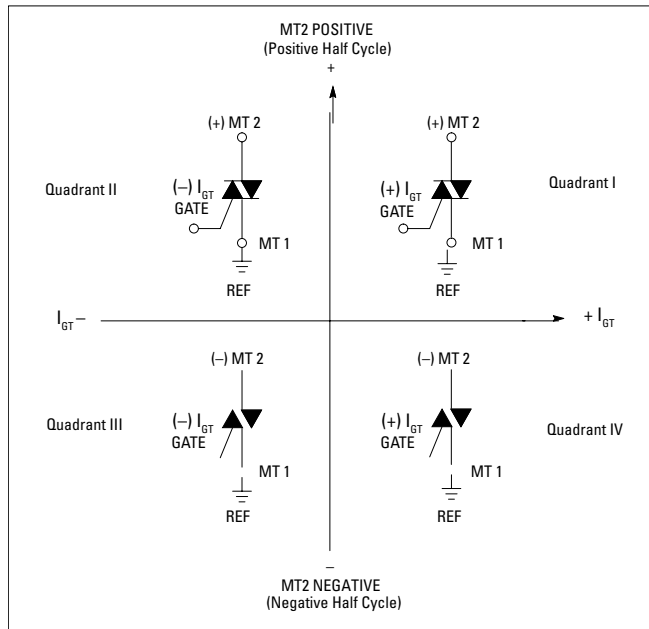

All polarities are referenced to MT1.
With in-phase signals (using standard AC lines) quadrants I and III are used.

MAC16HCDG, MAC16HCMG, MAC16HCNG

TRIAC – 400V - 800V

Figure 1. Typical Gate Trigger Current vs Junction Temperature

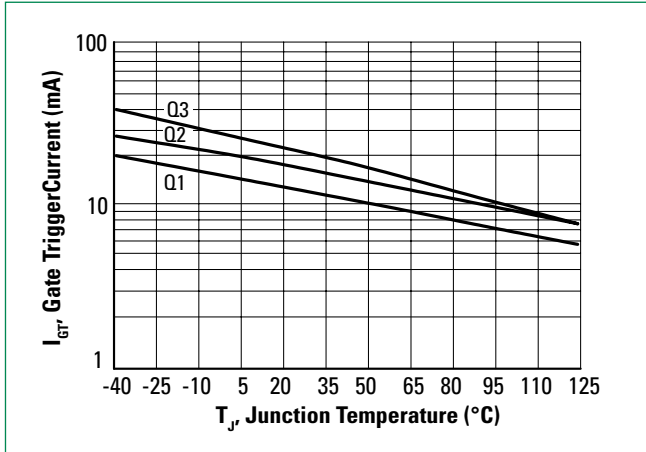

Figure 2. Typical Gate Trigger Voltage vs Junction Temperature

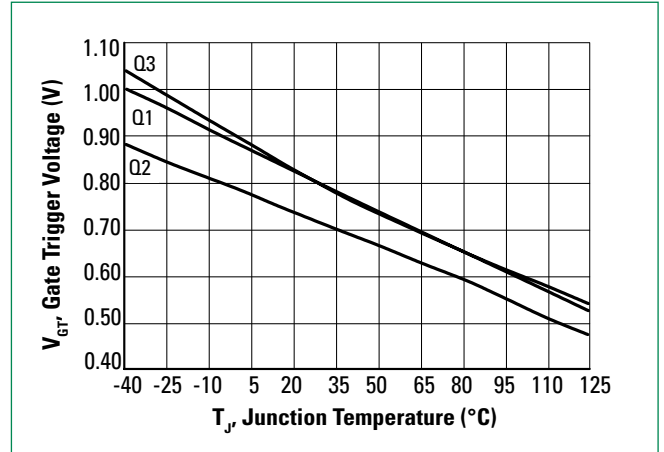

Figure 3. Typical Holding Current vs Junction Temperature

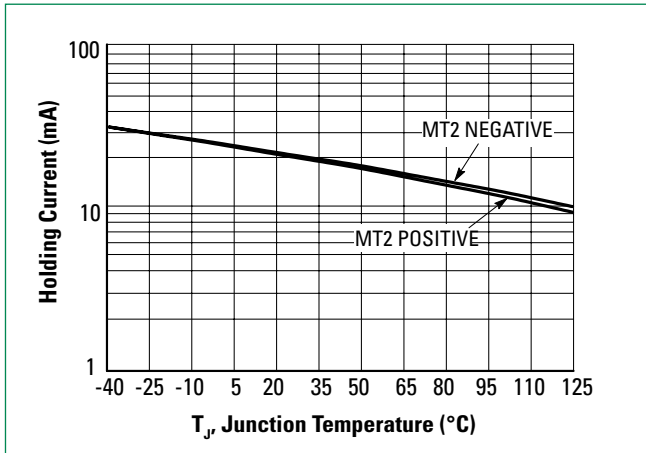

Figure 4. Typical Latching Current vs Junction Temperature

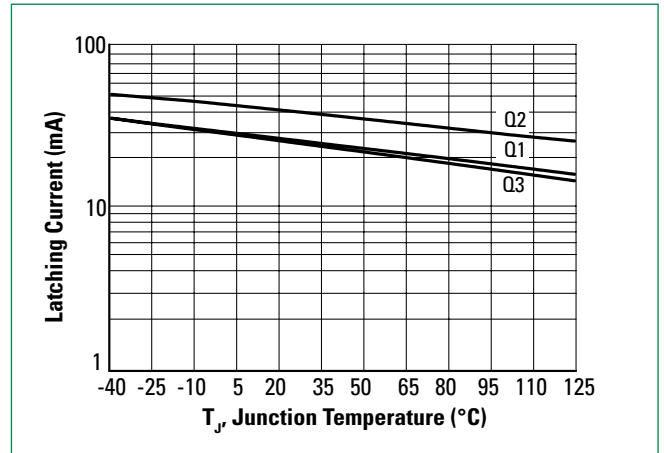

Figure 5. Typical RMS Current Derating

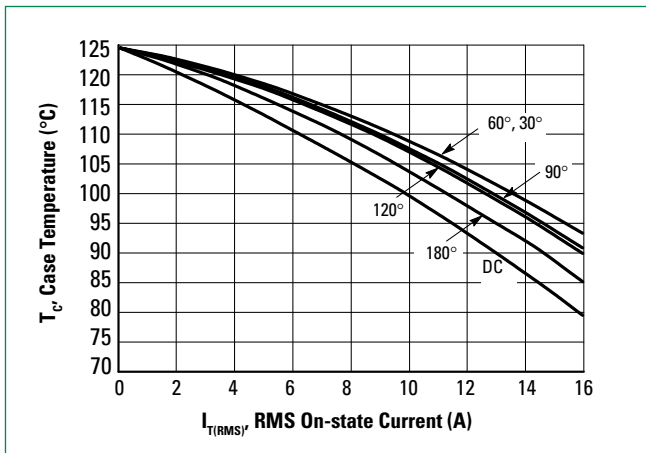
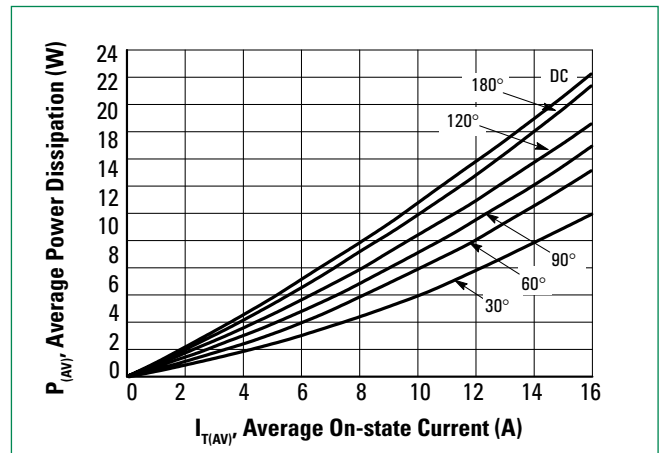

Figure 6. On-State Power Dissipation



MAC16HCDG, MAC16HCMG, MAC16HCNG

TRIAC – 400V - 800V

Figure 7. Typical On-State Characteristics

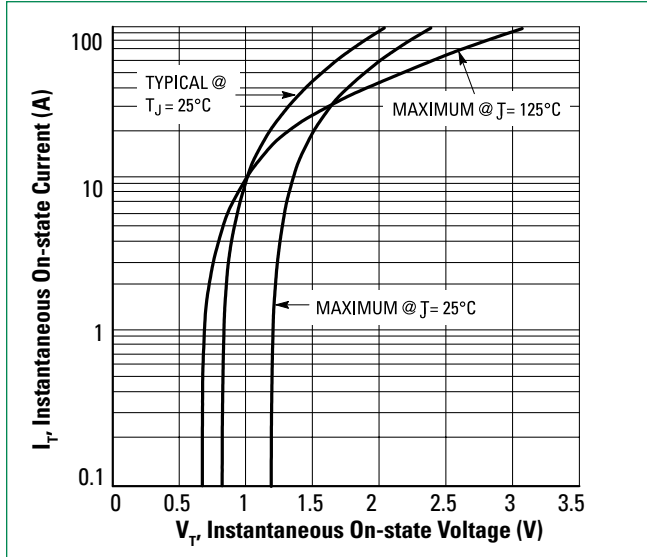
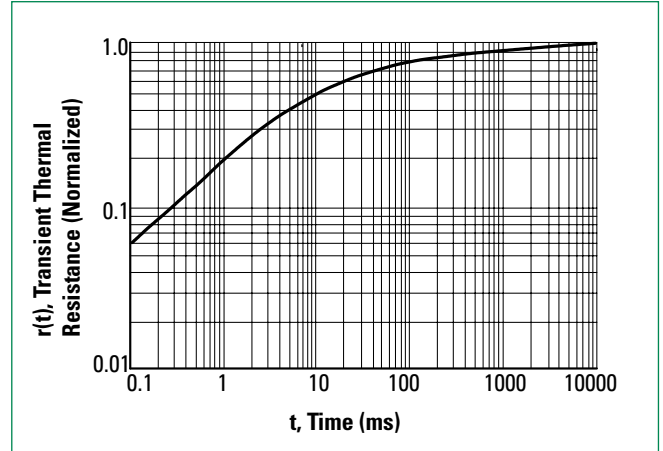

Figure 8. Typical Thermal Response



MAC16HCDG, MAC16HCMG, MAC16HCNG

TRIAC – 400V - 800V

Dimensions

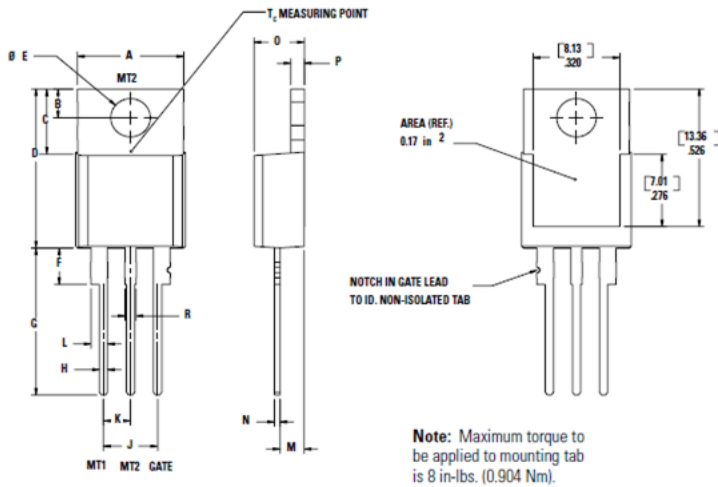

Part Marking System

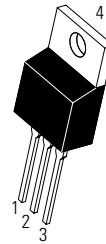

**TO-220AB
CASE 221A
STYLE 12**

- x =D, M or N
- Y =Year
- M =Month
- A =Assembly Site
- XX =Lot Serial Code
- G =Pb-Free Package



Dim	Millimeters		Inches	
	Min	Max	Min	Max
A	0.380	0.420	9.65	10.67
B	0.105	0.115	2.67	2.92
C	0.230	0.250	5.84	6.35
D	0.590	0.620	14.99	15.75
E	0.142	0.147	3.61	3.73
F	0.110	0.130	2.79	3.30
G	0.540	0.575	13.72	14.61
H	0.025	0.035	0.64	0.89
J	0.195	0.205	4.95	5.21
K	0.095	0.105	2.41	2.67
L	0.060	0.075	1.52	1.91
M	0.085	0.095	2.16	2.41
N	0.018	0.024	0.46	0.61
O	0.178	0.188	4.52	4.78
P	0.045	0.060	1.14	1.52
R	0.038	0.048	0.97	1.22

Pin Assignment	
1	Main Terminal 1
2	Main Terminal 2
3	Gate
4	Main Terminal 2

Ordering Information

Device	Package	Shipping
MAC16HCDG	TO-220 (Pb-Free)	1000 Units/ Box
MAC16HCMG		
MAC16HCNG		

Disclaimer Notice - Information furnished is believed to be accurate and reliable. However, users should independently evaluate the suitability of and test each product selected for their own applications. Littelfuse products are not designed for, and may not be used in, all applications. Read complete Disclaimer Notice at <http://www.littelfuse.com/disclaimer-electronics>.