

NYC222, NYC226, NYC228

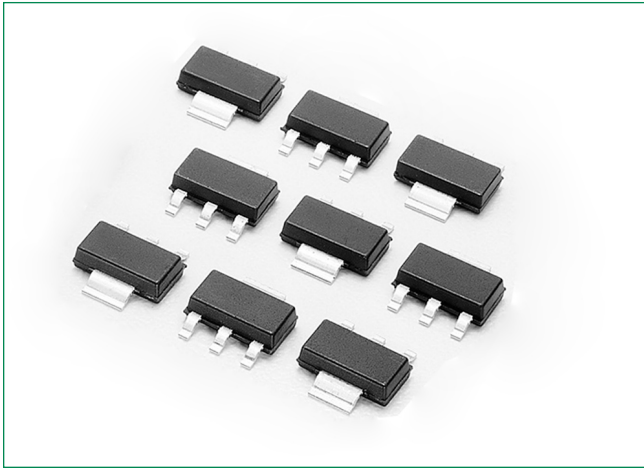

Description

Designed and tested for repetitive peak operation required for CD ignition, fuel ignitors, flash circuits, motor controls and low-power switching applications.

Features

- Blocking Voltage to 600 V
- High Surge Current – 15 A
- Very Low Forward “On” Voltage at High Current
- Low-Cost Surface Mount SOT-223 Package
- These are Pb-Free Devices

Pin Out

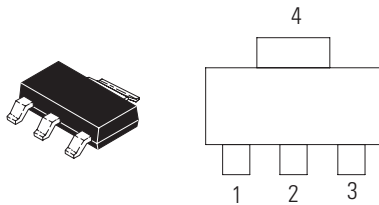

Functional Diagram

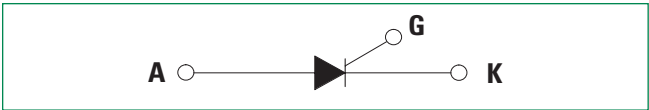

Pin Assignment	
1	K (Cathode)
2	A (Anode)
3	Gate
4	A (Anode)

Maximum Ratings ($T_J = 25^\circ\text{C}$ unless otherwise noted)

Rating	Symbol	Value	Unit
Peak Repetitive Off-State Voltage (Note 1) ($R_{GK} = I_{GT}, T_J = -40$ to $+110^\circ\text{C}$, Sine Wave, 50 to 60 Hz)	NYC222 NYC226 NYC228 V_{DRM}^* V_{RRM}	50 400 600	V
On-State RMS Current (180° Conduction Angles; $T_C = 80^\circ\text{C}$)	$I_{T(RMS)}$	1.5	A
Average On-State Current, ($T_C = 65^\circ\text{C}$, $f = 60$ Hz, Time = 1 sec)	$I_{T(AV)}$	2.0	A
Peak Non-repetitive Surge Current, @ $T_A = 25^\circ\text{C}$, (1/2 Cycle, Sine Wave, 60 Hz)	I_{TSM}	15	A
Circuit Fusing Considerations ($t = 8.3$ ms)	I^2t	0.9	A ² s
Forward Peak Gate Power (Pulse Width ≤ 1.0 sec, $T_A = 25^\circ\text{C}$)	P_{GM}	0.5	W
Forward Average Gate Power ($t = 8.3$ msec, $T_A = 25^\circ\text{C}$)	$P_{G(AV)}$	0.1	W
Forward Peak Gate Current (Pulse Width ≤ 1.0 s, $T_A = 25^\circ\text{C}$)	I_{FGM}	0.2	A
Reverse Peak Gate Voltage (Pulse Width ≤ 1.0 μs , $T_A = 25^\circ\text{C}$)	V_{RGM}	5.0	V
Operating Junction Temperature Range @ Rated V_{RRM} and V_{DRM}	T_J	-40 to +110	$^\circ\text{C}$
Storage Temperature Range	T_{stg}	-40 to +150	$^\circ\text{C}$

Stresses exceeding Maximum Ratings may damage the device. Maximum Ratings are stress ratings only. Functional operation above the Recommended Operating Conditions is not implied. Extended exposure to stresses above the Recommended Operating Conditions may affect device reliability.

- V_{DRM} and V_{RRM} for all types can be applied on a continuous basis. Ratings apply for zero or negative gate voltage; however, positive gate voltage shall not be applied concurrent with negative potential on the anode. Blocking voltages shall not be tested with a constant current source such that the voltage ratings of the devices are exceeded.

Thermal Characteristics

Rating	Symbol	Value	Unit
Thermal Resistance, Junction-to-Ambient PCB Mounted	$R_{\theta JA}$	156	mW
Thermal Resistance, Junction-to-Tab Measured on MT2 Tab Adjacent to Epoxy	$R_{\theta JT}$	25	$^\circ\text{C/W}$
Maximum Device Temperature for Soldering Purposes for 10 Secs Maximum	T_L	260	$^\circ\text{C}$

Electrical Characteristics - OFF ($T_C = 25^\circ\text{C}$ unless otherwise noted)

Characteristic	Symbol	Min	Typ	Max	Unit
Peak Repetitive Blocking Current ($V_{AK} = V_{DRM} = V_{RRM}$; $R_{GK} = 1000 \Omega$)	I_{DRM}^* I_{RRM}	-	-	10	μA
		-	-	200	μA

Electrical Characteristics - ON ($T_J = 25^\circ\text{C}$ unless otherwise noted; Electricals apply in both directions)

Characteristic	Symbol	Min	Typ	Max	Unit	
Peak Forward On-State Voltage (Note 2) ($I_{TM} = 2.2$ A Peak)	V_{TM}	-	1.2	1.7	V	
Gate Trigger Current (Note 3) ($V_{AK} = 7$ V, $R_L = 100 \Omega$)	I_{GT}	$T_C = 25^\circ\text{C}$	-	30	200	μA
		$T_C = -40^\circ\text{C}$	-	-	500	
Gate Trigger Voltage (dc) (Note 3) ($V_{AK} = 7$ Vdc, $R_L = 100 \Omega$)	V_{GT}	$T_C = 25^\circ\text{C}$	-	-	0.8	V
		$T_C = -40^\circ\text{C}$	-	-	1.2	
Gate Non-Trigger Voltage ($V_{AK} = V_{DRM}$, $R_L = 100 \Omega$)	V_{GD}	0.1	-	-	V	
Holding Current ($V_{AK} = 12$ V, $R_{GK} = 1000 \Omega$) Initiating Current = 200 mA	I_H	$T_C = 25^\circ\text{C}$	-	2.0	5.0	mA
		$T_C = -40^\circ\text{C}$	-	-	10	

Dynamic Characteristics

Characteristic	Symbol	Min	Typ	Max	Unit
Critical Rate-of-Rise of Off State Voltage ($T_c = 110^\circ\text{C}$)	dv/dt	–	25	–	V/ μs
Critical Rate of Rise of On-State Current ($T_c = 110^\circ\text{C}$, $I_G = 2 \times I_{GT}$, $R_{GK} = 1 \text{ k}\Omega$)	di/dt	–	20	–	A/ μs

- 2. Pulse Width = 1.0 ms, Duty Cycle $\leq 1\%$.
- 3. RGK Current not included in measurement.

Voltage Current Characteristic of SCR

Symbol	Parameter
V_{DRM}	Peak Repetitive Forward Off State Voltage
I_{DRM}	Peak Forward Blocking Current
V_{RRM}	Peak Repetitive Reverse Off State Voltage
I_{RRM}	Peak Reverse Blocking Current
V_{TM}	Maximum On State Voltage
I_H	Holding Current

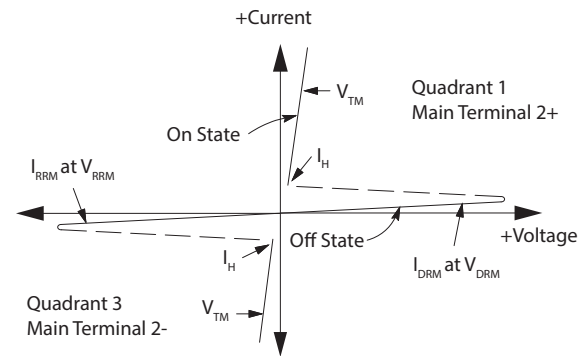

Current Derating

Figure 1. Maximum Case Temperature

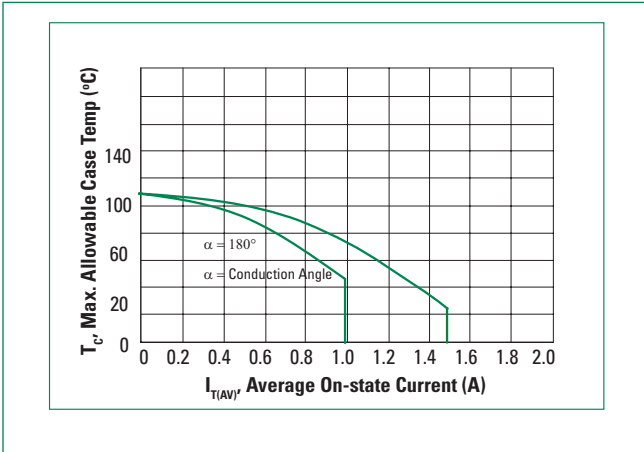

Figure 3. Typical Forward Voltage

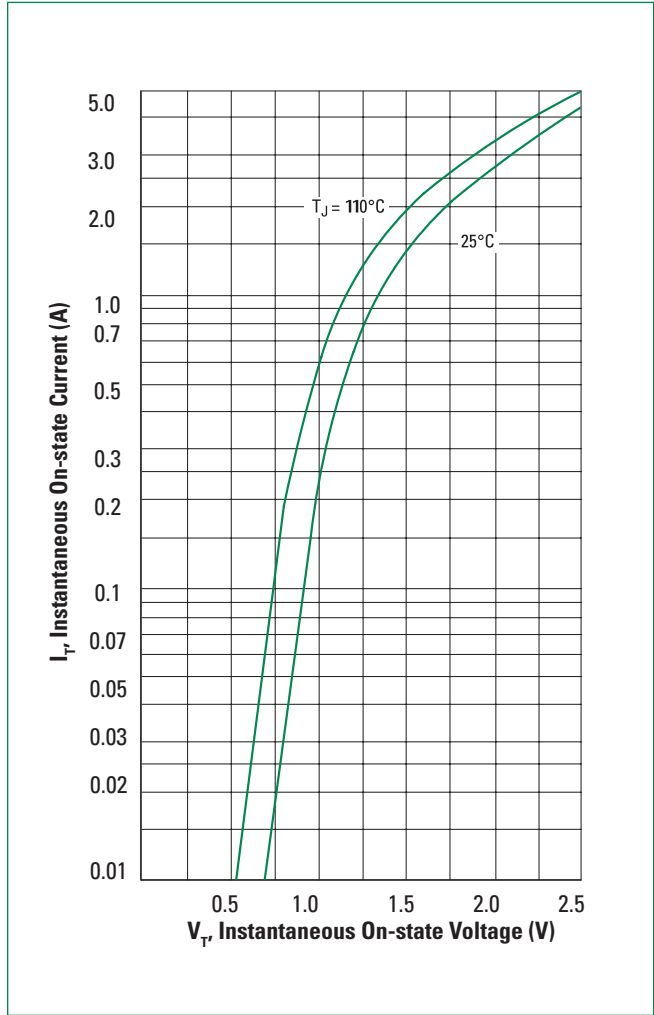

Figure 2. Maximum Ambient Temperature

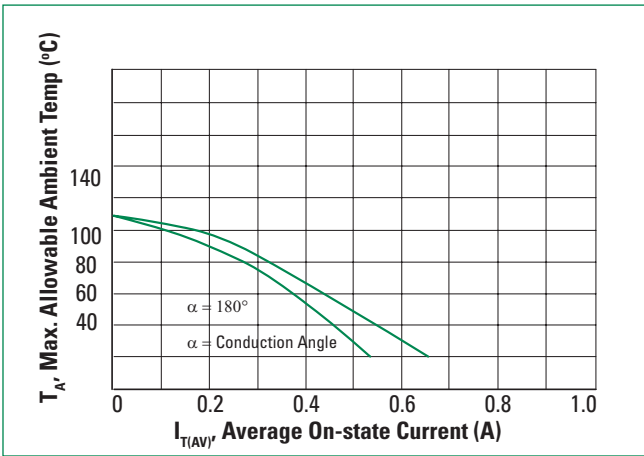

Figure 4. Thermal Response

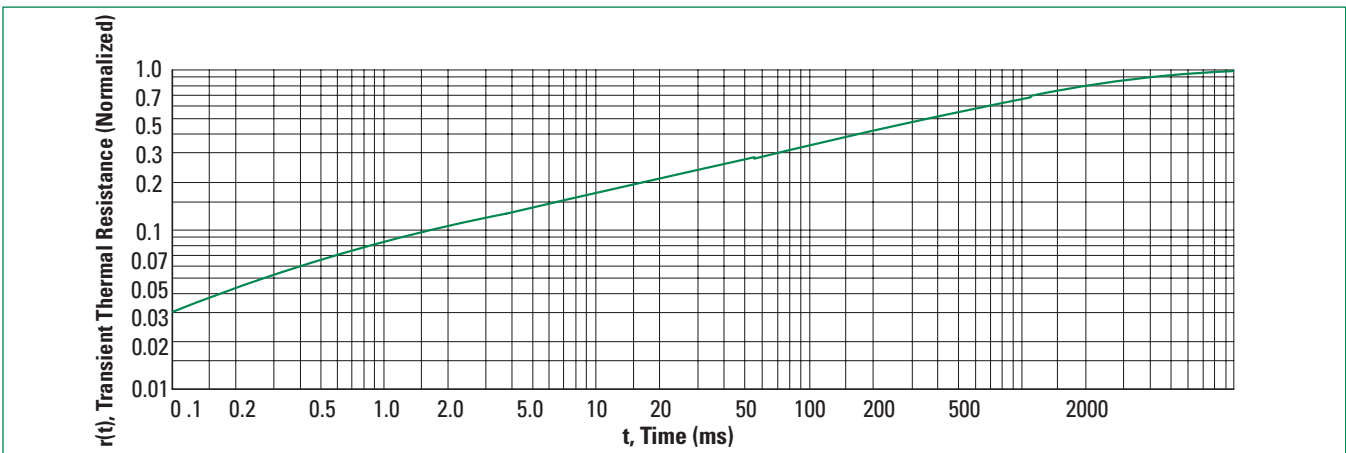

Figure 5. Typical Gate Trigger Voltage

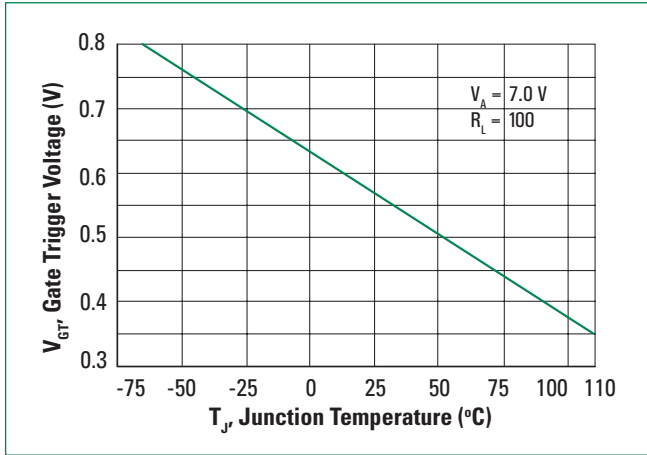

Figure 6. Typical Gate Trigger Current

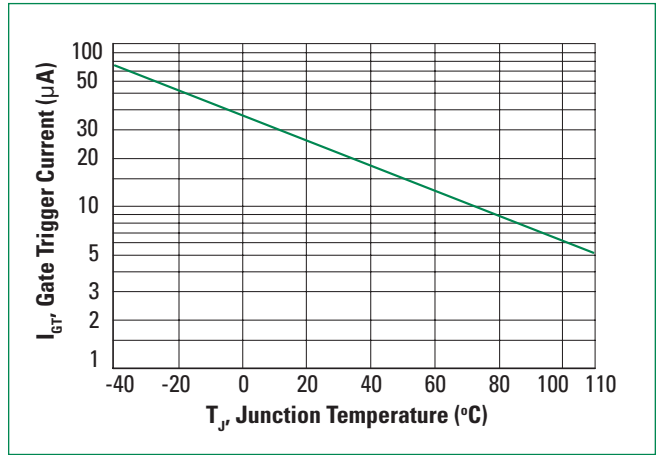

Figure 7. Typical Holding Current

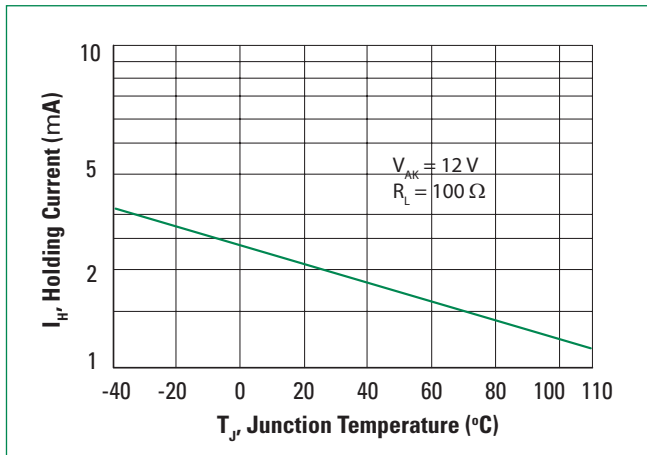
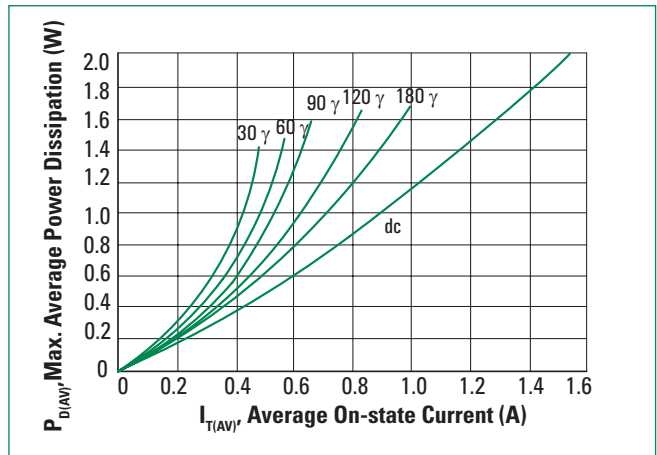
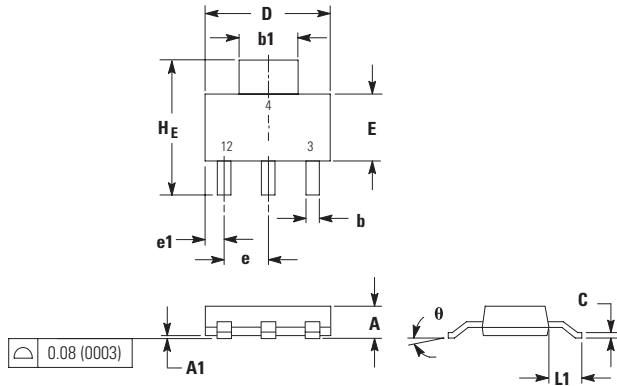

Figure 8. Power Dissipation



Dimensions



Dim	Inches			Millimeters		
	Min	Nom	Max	Min	Nom	Max
A	---	---	0.071	---	---	1.80
A1	0.001	0.003	0.005	0.02	0.07	0.13
b	0.026	0.030	0.033	0.66	0.75	0.84
b1	0.114	0.118	0.122	2.90	3.00	3.10
C	0.009	0.011	0.014	0.23	0.29	0.35
D	0.260	0.260	0.264	6.60	6.60	6.71
E	0.130	0.138	0.146	3.30	3.50	3.70
e	---	0.091	---	---	2.30	---
e1	0.030	0.037	0.045	0.75	0.95	1.15
L1	0.059	0.069	0.079	1.50	1.75	2.00
H _E	0.264	0.276	0.287	6.70	7.00	7.30
θ	0°	---	10°	0°	---	10°

1. DIMENSIONING AND TOLERANCING PER ANSI Y14.5M, 1982.
2. CONTROLLING DIMENSION: INCH.

Part Marking System

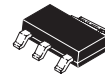

**SOT-223
Case 318E
Style 11**

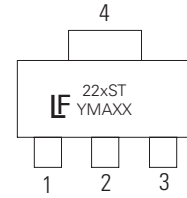

22xST = Device Code
x = 2, 6, or 8
Y = Year
M = Month
A = Assembly Site
XX = Lot Serial Code

Soldering Footprint

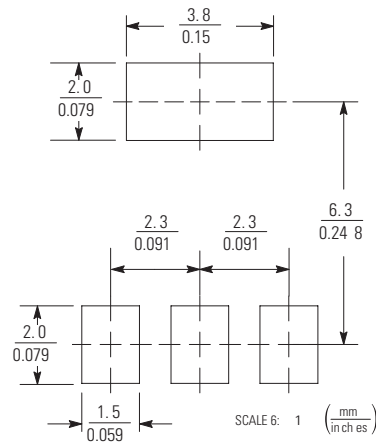

Ordering Information

Device	Package	Shipping
NYC222STT1G	SOT-223 (Pb-Free)	1000/Tape & Reel
NYC226STT1G	SOT-223 (Pb-Free)	
NYC228STT1G	SOT-223 (Pb-Free)	

Disclaimer Notice - Information furnished is believed to be accurate and reliable. However, users should independently evaluate the suitability of and test each product selected for their own applications. Littelfuse products are not designed for, and may not be used in, all applications. Read complete Disclaimer Notice at: www.littelfuse.com/disclaimer-electronics