

Q6035NAH5

35 A Alternistor (High Commutation) TRIACs

RoHS

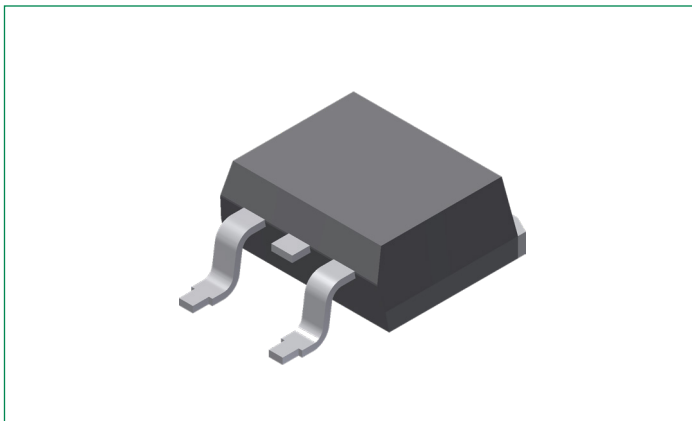

Description:

The 35 A bi-directional solid state switch series is designed for AC switching and phase control applications such as motor speed and temperature modulation controls, lighting controls, and static switching relays.

Standard type components normally operate in Quadrants I & III triggered from AC line.

Standard alternistor TRIAC components operate with in-phase signals in Quadrants I or III and only unipolar negative gate pulses for Quadrant II or III. The alternistor TRIAC will not operate in Quadrant IV. These are used in circuit applications requiring a high dv/dt capability.

Pinout Diagram TO-263AB

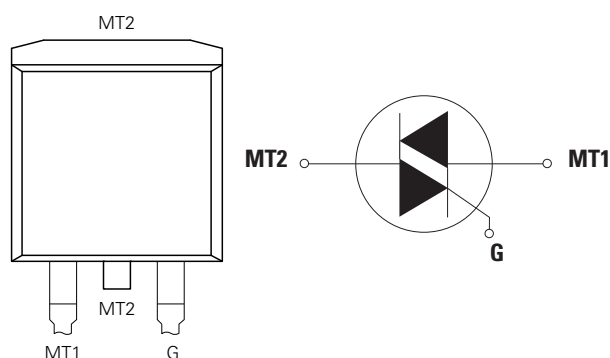

MT1: Main Terminal 1; **MT2:** Main Terminal 2; **G:** Gate

Features:

- Voltage capability of 600 V
- Surge capability up to 350 A at 60 Hz half cycle
- RoHS- compliant
- Glass passivated junctions
- AEC-Q101 qualified
- Automotive level manufacture control

Applications:

Excellent for AC switching and phase control applications such as heating, lighting, and motor speed controls.

Typical applications are AC solid-state switches, industrial power tools, exercise equipment, white goods and commercial appliances.

Alternistor Triacs (no snubber required) are used in applications with extremely inductive loads requiring highest commutation performance.

Product Summary

Characteristic	Value	Unit
$I_{T(RMS)}$	35	A
V_{DRM}/V_{RRM}	600	V
$I_{GT(Q1)}$	50	mA

Maximum Ratings - Alternistor TRIAC (3 Quadrants)

Symbol	Characteristics	Conditions	Value	Units
$I_{T(RMS)}$	On-state RMS Current (Full Sine Wave)	$T_C = 90^\circ\text{C}$	35	A
I_{TSM}	Non-repetitive Surge Peak On-state Current (Full cycle, T_{VJ} initial = 25°C)	$f = 50\text{ Hz}$, $t = 20\text{ ms}$	290	A
		$f = 60\text{ Hz}$, $t = 16.7\text{ ms}$	350	
I^2T	I^2T Value for Fusing	$t_p = 8.3\text{ ms}$	508	A^2s
di/dt	Critical Rate of Rise of On-state Current ($I_G = 200\text{ mA}$ with $\leq 0.1\text{ }\mu\text{s}$ rise time)	$f = 120\text{ Hz}$, $T_{VJ} = 125^\circ\text{C}$	100	$\text{A}/\mu\text{s}$
I_{GTM}	Peak Gate Trigger Current	$t_p = 20\text{ }\mu\text{s}$, $T_{VJ} = 125^\circ\text{C}$	4	A
$P_{G(AV)}$	Average Gate Power Dissipation	$T_{VJ} = 125^\circ\text{C}$	0.5	W
T_{stg}	Storage Temperature Range	–	–40 to 125	$^\circ\text{C}$
T_{VJ}	Operating Junction Temperature Range	–	–40 to 125	$^\circ\text{C}$

Thermal Characteristics

Symbol	Characteristics	Value	Units
$R_{th(JC)}$	Thermal Resistance, Junction to Case (AC)	0.85	K/W

Electrical Characteristics ($T_{VJ} = 25^\circ\text{C}$, unless otherwise specified) — **Alternistor TRIAC** (3 Quadrants)

Symbol	Characteristics	Conditions	Min.	Typ.	Max.	Units	
I_{GT}	DC Gate Trigger Current	$V_D = 12\text{ V}$, $R_L = 30\text{ }\Omega$	I – II – II	–	–	50 mA	
V_{GT}	DC Gate Trigger Voltage	$V_D = 12\text{ V}$, $R_L = 30\text{ }\Omega$	I – II – II	–	–	2 V	
V_{GD}	Gate Non-trigger Voltage	$V_D = V_{DRM}$, $R_L = 3.3\text{ k}\Omega$, $T_{VJ} = 125^\circ\text{C}$	I – II – II	0.2	–	– V	
I_H	Holding Current	$I_T = 400\text{ mA}$		–	–	75 mA	
dv/dt	Critical Rate-of-rise of Off-stage Voltage	$V_D = V_{DRM}$, Gate Open, $T_{VJ} = 125^\circ\text{C}$	600 V	400	–	– $\text{V}/\mu\text{s}$	
$(dv/dt)_c$	Critical Rate-of-rise of Commutation Voltage	$(di/dt)_c = 8.6\text{ A/ms}$, $T_{VJ} = 125^\circ\text{C}$		20	–	– $\text{V}/\mu\text{s}$	
t_{gt}	Turn-on Time	$I_G = 2 \times I_{GT}$, $P_W = 15\text{ }\mu\text{s}$, $I_T = 49.5\text{ A}_{pk}$	I – II	–	3	–	μs
			III	–	11	–	

Static Characteristics

Symbol	Characteristics	Conditions	Maximum Value	Units
V_{TM}	Peak On-state Voltage	$I_{TM} = 49.5\text{ A}$, $t_p = 380\text{ }\mu\text{s}$	1.5	V
I_{DRM}/I_{RRM}	Off-state Current, Peak Repetitive	$V_D = V_{DRM}/V_{RRM}$, $T_{VJ} = 25^\circ\text{C}$	10	μA
		$V_D = V_{DRM}/V_{RRM}$, $T_{VJ} = 125^\circ\text{C}$	2	mA

Characteristic Curves

Fig. 1. Definition of Quadrants

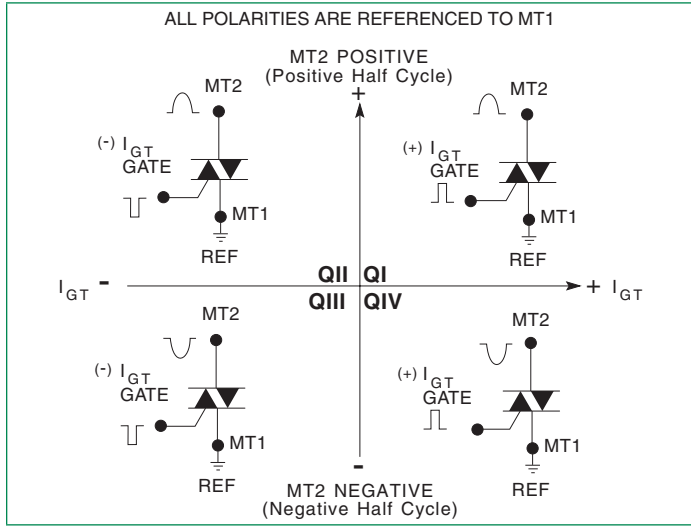

Note: Alternistors will not operate in QIV

Fig. 2. Normalized DC Gate Trigger Current for All Quadrants vs. Junction Temperature

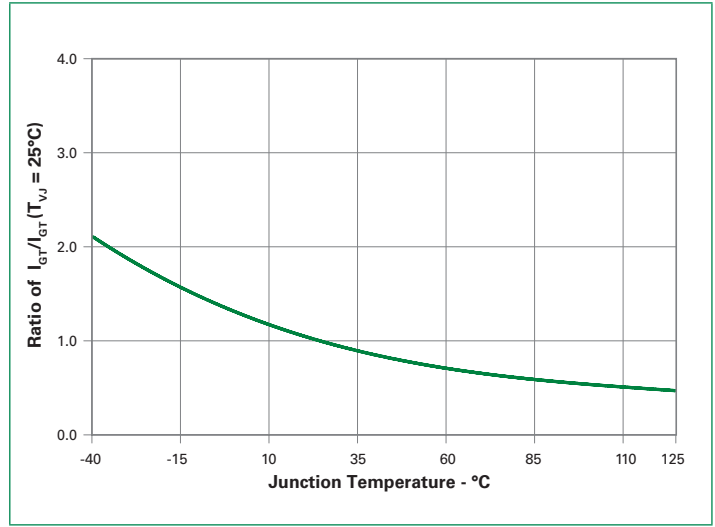

Fig. 3. Normalized DC Holding Current vs. Junction Temperature

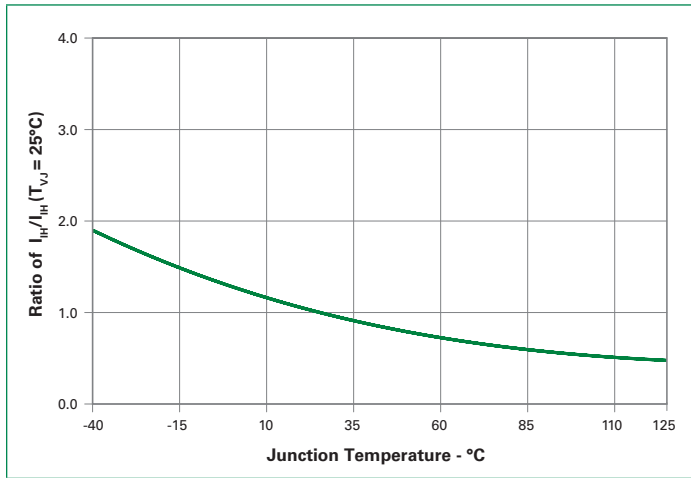

Fig. 4. Normalized DC Gate Trigger Voltage for all Quadrants vs. Junction Temperature

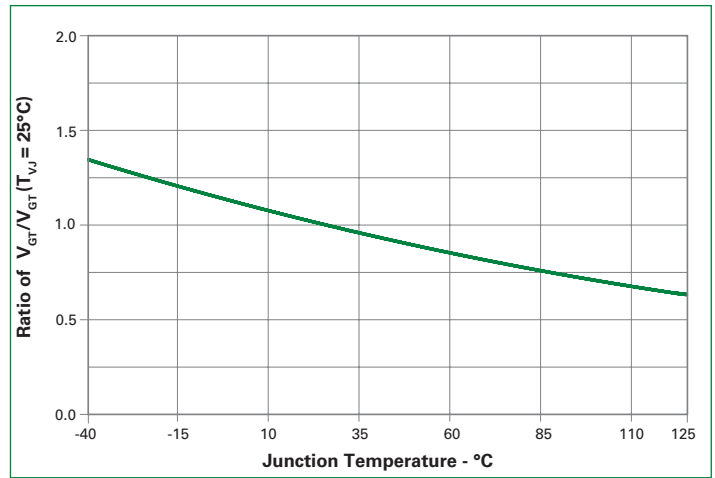

Fig. 5. Power Dissipation (Typical) vs. RMS On-state Current

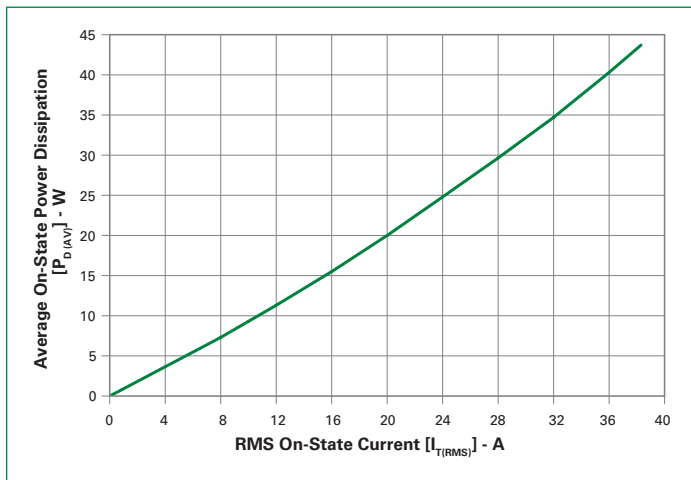

Fig. 6. Max. Allowable Case Temperature vs. On-state Current

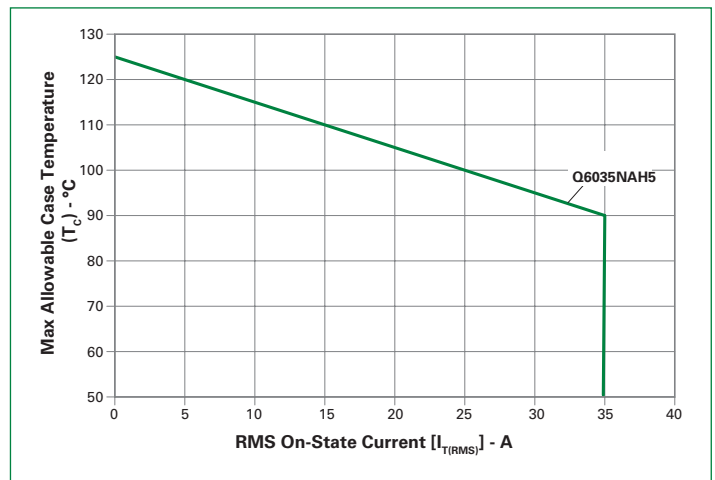

Fig. 7. Typical On-state Current vs. On-state Voltage

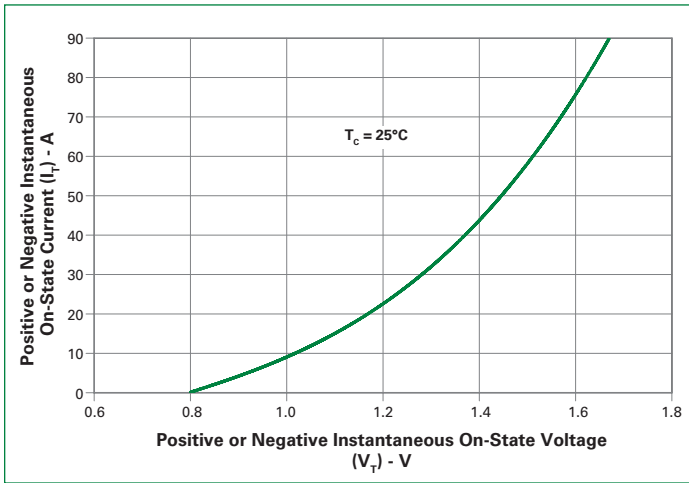
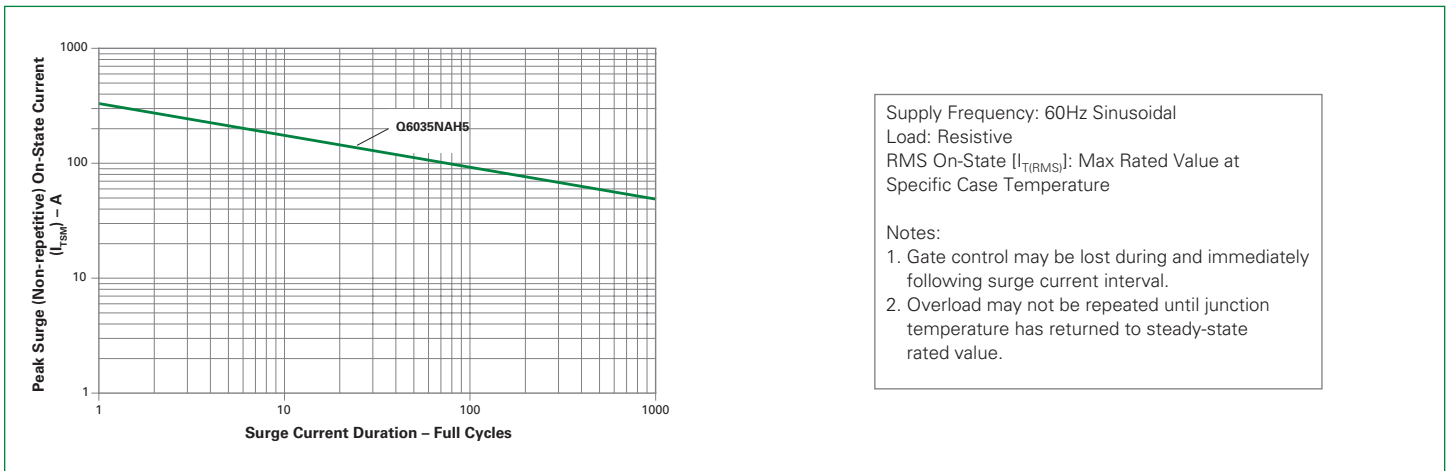
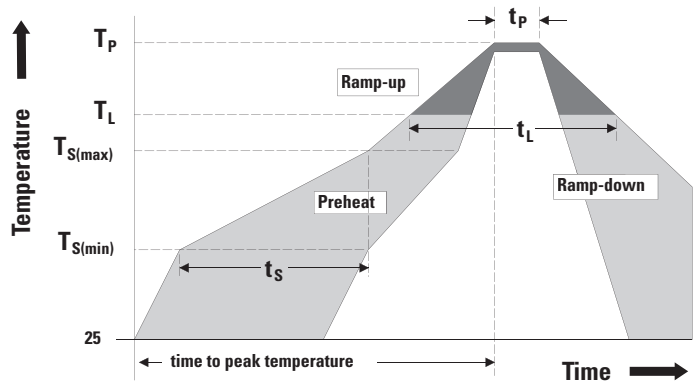

Fig. 8. Surge Peak On-state Current vs. Number of Cycles



Soldering Parameters

Characteristic		Value
Reflow Condition		Pb - Free assembly
Pre-heat	Temperature Min (T _{s(min)})	150°C
	Temperature Max (T _{s(max)})	200°C
	Time (min to max) (t _s)	60 - 180 secs
Average ramp up rate (Liquidus Temp)(T _L) to peak		5°C/second max
T _{S(max)} to T _L - Ramp-up Rate		5°C/second max
Reflow	Temperature (T _L) (Liquidus)	217°C
	Time (t _L)	60 - 150 seconds
Peak Temperature (T _p)		260 ^{+0/-5} °C
Time within 5°C of actual peak Temperature (t _p)		20 - 40 seconds
Ramp-down Rate		5°C/second max
Time 25°C to peak Temperature (T _p)		8 minutes max
Do Not Exceed		280°C



Physical Specifications

Characteristic	Value
Terminal Finish	100% Matte Tin-plated
Body Material	UL Recognized compound meeting flammability rating V-0
Terminal Material	Copper Alloy

Design Considerations

Careful selection of the correct component for the application's operating parameters and environment will go a long way toward extending the operating life of the Thyristor. Good design practice should limit the maximum continuous current through the main terminals to 75% of the component rating. Other ways to ensure long life for a power discrete semiconductor are proper heat sinking and selection of voltage ratings for worst case conditions. Overheating, overvoltage (including dv/dt), and surge currents are the main killers of semiconductors. Correct mounting, soldering, and forming of the leads also help protect against component damage.

Environmental Specifications

Test	Specifications and Conditions
AC Blocking	MIL-STD-750, M-1040, Cond A Applied Peak AC voltage @ 125°C for 1008 hours
Temperature/Humidity	EIA / JEDEC, JESD22-A101, 1008 hours; 160V - DC: 85°C; 85% relative humidity
Temperature Cycling	MIL-STD-750, M-1051, 1000 cycles; -55°C to +150°C; 15-min dwell-time
Resistance to Solder Heat	MIL-STD-750: Method 2031
Solderability	ANSI/J-STD-002: category 3, Test A
Lead Bend	MIL-STD-750, M-2036 Cond E
Moisture Sensitivity Level	Level 1, JEDEC-J-STD-020
UFAST	JESD22A-118, 96 hrs, 130°C/ 85% RH

Package Dimensions TO-263 (N-Package) – D²PAK Surface Mount

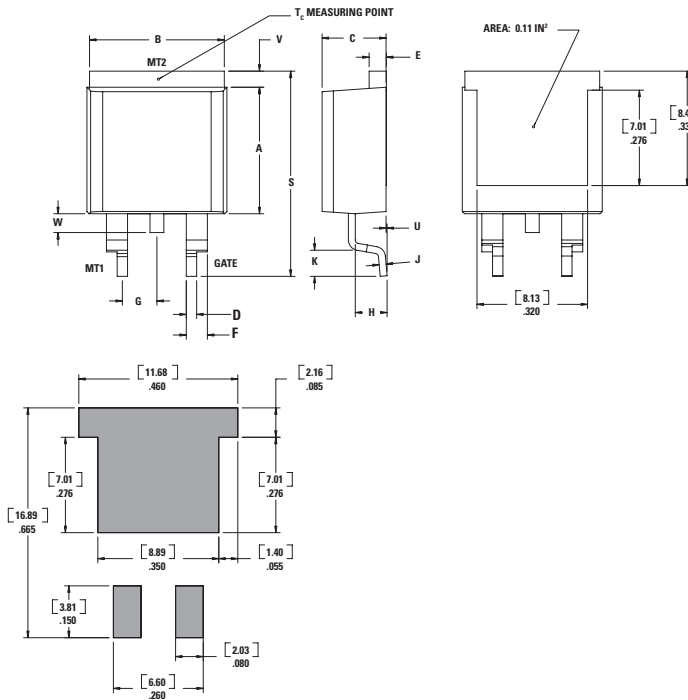

Symbol	Millimeters		Inches	
	Min.	Max.	Min.	Max.
A	9.14	9.40	0.360	0.370
B	9.65	10.67	0.380	0.420
C	4.52	4.78	0.178	0.188
D	0.64	0.89	0.025	0.035
E	1.14	1.52	0.045	0.060
F	1.52	1.91	0.060	0.075
G	2.41	2.67	0.095	0.105
H	2.34	2.59	0.092	0.102
J	0.46	0.61	0.018	0.024
K	2.29	2.79	0.090	0.110
S	14.99	15.88	0.590	0.625
V	0.89	1.14	0.035	0.045
U	0.05	0.25	0.002	0.010
W	1.016	1.78	0.040	0.070

Product Selector

Part Number	Voltage	Gate Sensitivity Quadrants	Type	Package
	600 V	I – II – III		
Q6035NAH5	X	50 mA	Alternistor TRIAC	TO-263 D ² PAK

Packing Options

Part Number	Marking	Weight	Packing Mode	Base Quantity
Q6035NAH5RP	Q6035NAH5	1.60 g	Embossed Carrier	500

Part Numbering and Marking

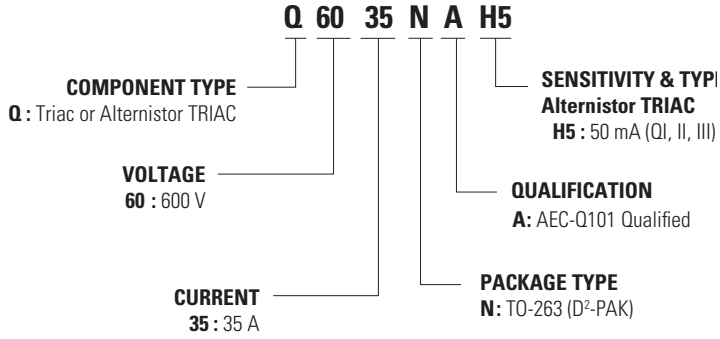

TO-263AB (N-Package)

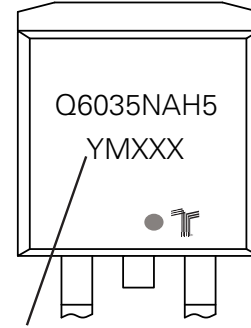

Date Code Marking
Y: Year Code
M: Month Code
XXX: Lot Trace Code

Carrier Tape Specification (TO-263 Embossed Carrier Reel Pack)

Meets all EIA-481-2 Standards

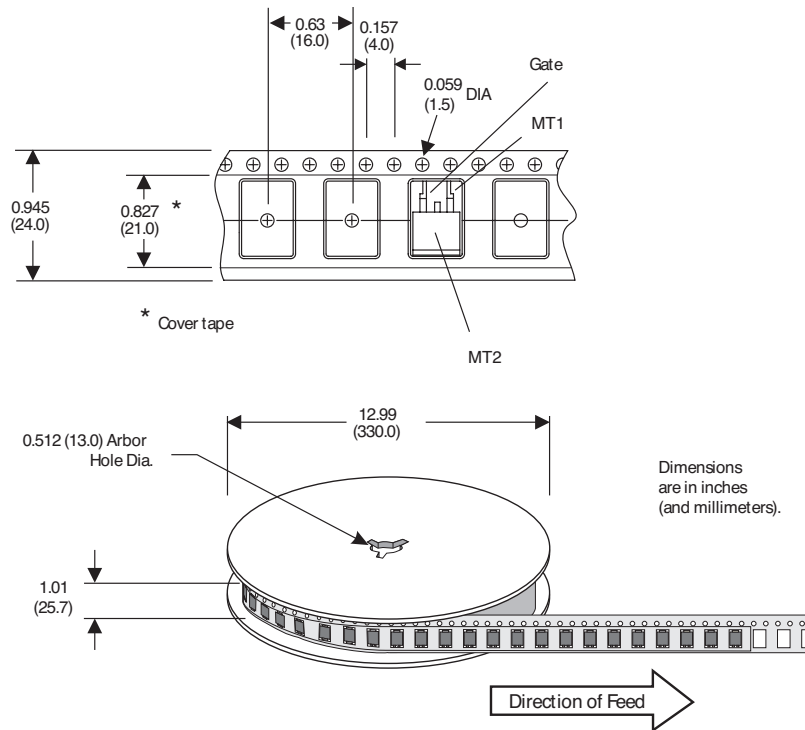

Disclaimer Notice

Information furnished is believed to be accurate and reliable. However, users should independently evaluate the suitability of and test each product selected for their own applications. Littelfuse products are not designed for, and may not be used in, all applications. Read complete Disclaimer Notice at <http://www.littelfuse.com/disclaimer-electronics>.



Part of:

