

QJxx40xx Series

40 A Alternistor High Temperature Alternistor Triacs

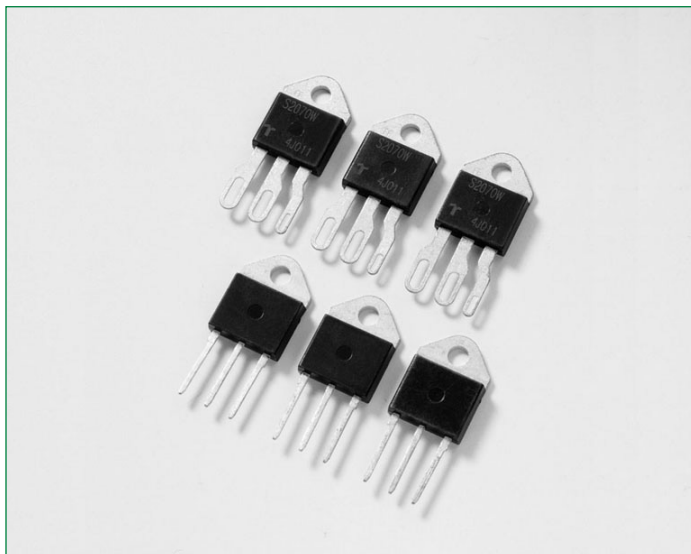

E71639 (K and J Packages)



Description:

The 40 Amp bi-directional solid state switch series is designed for AC switching and phase control applications such as motor speed, temperature modulation controls, lighting controls, and static switching relays.

Alternistor type components only operate in quadrants I, II, & III and are used in circuits requiring high dv/dt capability.

Standard type devices operate in quadrants I,II,III & IV.

Features:

- RoHS compliant
- High T_J of 150°C
- Voltage capability up to 800 V
- Surge capability up to 500 A
- Electrically isolated for 2500 V_{RMS}
- Recognized to UL 1557 as an Electrically Isolated Semiconductor Device

Schematic Symbol

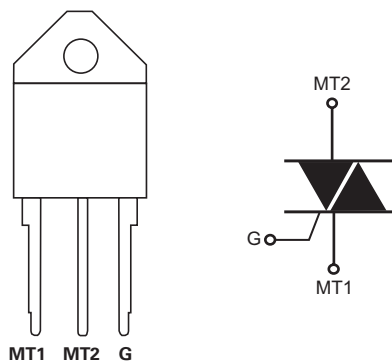

MT1: Main Terminal 1; **MT2:** Main Terminal 2; **G:** Gate

Applications:

Excellent for AC switching and phase control applications such as heating, lighting, and motor speed controls.

Typical applications are AC solid-state switches, industrial power tools, exercise equipment, white goods and commercial appliances.

Alternistor Triacs (no snubber required) are used in applications with extremely inductive loads requiring highest commutation performance.

Internally constructed isolated packages are offered for ease of heat sinking with highest isolation voltage.

Product Summary

Characteristic	Value	Unit
$I_{T(RMS)}$	40	A
V_{DRM}/V_{RRM}	400 to 800	V
$I_{GT(Q1)}$	35 to 100	mA

Absolute Maximum Ratings - Alternistor Triac (3 Quadrants)

Symbol	Characteristics	Conditions	Value	Units	
$I_{T(RMS)}$	On-state RMS Current (Full Sine Wave)	QJxx40xH5	$T_C = 100^\circ\text{C}$	40	A
		QJxx40xH6			
		QJxx40xH7			
I_{TSM}	Non-repetitive Surge Peak On-state Current (Full cycle, T_J initial = 25°C)	$f = 50\text{ Hz}$, $t = 20\text{ ms}$	420	A	
		$f = 60\text{ Hz}$, $t = 16.7\text{ ms}$	500		
I^2T	I^2T Value for Fusing	$t_p = 8.3\text{ ms}$	1037	A^2s	
di/dt	Critical Rate of Rise of On-state Current ($I_G = 2 \times I_{GT}$, $tr \leq 100\text{ ns}$)	$f = 120\text{ Hz}$, $T_J = 150^\circ\text{C}$	150	$\text{A}/\mu\text{s}$	
I_{GTM}	Peak Gate Trigger Current	$t_p = 20\text{ }\mu\text{s}$, $T_J = 150^\circ\text{C}$	4	A	
$P_{G(AV)}$	Average Gate Power Dissipation	$T_J = 150^\circ\text{C}$	0.5	W	
T_{stg}	Storage Temperature Range	–	–40 to 150	$^\circ\text{C}$	
T_J	Operating Junction Temperature Range	–	–40 to 150	$^\circ\text{C}$	
V_{DSM}/V_{RSM}	Non-repetitive Peak Blocking Voltage	400 – 600 V	$V_{DRM}/V_{RRM} + 100$	V	
		800 V	$V_{DRM}/V_{RRM} + 200$		

Absolute Maximum Ratings - Standard Triac (3 Quadrants)

Symbol	Characteristics	Conditions	Value	Units	
$I_{T(RMS)}$	On-state RMS Current	QJxx40x3	$T_C = 100^\circ\text{C}$	40	A
		QJxx40x4			
I_{TSM}	Peak Non-repetitive Surge Current	$f = 50\text{ Hz}$, $t = 20\text{ ms}$	420	A	
		$f = 60\text{ Hz}$, $t = 16\text{ ms}$	500		
I^2T	I^2T Value for Fusing	$t_p = 8.3\text{ ms}$	1037	A^2s	
di/dt	Critical Rate of Rise of On-state Current	$f = 120\text{ Hz}$, $T_J = 150^\circ\text{C}$	150	$\text{A}/\mu\text{s}$	
I_{GTM}	Peak Gate Current	$t_p = 20\text{ }\mu\text{s}$, $T_J = 150^\circ\text{C}$	4	A	
$P_{G(AV)}$	Average Gate Power Dissipation	$T_J = 150^\circ\text{C}$	0.5	W	
T_{stg}	Storage Temperature Range	–	–40 to 150	$^\circ\text{C}$	
T_J	Operating Junction Temperature Range	–	–40 to 150	$^\circ\text{C}$	

Electrical Characteristics ($T_J = 25^\circ\text{C}$, unless otherwise specified) — **Alternistor Triac** (3 Quadrants)

Symbol	Characteristics	Conditions	Quadrant		Value			Units
					QJxx40xH6	QJxx40xH5	QJxx40xH7	
I_{GT}	DC Gate Trigger Current	$V_D = 12\text{V}$, $R_L = 60\Omega$	I – II – II	Max.	80	50	100	mA
V_{GT}	DC Gate Trigger Voltage	$V_D = 12\text{V}$, $R_L = 60\Omega$	I – II – II	Max.	1.3	1.3	1.3	V
V_{GD}	Gate Non-trigger Voltage	$V_D = V_{DRM}$, $R_L = 3.3\text{k}\Omega$, $T_J = 150^\circ\text{C}$	I – II – II	Min.	0.2			V
I_H	Holding Current	$I_T = 400\text{ mA}$	–	Max.	80	75	100	mA
dv/dt	Critical Rate-of-rise of Off-stage Voltage	$V_D = V_{DRM}$, Gate Open, $T_J = 150^\circ\text{C}$	400 V	Min.	1800	1300	2500	V/ μs
			600 V		1600	1200	2200	
			800 V		1500	1000	2000	
(dv/dt)c	Critical Rate-of-rise of Commutation Voltage	(di/dt)c = 21.6 A/ms, $T_J = 150^\circ\text{C}$		Min.	30	20	40	V/ μs
t_{gt}	Turn-on Time	$I_G = 2 \times I_{GT}$, $P_W = 15\ \mu\text{s}$, $I_T = 56.6\text{A}_{(pk)}$		Typ.	5			μs

Electrical Characteristics ($T_J = 25^\circ\text{C}$, unless otherwise specified) — **Standard Triac** (4 Quadrants)

Symbol	Characteristics	Conditions	Quadrant		Value		Units
					QJxx40x3	QJxx40x4	
I_{GT}	DC Gate Trigger Current	$V_D = 12\text{V}$, $R_L = 60\Omega$	I – II – II	Max.	35	50	mA
			IV	Max.	70	100	
V_{GT}	DC Gate Trigger Voltage	$V_D = 12\text{V}$, $R_L = 60\Omega$	All	Max.	1.3		V
V_{GD}	Gate Non-trigger Voltage	$V_D = V_{DRM}$, $R_L = 3.3\text{k}\Omega$, $T_J = 150^\circ\text{C}$	All	Min.	0.2		V
I_H	Holding Current	$I_T = 400\text{ mA}$ (initial)	–	Max.	60	80	mA
dv/dt	Critical Rate-of-rise of Off-stage Voltage	$V_D = V_{DRM}$, Gate Open, $T_J = 150^\circ\text{C}$	400 V	Min.	800	1500	V/ μs
			600 V		600	1200	
			800 V		500	1000	
(dv/dt)c	Critical Rate-of-rise of Commutation Voltage	(di/dt)c = 21.6 A/ms, $T_J = 150^\circ\text{C}$		Min.	10		V/ μs
t_{gt}	Turn-on Time	$I_G = 2 \times I_{GT}$, $P_W = 15\ \mu\text{s}$, $I_T = 35.4\text{A}$		Typ.	5		μs

Static Characteristics

Symbol	Characteristics	Conditions	Maximum Value	Units
V_{TM}	Peak On-state Voltage	$I_{TM} = 56.6\text{A}$, $t_p = 380\ \mu\text{s}$	1.6	V
I_{DRM}/I_{RRM}	Off-state Current, Peak Repetitive	$V_D = V_{DRM}/V_{RRM}$, $T_J = 25^\circ\text{C}$	400 – 800 V	20 μA
		$V_D = V_{DRM}/V_{RRM}$, $T_J = 125^\circ\text{C}$	400 – 800 V	2 mA
		$V_D = V_{DRM}/V_{RRM}$, $T_J = 150^\circ\text{C}$	800 V	6 mA

Thermal Characteristics

Symbol	Characteristics	Value	Units	
$R_{th(JC)}$	Thermal Resistance, Junction to Case (AC)	QJxx40KH6 QJxx40KH5/H7 QJxx40K3 QJxx40K4/J4	1.6	$^\circ\text{C}/\text{W}$
		QJxx40JH5 QJxx40JH6 QJxx40JH7	1.5	

Characteristic Curves

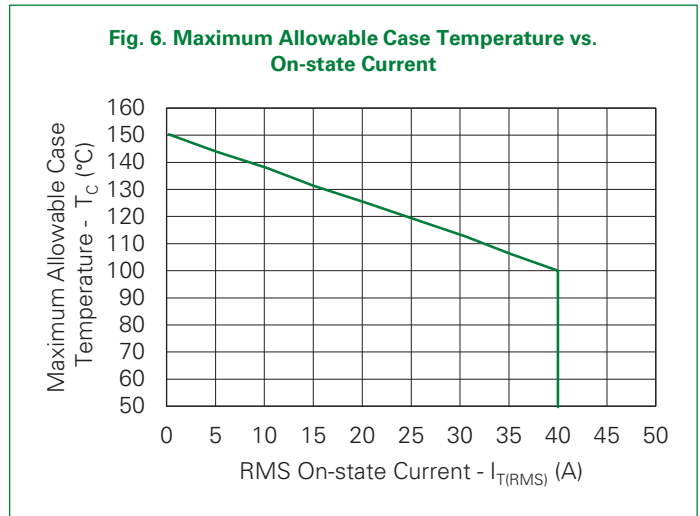
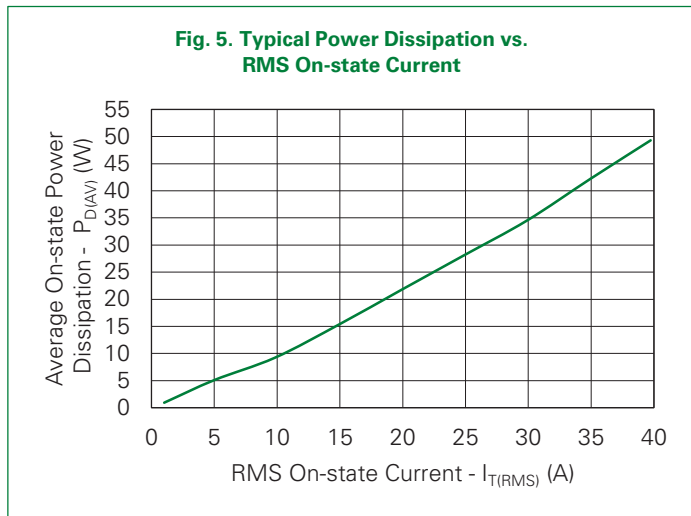
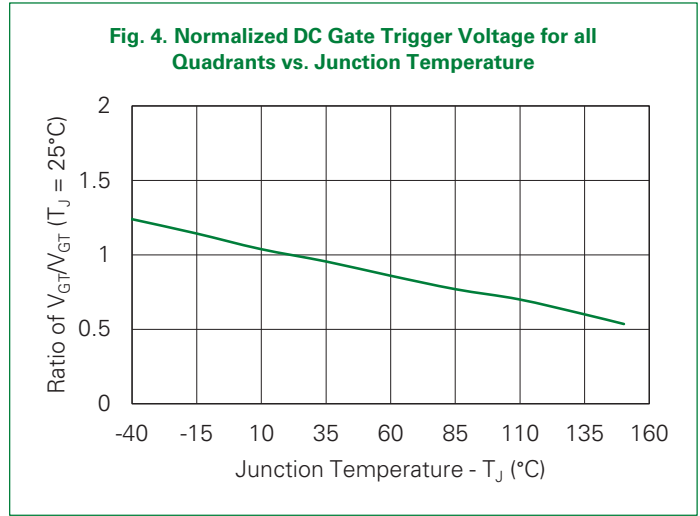
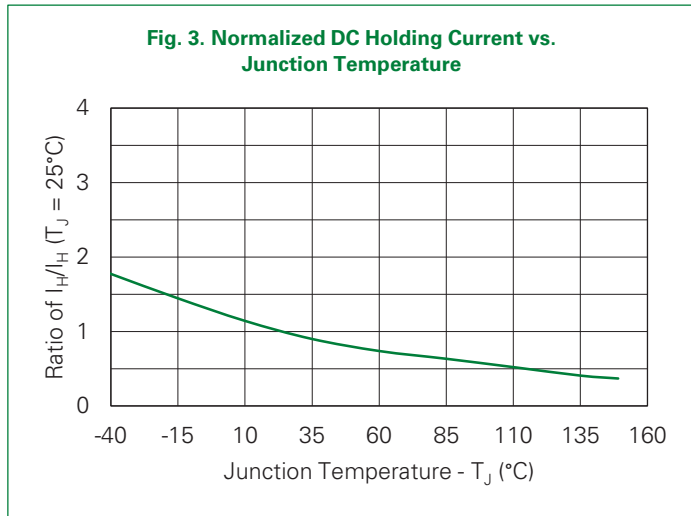
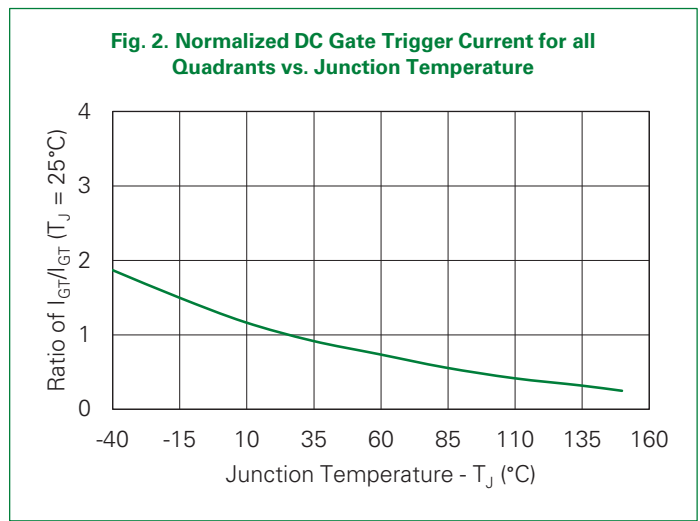
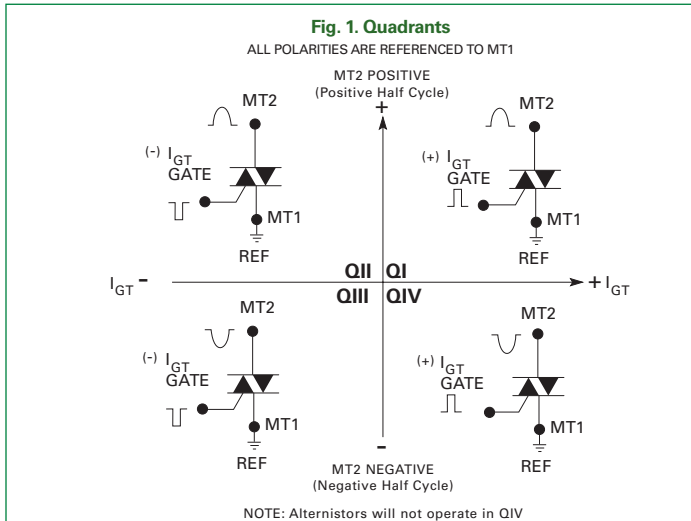

Fig. 7. Typical On-state Current vs. On-state Voltage

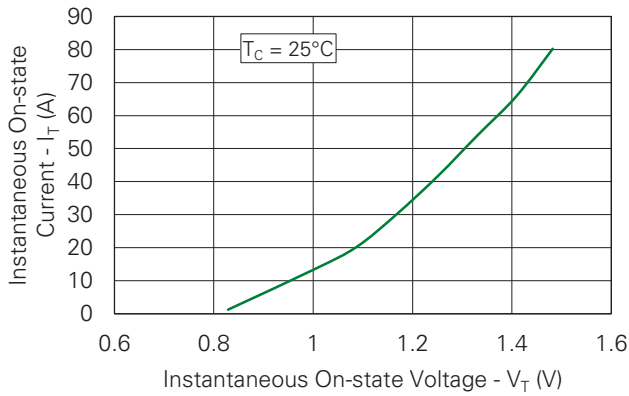
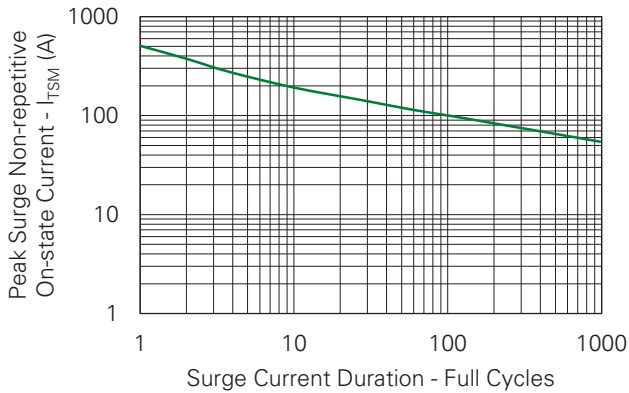

Fig. 8. Surge Peak On-state Current vs. Number of Cycles



SUPPLY FREQUENCY: 60 Hz Sinusoidal
 LOAD: Resistive
 RMS On-State Current: [$I_{T(RMS)}$]: Maximum Rated Value at Specified Case Temperature

- Notes:
1. Gate control may be lost during and immediately following surge current interval.
 2. Overload may not be repeated until junction temperature has returned to steady-state rated value.

Soldering Parameters

Characteristic		Value
Reflow Condition		Pb – Free assembly
Pre-heat	Temperature Min ($T_{s(min)}$)	150°C
	Temperature Max ($T_{s(max)}$)	200°C
	Time (min to max) (t_s)	60 – 180 secs
Average ramp up rate (Liquidus Temp)(T_L) to peak		5°C/second max
$T_{s(max)}$ to T_L - Ramp-up Rate		5°C/second max
Reflow	Temperature (T_L) (Liquidus)	217°C
	Time (t_L)	60 – 150 seconds
Peak Temperature (T_p)		260 ^{+0/-5} °C
Time within 5°C of actual peak Temperature (t_p)		20 – 40 seconds
Ramp-down Rate		5°C/second max
Time 25°C to peak Temperature (T_p)		8 minutes max
Do Not Exceed		280°C

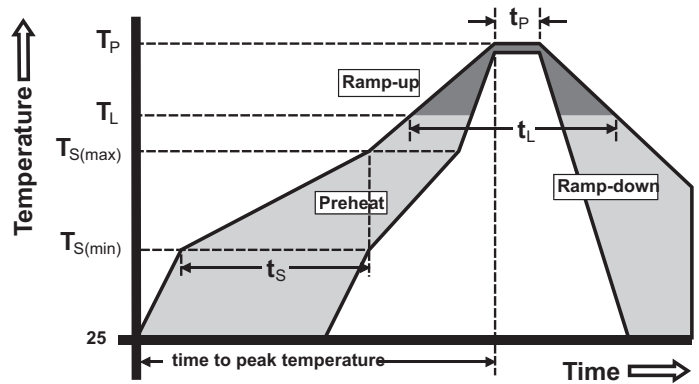

Physical Specifications

Characteristic	Value
Terminal Finish	100% Matte Tin-plated
Body Material	UL Recognized compound meeting flammability rating V-0
Terminal Material	Copper Alloy

Design Considerations

Careful selection of the correct component for the application's operating parameters and environment will go a long way toward extending the operating life of the Thyristor. Good design practice should limit the maximum continuous current through the main terminals to 75% of the component rating. Other ways to ensure long life for a power discrete semiconductor are proper heat sinking and selection of voltage ratings for worst case conditions. Overheating, overvoltage (including dv/dt), and surge currents are the main killers of semiconductors. Correct mounting, soldering, and forming of the leads also help protect against component damage.

Environmental Specifications

Test	Specifications and Conditions
AC Blocking	MIL-STD-750, M-1040, Cond A Applied Peak AC voltage @ 125°C for 1008 hours
Temperature/Humidity	EIA / JEDEC, JESD22-A101, 1008 hours; 320V - DC: 85°C; 85% relative humidity
Temperature Cycling	MIL-STD-750, M-1051, 100 cycles; -40°C to +150°C; 15-min dwell-time
High Temp Storage	MIL-STD-750, M-1031, 1008 hours; 150°C
Low Temp Storage	1008 hours; -40°C
Resistance to Solder Heat	MIL-STD-750: Method 2031
Solderability	ANSI/J-STD-002: category 3, Test A
Lead Bend	MIL-STD-750, M-2036 Cond E

Package Dimensions TO-218X (J-Package) – Isolated Mounting Tab

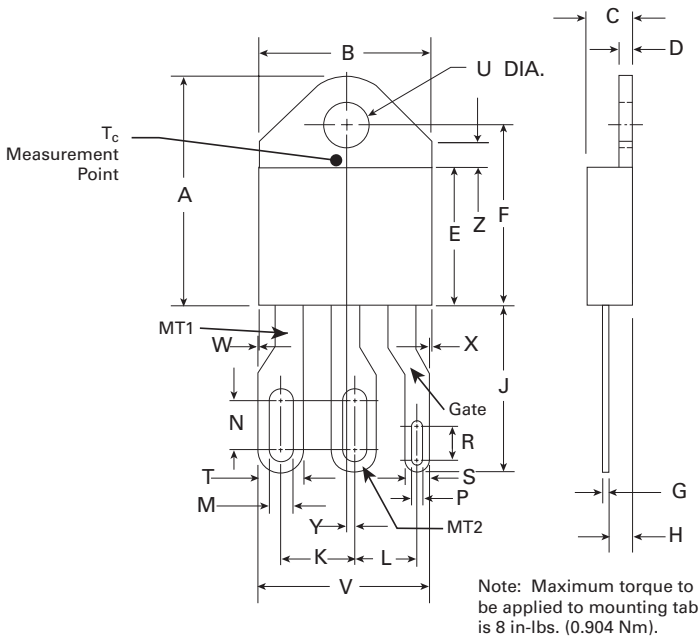

Symbol	Millimeters		Inches	
	Min.	Max.	Min.	Max
A	20.57	21.21	0.810	0.835
B	15.49	16.00	0.610	0.630
C	4.52	4.78	0.178	0.188
D	1.40	1.78	0.055	0.070
E	12.37	12.62	0.487	0.497
F	16.13	16.64	0.635	0.655
G	0.56	0.74	0.022	0.029
H	1.91	2.41	0.075	0.095
J	14.61	15.88	0.575	0.625
K	6.50	6.71	0.256	0.264
L	5.58	5.79	0.220	0.228
M	2.03	2.24	0.080	0.088
N	4.29	4.49	0.169	0.177
P	0.86	1.07	0.034	0.042
R	2.87	3.07	0.113	0.121
S	2.18	2.44	0.086	0.096
T	3.96	4.22	0.156	0.166
U	4.10	4.20	0.161	0.165
V	15.31	15.70	0.603	0.618
W	0.00	0.13	0.000	0.005
X	0.07	0.30	0.003	0.012
Y	0.71	0.81	0.028	0.032
Z	2.17	2.42	0.085	0.095

Package Dimensions TO-218AC (K-Package) – Isolated Mounting Tab

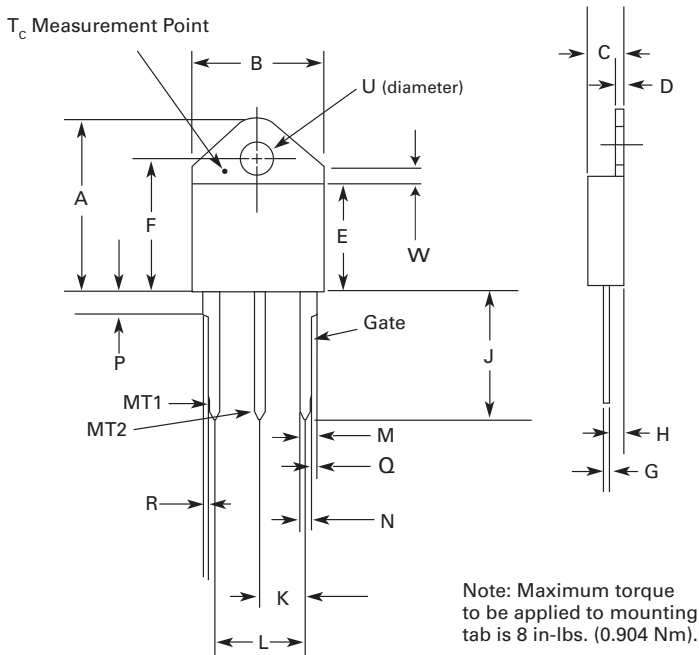

Symbol	Millimeters		Inches	
	Min.	Max.	Min.	Max.
A	20.57	21.21	0.810	0.835
B	15.49	16.00	0.610	0.630
C	4.52	4.78	0.178	0.188
D	1.40	1.78	0.055	0.070
E	12.37	12.62	0.487	0.497
F	16.13	16.64	0.635	0.655
G	0.56	0.74	0.022	0.029
H	1.91	2.41	0.075	0.095
J	14.61	15.88	0.575	0.625
K	5.36	5.56	0.211	0.219
L	10.72	11.10	0.422	0.437
M	1.47	1.73	0.058	0.068
N	1.14	1.40	0.045	0.055
P	2.41	2.92	0.095	0.115
Q	0.20	0.41	0.008	0.016
R	0.20	0.41	0.008	0.016
U	4.10	4.20	0.161	0.165
W	2.17	2.42	0.085	0.095

Product Selector

Part Number	Voltage			Gate Sensitivity Quadrants		$I_{T(RMS)}$	Type	Package
	400 V	600 V	800 V	I – II – III	IV			
QJxx40KH6	X	X	X	80 mA	–	40 A	Alternistor Triac	TO-218AC
QJxx40JH6	X	X	X	80 mA	–	40 A	Alternistor Triac	TO-218X
QJxx40KH5	X	X	X	50 mA	–	40 A	Alternistor Triac	TO-218AC
QJxx40JH5	X	X	X	50 mA	–	40 A	Alternistor Triac	TO-218X
QJxx40KH7	X	X	X	100 mA	–	40 A	Alternistor Triac	TO-218AC
QJxx40JH7	X	X	X	100 mA	–	40 A	Alternistor Triac	TO-218X
QJxx40K3	X	X	X	35 mA	70 mA	40 A	Standard Triac	TO-218AC
QJxx40K4	X	X	X	50 mA	100 mA	40 A	Standard Triac	TO-218AC

Note: xx = Voltage

Packing Options

Part Number	Marking	Weight	Packing Mode	Base Quantity
QJxx40KH6TP	QJxx40KH6	4.40 g	Tube Pack	250 (25 per tube)
QJxx40JH6TP	QJxx40JH6	5.23 g	Tube Pack	250 (25 per tube)
QJxx40KH5TP	QJxx40KH5	4.40 g	Tube Pack	250 (25 per tube)
QJxx40JH5TP	QJxx40JH5	5.23 g	Tube Pack	250 (25 per tube)
QJxx40KH7TP	QJxx40KH7	4.40 g	Tube Pack	250 (25 per tube)
QJxx40JH7TP	QJxx40JH7	5.23 g	Tube Pack	250 (25 per tube)
QJxx40K3TP	QJxx40K3	4.40 g	Tube Pack	250 (25 per tube)
QJxx40K4TP	QJxx40K4	4.40 g	Tube Pack	250 (25 per tube)

Note: xx = Voltage

Part Numbering and Marking

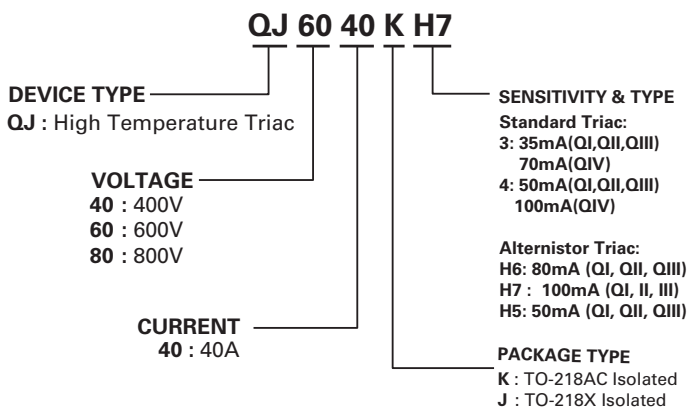

TO-218 AC - (K Package)
 TO-218 X - (J Package)

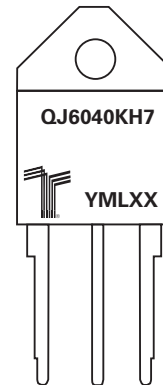

Disclaimer Notice

Information furnished is believed to be accurate and reliable. However, users should independently evaluate the suitability of and test each product selected for their own applications. Littelfuse products are not designed for, and may not be used in, all applications. Read complete Disclaimer Notice at <http://www.littelfuse.com/disclaimer-electronics>.



Part of:

