

S8016xA Series

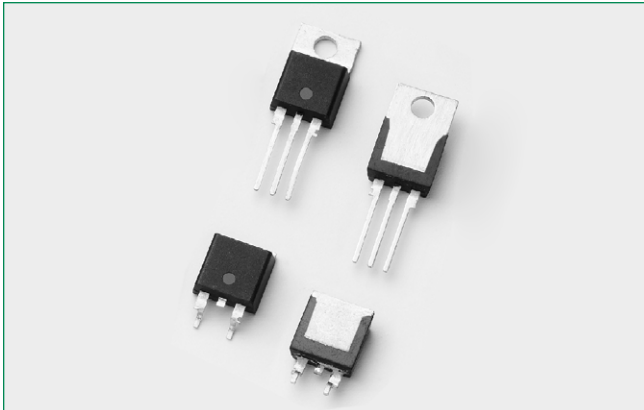

Main Features

Symbol	Value	Unit
$I_{T(RMS)}$	16	A
V_{DRM}/V_{RRM}	800	V
I_{GT}	50	mA

Schematic Symbol

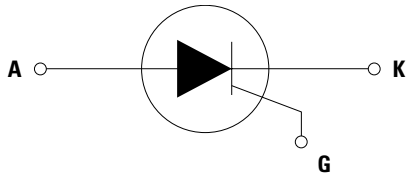

Description

The Littelfuse SCR S8016xA series are specifically designed for Electric Vehicle On-Board Charger (EVOBC) applications. This SCR AC line input rectifier can handle Level 1 charging up to 16Arms at 120V, and Level 2 charging up to 16A rms at 240V at 100°C and up to 25A rms for 80°C. Its excellent AC handling capability and surge robustness makes this series an ideal switch for these input rectifiers.

Features & Benefits

- V_{DRM} 800V, I_T 25rms to handle input from 100-250V line AC
- High di/dt of 375/ μ sec enables handling of 3kA 8/20 surge current operationally
- High V_{DSM}/V_{RSM} of 1300V, high dv/dt of 2000V/ μ sec prevents SCR mis-triggering during 6kV 1.2/50-8/20 surge event with minimal over voltage protection or snubber circuit
- Available in the compact TO-263 SMT package
- AEC-Q101 Qualified
- Halogen free and RoHS compliant

Applications

Input rectification of AC line input for EVOBC applications.

Absolute Maximum Ratings

Symbol	Parameter	Test Conditions	Value	Unit
V_{DSM}/V_{RSM}	Peak non-repetitive blocking voltage	Pw=100 μ s	1300	V
$I_{T(RMS)}$	RMS on-state current	$T_c=100^\circ\text{C}$	16	A
		$T_c=80^\circ\text{C}$	25	
$I_{T(AV)}$	Average on-state current	$T_c=100^\circ\text{C}$	10	A
		$T_c=80^\circ\text{C}$	16	
I_{TSM}	Peak non-repetitive surge current	single half cycle; f=50Hz; T_j (initial)=25°C	188	A
		single half cycle; f=60Hz; T_j (initial)=25°C	225	
I^2t	I^2t Value for fusing	$t_p=8.3$ ms	210	A ² s
I_{PP}	Non-repetitive peak surge current	with Littelfuse MOV V20E420AUTO across line; $T_j=125^\circ\text{C}$, 11.2/50-8/20 combination wave, $I_1=1\text{A}$	2400	A
di/dt	Critical rate of rise of on-state current	$T_j=125^\circ\text{C}$	375	A/ μ s
I_{GM}	Peak gate current	$T_j=125^\circ\text{C}$	3.0	A
$P_{G(AV)}$	Average gate power dissipation	$T_j=125^\circ\text{C}$	0.6	W
T_{stg}	Storage temperature range		-40 to 150	°C
T_j	Operating junction temperature range		-40 to 125	°C

Electrical Characteristics ($T_J = 25^\circ\text{C}$, unless otherwise specified)

Symbol	Test Conditions		Value	Unit
I_{GT}	$V_D=12\text{V}; R_L=30\Omega$	MIN.	15	mA
		MAX.	50	
V_{GT}		MAX.	1.5	V
dv/dt	$V_D=V_{DRM}$; gate open; $T_J=125^\circ\text{C}$	MIN.	2000	V/ μs
	1.2/50 pulse wave, with 250V AC with Littelfuse MOV V20E420AUTO across	MIN.	5	KV/ μs
V_{GD}	$V_D=V_{DRM}$; $R_L=3.3\text{ k}\Omega$; $T_J=125^\circ\text{C}$	MIN.	0.2	V
I_H	$I_T=400\text{mA}$ (initial)	MAX.	150	mA
t_q	$I_T=0.5\text{A}$; $t_p=50\mu\text{s}$; dv/dt=5V/ μs ; di/dt=-30A/ μs	MAX.	35	μs
t_{gt}	$I_G=2 \times I_{GT}$; PW=15 μs ; $I_T=40\text{A}$	TYP.	2	μs

Static Characteristics

Symbol	Test Conditions		Value	Unit
V_{TM}	$I_T=32\text{A}$; $t_p=380\mu\text{s}$	MAX.	1.6	V
I_{DRM} / I_{RRM}	@ V_{DRM} / V_{RRM}	$T_J=25^\circ\text{C}$	20	μA
		$T_J=100^\circ\text{C}$	1000	
		$T_J=125^\circ\text{C}$	2000	

Thermal Resistances

Symbol	Parameter	Value	Unit
$R_{\theta(JC)}$	Junction to case (AC)	1.0	$^\circ\text{C}/\text{W}$

Figure 1: Normalized DC Gate Trigger Current vs. Junction Temperature

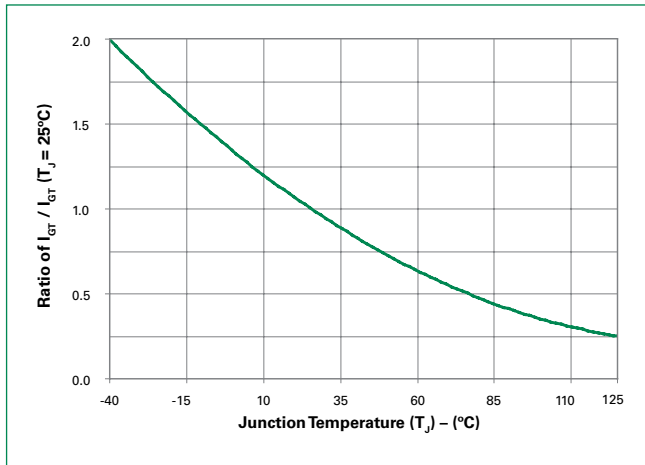

Figure 2: Normalized DC Gate Trigger Voltage vs. Junction Temperature

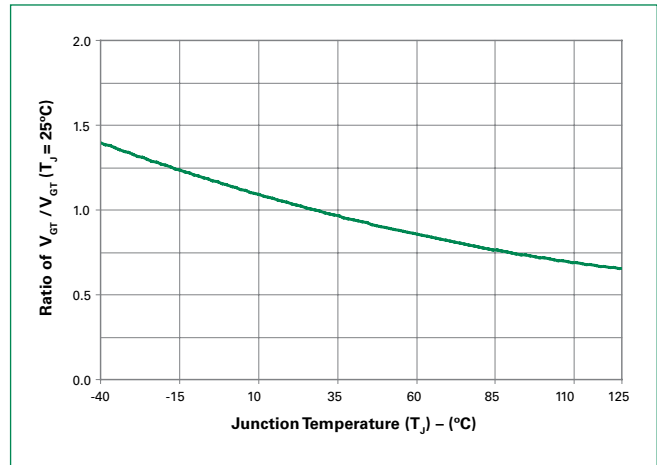

Figure 3: Normalized DC Holding Current vs. Junction Temperature

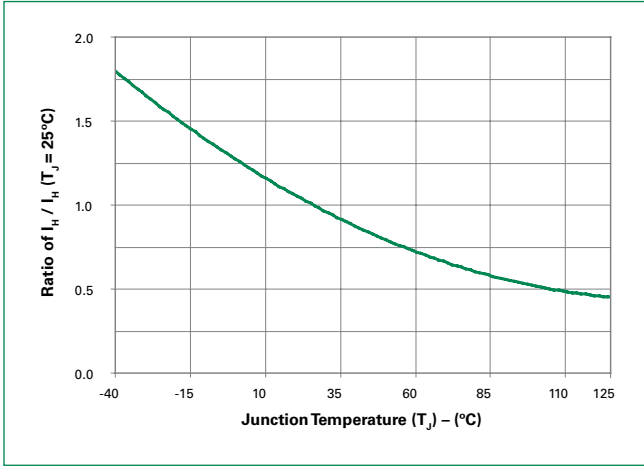

Figure 4: On-State Current vs. On-State Voltage (Typical)

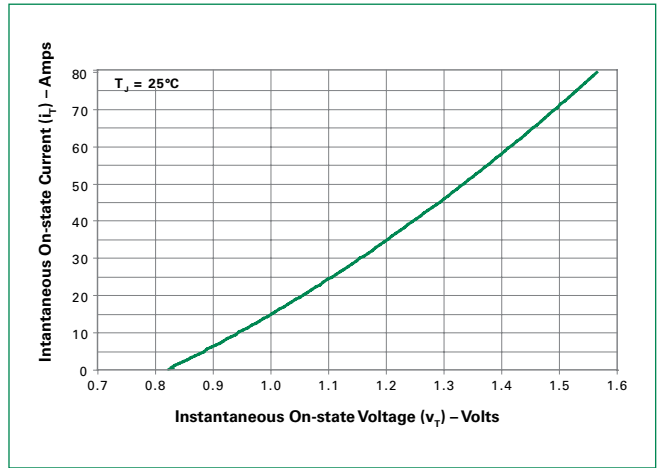

Figure 5: Power Dissipation (Typical) vs. RMS On-State Current

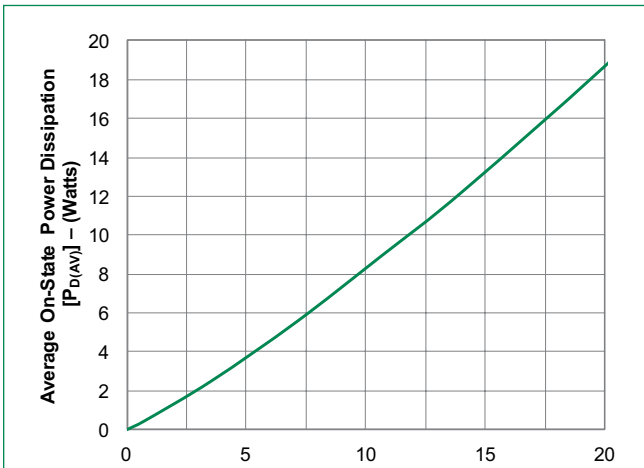

Figure 6: Maximum Allowable Case Temperature vs. RMS On-State Current

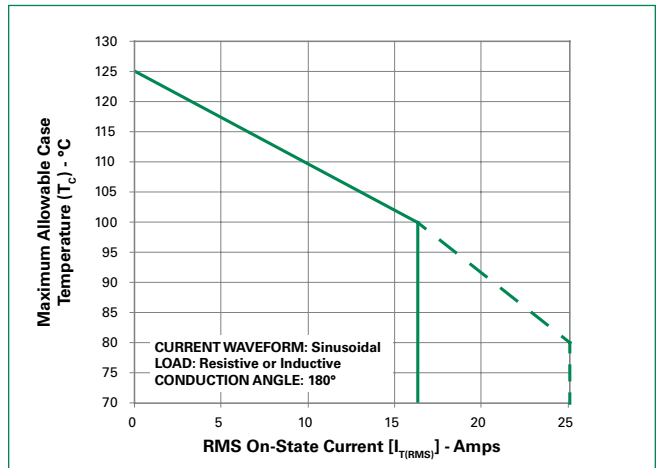

Figure 7: Maximum Allowable Case Temperature vs. Average On-State Current

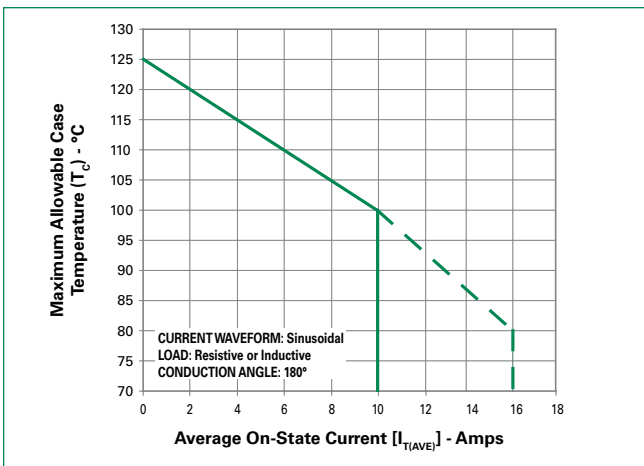
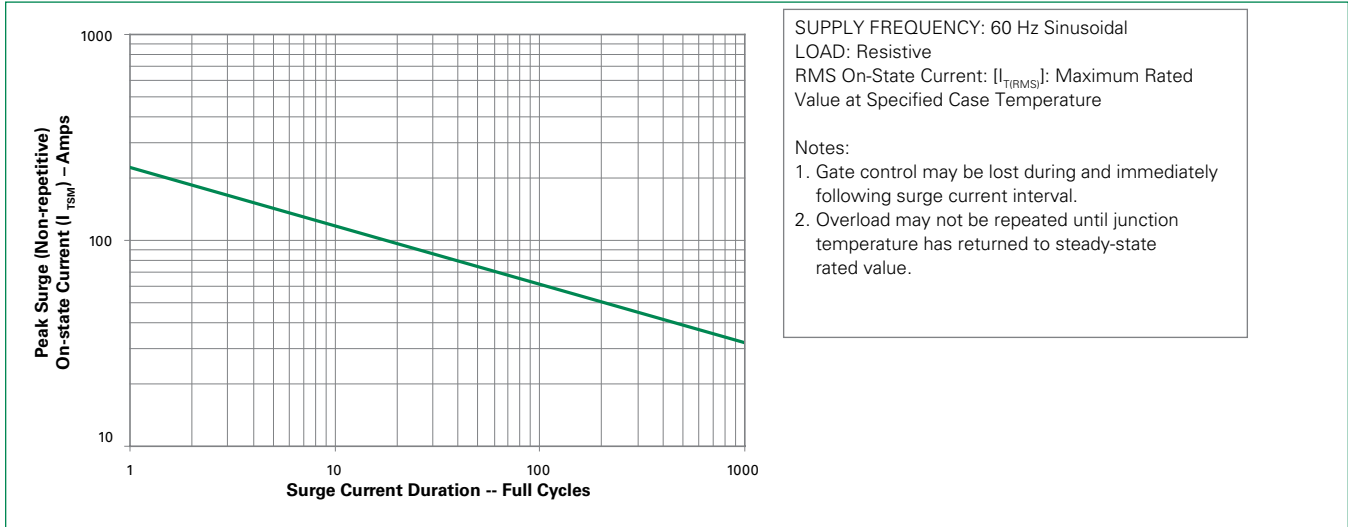
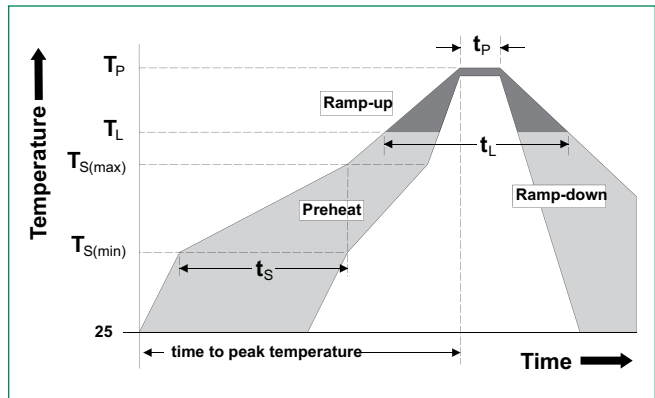

Figure 8: Surge Peak On-State Current vs. Number of Cycles



Soldering Parameters

Reflow Condition		Pb – Free assembly
Pre Heat	- Temperature Min ($T_{s(min)}$)	150°C
	- Temperature Max ($T_{s(max)}$)	200°C
	- Time (min to max) (t_s)	60 – 180 secs
Average ramp up rate (Liquidus Temp) (T_L) to peak		5°C/second max
$T_{S(max)}$ to T_L - Ramp-up Rate		5°C/second max
Reflow	- Temperature (T_L) (Liquidus)	217°C
	- Time (t_L)	60 – 150 seconds
Peak Temperature (T_p)		260 ^{+0/-5} °C
Time within 5°C of actual peak Temperature (t_p)		20 – 40 seconds
Ramp-down Rate		5°C/second max
Time 25°C to peak Temperature (T_p)		8 minutes Max.
Do not exceed		280°C



Physical Specifications

Terminal Finish	100% Matte Tin-plated
Body Material	UL recognized compound meeting flammability rating V-0.
Lead Material	Copper Alloy

Design Considerations

Careful selection of the correct component for the application's operating parameters and environment will go a long way toward extending the operating life of the Thyristor. Good design practice should limit the maximum continuous current through the main terminals to 75% of the component rating. Other ways to ensure long life for a power discrete semiconductor are proper heat sinking and selection of voltage ratings for worst case conditions. Overheating, overvoltage (including dv/dt), and surge currents are the main killers of semiconductors. Correct mounting, soldering, and forming of the leads also help protect against component damage.

Environmental Specifications

Test	Specifications and Conditions
AC Blocking	MIL-STD-750, M-1040, Cond A Applied Peak AC voltage @ 125°C for 1008 hours
Temperature Cycling	JESD22 A-104 Appendix 6 -55°C to 150°C, 15-minute dwell, 1000 cycles
Autoclave (Pressure Cooker Test)	EIA/JEDEC: JESD22-A102 121°C, 100%RH, 15psig, 96hours
Biased Temperature & Humidity	EIA / JEDEC, JESD22-A101, 1008 hours; 320V - DC: 85°C; 85% rel humidity
Intermittent Operational Life	T _A =25°C, ΔT _J ≥ 100°C, 1008hrs
Resistance to Solder Heat	JESD22 A-111: 260°C, 10 seconds
Solderability	ANSI/J-STD-002, category 3, Test A

Dimensions –TO- 263AB (N-package) – D²-Pak Surface Mount

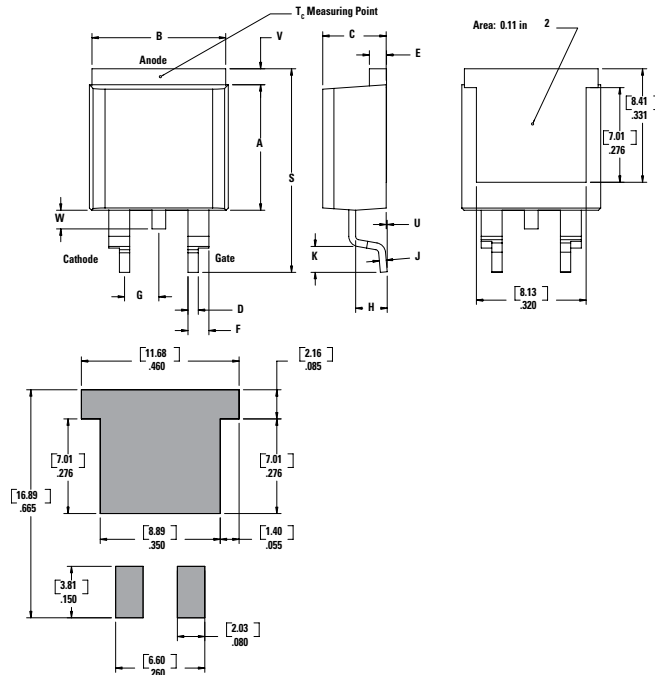

Dimension	Inches		Millimeters	
	Min	Max	Min	Max
A	0.360	0.370	9.14	9.40
B	0.380	0.420	9.65	10.67
C	0.178	0.188	4.52	4.78
D	0.025	0.035	0.64	0.89
E	0.045	0.060	1.14	1.52
F	0.060	0.075	1.52	1.91
G	0.095	0.105	2.41	2.67
H	0.092	0.102	2.34	2.59
J	0.018	0.024	0.46	0.61
K	0.090	0.110	2.29	2.79
S	0.590	0.625	14.99	15.88
V	0.035	0.045	0.89	1.14
U	0.002	0.010	0.05	0.25
W	0.040	0.070	1.016	1.78

Dimensions — TO-220AB (R-Package) — Non-Isolated Mounting Tab Common with Center Lead

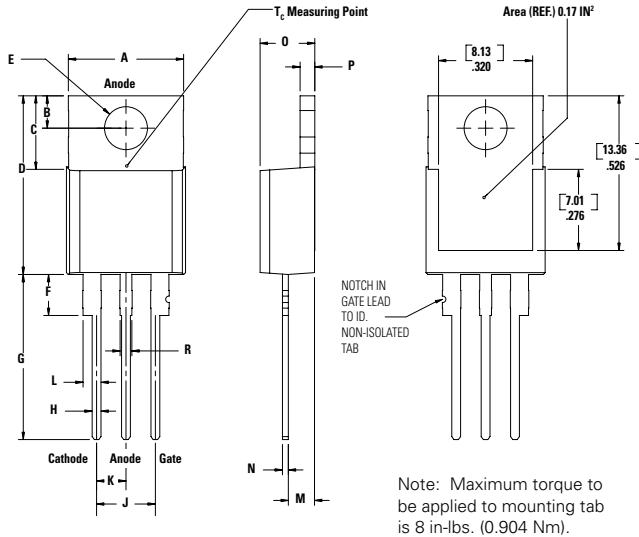

Dimension	Inches		Millimeters	
	Min	Max	Min	Max
A	0.380	0.420	9.65	10.67
B	0.105	0.115	2.67	2.92
C	0.230	0.250	5.84	6.35
D	0.590	0.620	14.99	15.75
E	0.142	0.147	3.61	3.73
F	0.110	0.130	2.79	3.30
G	0.540	0.575	13.72	14.61
H	0.025	0.035	0.64	0.89
J	0.195	0.205	4.95	5.21
K	0.095	0.105	2.41	2.67
L	0.060	0.075	1.52	1.91
M	0.085	0.095	2.16	2.41
N	0.018	0.024	0.46	0.61
O	0.178	0.188	4.52	4.78
P	0.045	0.060	1.14	1.52
R	0.038	0.048	0.97	1.22

Part Marking System

TO-220 AB - (R Package)
TO-263 (N Package)

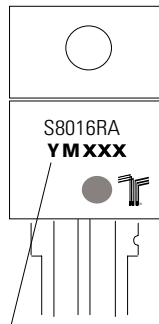

Date Code Marking
Y: Year Code
M: Month Code
XXX: Lot Trace Code

Part Numbering System

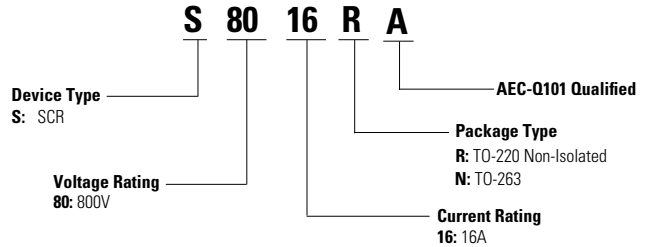

Packing Options

Part Number	Marking	Weight	Packing Mode	Base Quantity	Package
S8016RATP	S8016RA	1.6g	Tube	500 (50 per tube)	TO-220R
S8016NARP	S8016NA	1.6g	Embossed Carrier	500	TO-263

TO-263 Embossed Carrier Reel Pack (RP) Specifications

