

**T2500D**

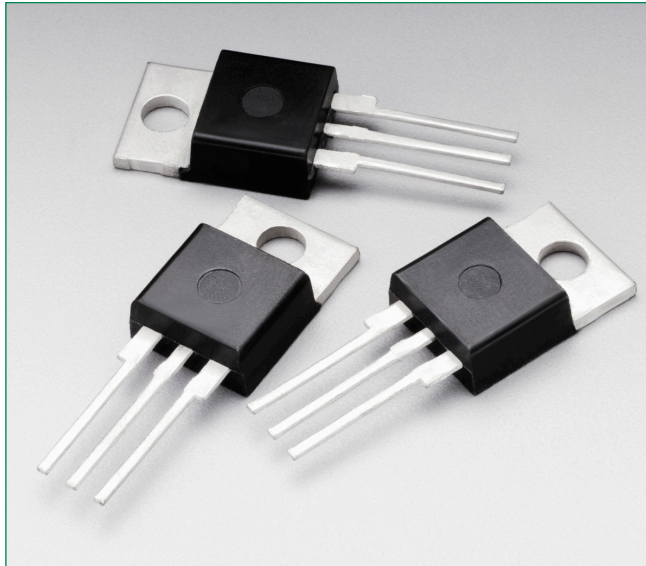

**Description**

Designed primarily for full-wave ac control applications, such as light dimmers, motor controls, heating controls and power supplies.

**Features**

- Blocking Voltage 400 V
- All Diffused and Glass Passivated Junctions for Greater Parameter Uniformity and Stability
- Small, Rugged, Thermowatt Construction for Low Thermal Resistance, High Heat Dissipation and Durability
- High Surge Current Capability 60 A Peak at  $T_c = 80^\circ\text{C}$
- Pb-Free Package is Available

**Pin Out**

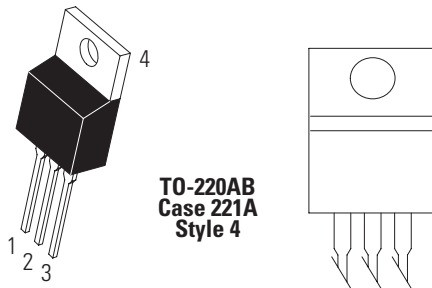

**Functional Diagram**

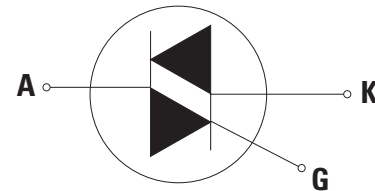

**Additional Information**



**Datasheet**



**Resources**



**Samples**

### Maximum Ratings ( $T_J = 25^\circ\text{C}$ unless otherwise noted)

| Rating   | Symbol                                 | Value       | Unit                 |
|--|--|-------------|----------------------|
| Peak Repetitive Off-State Voltage (Note 1)<br>(Sine Wave 50 to 60 Hz, $T_J = -40$ to $+100^\circ\text{C}$ , Gate Open) | $V_{\text{DRM}}^*$<br>$V_{\text{RRM}}$ | 400         | V                    |
| On-State RMS Current (Full Cycle Sine Wave 50 to 60 Hz) ( $T_C = +80^\circ\text{C}$ )                                  | $I_{\text{T (RMS)}}$                   | 6.0         | A                    |
| Peak Non-Repetitive Surge Current<br>(One Full Cycle, Sine Wave 60 Hz, $T_C = +80^\circ\text{C}$ )                     | $I_{\text{TSM}}$                       | 60          | A                    |
| Circuit Fusing Considerations ( $t = 8.3$ ms)  | $I^2t$                                 | 15          | $\text{A}^2\text{s}$ |
| Peak Gate Power (Pulse Width = 10 $\mu\text{sec}$ , $T_C = +80^\circ\text{C}$ )  | $P_{\text{GM}}$                        | 16          | W                    |
| Average Gate Power ( $t = 8.3$ msec, $T_C = +80^\circ\text{C}$ )   | $P_{\text{GM (AV)}}$                   | 0.2         | W                    |
| Peak Gate Current (Pulse Width = 10 $\mu\text{sec}$ )  | $I_{\text{GM}}$                        | 4.0         | A                    |
| Operating Junction Temperature Range   | $T_J$                                  | -40 to +125 | $^\circ\text{C}$     |
| Storage Temperature Range  | $T_{\text{stg}}$                       | -40 to +150 | $^\circ\text{C}$     |

### Thermal Characteristics

| Rating  | Symbol            | Value | Unit               |
|---|-------------------|-------|--------------------|
| Thermal Resistance, Junction-to-Case  | $R_{\text{thJC}}$ | 2.7   | $^\circ\text{C/W}$ |
| Maximum Lead Temperature for Soldering Purposes 1/8" from Case for 10 Seconds | $T_L$             | 260   | $^\circ\text{C}$   |

Stresses exceeding Maximum Ratings may damage the device. Maximum Ratings are stress ratings only. Functional operation above the Recommended Operating Conditions is not implied. Extended exposure to stresses above the Recommended Operating Conditions may affect device reliability.

- $V_{\text{DRM}}$  and  $V_{\text{RRM}}$  for all types can be applied on a continuous basis. Ratings apply for zero or negative gate voltage; however, positive gate voltage shall not be applied concurrent with negative potential on the anode. Blocking voltages shall not be tested with a constant current source such that the voltage ratings of the devices are exceeded.

### Electrical Characteristics - OFF ( $T_C = 25^\circ\text{C}$ unless otherwise noted)

| Characteristic  | Symbol                                 | Min                       | Typ | Max | Unit |               |
|---|--|---------------------------|-----|-----|------|---------------|
| †Peak Repetitive Blocking Current<br>( $V_{\text{AK}} = V_{\text{DRM}} = V_{\text{RRM}}$ ; Gate Open) | $I_{\text{DRM}}^*$<br>$I_{\text{RRM}}$ | $T_J = 25^\circ\text{C}$  | -   | -   | 10   | $\mu\text{A}$ |
|   |  | $T_J = 100^\circ\text{C}$ | -   | -   | 2.0  | mA            |

### Electrical Characteristics - ON ( $T_C = 25^\circ\text{C}$ unless otherwise noted; Electricals apply in both directions)

| Characteristic  | Symbol          | Min          | Typ  | Max | Unit          |    |
|---|-----------------|--------------|------|-----|---------------|----|
| Peak Forward On-State Voltage (Note 2) ( $I_{\text{TM}} = \pm 30$ A)  | $V_{\text{TM}}$ | -            | -    | 2.0 | V             |    |
| Gate Trigger Current (Continuous dc)<br>( $V_D = 12$ V, $R_L = 100$ $\Omega$ )  | $I_{\text{GT}}$ | MT2(+), G(+) | -    | 10  | 25            | mA |
|   |                 | MT2(+), G(-) | -    | 20  | 60            |    |
|   |                 | MT2(-), G(-) | -    | 15  | 25            |    |
|   |                 | MT2(-), G(+) | -    | 30  | 60            |    |
| Gate Trigger Voltage (Continuous dc) (All Four Quadrants)<br>( $V_D = 12$ Vdc, $R_L = 100$ $\Omega$ )                             | $V_{\text{GT}}$ | -            | 1.25 | 2.5 | V             |    |
| Gate Non-Trigger Voltage (Continuous dc)<br>( $V_D = 12$ Vdc, $R_L = 100$ $\Omega$ , $T_C = 100^\circ\text{C}$ )                  | $V_{\text{GD}}$ | 0.2          | -    | -   | V             |    |
| Holding Current<br>(Main Terminal Voltage = 12 Vdc, Gate Open, Initiating Current) = $\pm 200$ mA)                                | $I_{\text{H}}$  | -            | 15   | 30  | mA            |    |
| Gate Controlled Turn-On Time<br>(Rated $V_{\text{DRM}}$ , $I_T = 10$ A, $I_{\text{GT}} = 160$ mA, Rise Time = 0.1 $\mu\text{s}$ ) | $t_{\text{gt}}$ | -            | 1.6  | -   | $\mu\text{s}$ |    |

### Dynamic Characteristics

| Characteristic   | Symbol        | Min | Typ | Max | Unit                   |
|--|---------------|-----|-----|-----|------------------------|
| Critical Rate-of-Rise of Commutation Voltage<br>( $V_D = \text{Rated } V_{DRM}$ , $I_{T(RMS)} = 6 \text{ A}$ , Commutating $di/dt = 3.2 \text{ A/ms}$ , Gate Unenergized, $T_C = 80^\circ\text{C}$ ) | $dv/dt_{(c)}$ | –   | 10  | –   | $\text{V}/\mu\text{s}$ |
| Critical Rate-of-Rise of Off-State Voltage<br>( $V_D = \text{Rated } V_{DRM}$ , Exponential Voltage Rise, Gate Open, $T_C = 100^\circ\text{C}$ )   | $dv/dt$       | –   | 75  | –   | $\text{V}/\mu\text{s}$ |

2. Pulse Test: Pulse Width  $\leq 2.0 \text{ ms}$ , Duty Cycle  $\leq 2\%$ .

### Voltage Current Characteristic of SCR

| Symbol    | Parameter                                 |
|-----------|---|
| $V_{DRM}$ | Peak Repetitive Forward Off State Voltage |
| $I_{DRM}$ | Peak Forward Blocking Current             |
| $V_{RRM}$ | Peak Repetitive Reverse Off State Voltage |
| $I_{RRM}$ | Peak Reverse Blocking Current             |
| $V_{TM}$  | Maximum On State Voltage                  |
| $I_H$     | Holding Current                           |

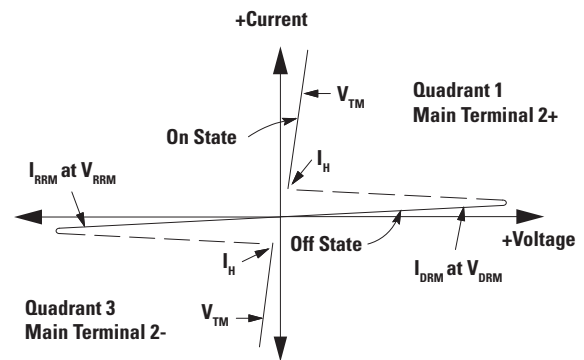

### Quadrant Definitions for a Triac

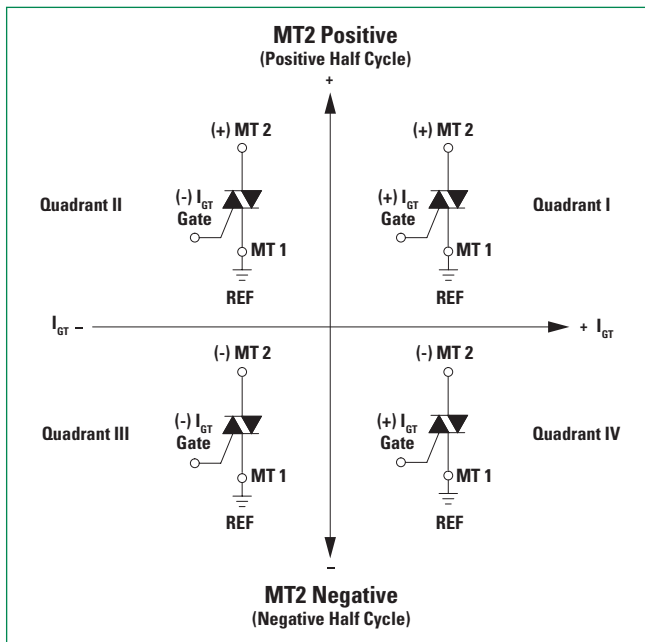

All Polarities are referenced to MT1.  
With in-phase signals (using standard AC lines) quadrants I and III are used

### Dimensions

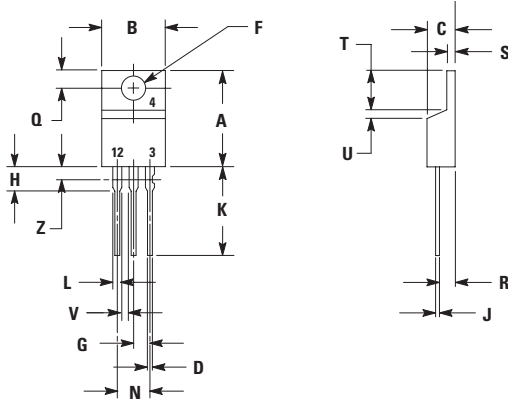

| Dim | Inches |       | Millimeters |       |
|-----|--------|-------|-------------|-------|
|     | Min    | Max   | Min         | Max   |
| A   | 0.590  | 0.620 | 14.99       | 15.75 |
| B   | 0.380  | 0.420 | 9.65        | 10.67 |
| C   | 0.178  | 0.188 | 4.52        | 4.78  |
| D   | 0.025  | 0.035 | 0.64        | 0.89  |
| F   | 0.142  | 0.147 | 3.61        | 3.73  |
| G   | 0.095  | 0.105 | 2.41        | 2.67  |
| H   | 0.110  | 0.130 | 2.79        | 3.30  |
| J   | 0.018  | 0.024 | 0.46        | 0.61  |
| K   | 0.540  | 0.575 | 13.72       | 14.61 |
| L   | 0.060  | 0.075 | 1.52        | 1.91  |
| N   | 0.195  | 0.205 | 4.95        | 5.21  |
| Q   | 0.105  | 0.115 | 2.67        | 2.92  |
| R   | 0.085  | 0.095 | 2.16        | 2.41  |
| S   | 0.045  | 0.060 | 1.14        | 1.52  |
| T   | 0.235  | 0.255 | 5.97        | 6.47  |
| U   | 0.000  | 0.050 | 0.00        | 1.27  |
| V   | 0.045  | —     | 1.15        | —     |
| Z   | —      | 0.080 | —           | 2.04  |

1. DIMENSIONING AND TOLERANCING PER ANSI Y14.5M, 1982.
2. CONTROLLING DIMENSION: INCH.
3. DIMENSION Z DEFINES A ZONE WHERE ALL BODY AND LEAD IRREGULARITIES ARE ALLOWED.

### Part Marking System

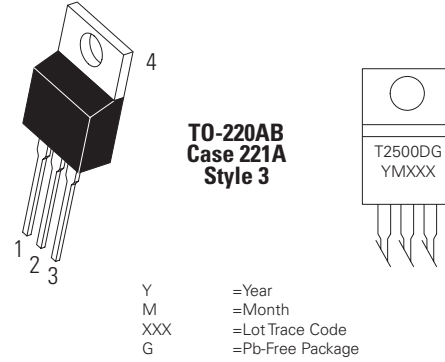

| Pin Assignment |         |
|----------------|---------|
| 1              | Cathode |
| 2              | Anode   |
| 3              | Gate    |
| 4              | Anode   |

### Ordering Information

| Device  | Package           | Shipping       |
|---------|-------------------|----------------|
| T2500D  | TO220AB           | 1000 Units/Box |
| T2500DG | TO220AB (Pb-Free) |                |