

8.0SMDJ Series

Surface Mount – 8000W



Agency Recognitions

Agency	Agency File Number
	E230531

Maximum Ratings and Thermal Characteristics

($T_A=25^{\circ}\text{C}$ unless otherwise noted)

Parameter	Symbol	Value	Unit
Peak Pulse Power Dissipation at $T_L=25^{\circ}\text{C}$ by 10/1000 μs Waveform (Fig.2)(Note 1), (Note 2)	P_{PPM}	8000	W
Power Dissipation on Infinite Heat Sink at $T_L=50^{\circ}\text{C}$	P_D	6.5	W
Peak Forward Surge Current, 8.3ms Single Half Sine Wave (Note 3)	I_{FSM}	300	A
Maximum Instantaneous Forward Voltage at 100A for Unidirectional Only	V_F	5.0	V
Operating Temperature Range	T_J	-65 to 150	$^{\circ}\text{C}$
Storage Temperature Range	T_{STG}	-65 to 175	$^{\circ}\text{C}$
Typical Thermal Resistance Junction to Lead	$R_{\theta JL}$	15	$^{\circ}\text{C}/\text{W}$
Typical Thermal Resistance Junction to Ambient	$R_{\theta JA}$	75	$^{\circ}\text{C}/\text{W}$

Notes:

1. Non-repetitive current pulse, per Fig. 4 and derated above T_J (initial) $=25^{\circ}\text{C}$ per Fig. 3.
2. Mounted on copper pad area of 0.31x0.31" (8.0 x 8.0mm) to each terminal.
3. Measured on 8.3ms single half sine wave or equivalent square wave for unidirectional component only, duty cycle=4 per minute maximum.

Description

The 8.0SMDJ series is designed specifically to protect sensitive electronic equipment from voltage transients induced by lightning and other transient voltage events.

Features and Benefits

- For surface mounted applications to optimize board space
- Low profile package
- Typical failure mode is short from over-specified voltage or current
- Whisker test is conducted based on JEDEC JESD201A per its table 4a and 4c
- IEC-61000-4-2 ESD 30kV(Air), 30kV (Contact)
- ESD protection of data lines in accordance with IEC 61000-4-2
- EFT protection of data lines in accordance with IEC 61000-4-4
- Built-in strain relief
- Glass passivated chip junction
- 8kW peak pulse power capability at 10/1000 μs waveform, repetition rate (duty cycles):0.01%
- Fast response time: typically less than 1.0ps from 0V to VBR min
- Excellent clamping capability
- Compact size with high power density in DO-214AB Package
- Low incremental surge resistance
- Typical IR less than 5 μA when $V_{BR\ min}>22\text{V}$
- High temperature reflow soldering guaranteed: 260 $^{\circ}\text{C}/40\text{sec}$
- $V_{BR} @ T_J = V_{BR} @ 25^{\circ}\text{C} \times (1 + \alpha T \times (T_J - 25))$ (α : Temperature Coefficient, typical value is 0.1%)
- UL Recognized compound meeting flammability rating V-0
- Meet MSL level1, per J-STD-020, LF maximum peak of 260 $^{\circ}\text{C}$
- Matte tin lead-free plated
- Halogen free and RoHS compliant
- Pb-free E3 means 2nd level interconnect is Pb-free and the terminal finish material is tin(Sn) (IPC/JEDEC J-STD-609A.01)

Applications

TVS components are ideal for the protection of I/O Interfaces, VCC bus and other vulnerable circuits used in Telecom, Computer, Industrial and Consumer electronic applications.

Functional Diagram



Bi-directional



Uni-directional

8.0SMDJ Series

Surface Mount – 8000W

Electrical Characteristics ($T_A=25^\circ\text{C}$ unless otherwise noted)

Part Number (Uni)	Part Number (Bi)	Marking		Reverse Stand off Voltage V_R (Volts)	Breakdown Voltage V_{BR} (Volts) @ I_T		Test Current I_T (mA)	Maximum Clamping Voltage V_C @ I_{PP} (10/1000 μs) (V)	Maximum Peak Pulse Current I_{PP} (10/1000 μs) (A)	Maximum Clamping Voltage V_C @ I_{PP} (8/20 μs) (V)	Maximum Peak Pulse Current I_{PP} (8/20 μs) (A)	Maximum Reverse Leakage I_R @ V_R (μA)	Agency Approval 
		UNI	BI		MIN	MAX							
8.0SMDJ12A	8.0SMDJ12CA	8PEP	8BEP	12	13.3	14.7	10	19.9	402.1	25.7	2613.7	800	X
8.0SMDJ13A	8.0SMDJ13CA	8PEQ	8BEQ	13	14.4	15.9	10	21.5	372.1	27.8	2418.7	500	X
8.0SMDJ14A	8.0SMDJ14CA	8PER	8BER	14	15.6	17.2	10	23.2	344.9	30.0	2241.9	200	X
8.0SMDJ15A	8.0SMDJ15CA	8PES	8BES	15	16.7	18.5	1	24.4	327.9	31.5	2131.4	100	X
8.0SMDJ16A	8.0SMDJ16CA	8PET	8BET	16	17.8	19.7	1	26.0	307.7	33.6	2000.1	50	X
8.0SMDJ17A	8.0SMDJ17CA	8PEU	8BEU	17	18.9	20.9	1	27.6	290.0	35.7	1885.0	20	X
8.0SMDJ18A	8.0SMDJ18CA	8PEV	8BEV	18	20.0	22.1	1	29.2	274.0	37.7	1781.0	10	X
8.0SMDJ20A	8.0SMDJ20CA	8PEW	8BEW	20	22.2	24.5	1	32.4	247.0	41.9	1605.5	5	X
8.0SMDJ22A	8.0SMDJ22CA	8PEX	8BEX	22	24.4	26.9	1	35.5	225.4	45.9	1464.8	5	X
8.0SMDJ24A	8.0SMDJ24CA	8PEZ	8BEZ	24	26.7	29.5	1	38.9	205.7	50.3	1336.8	5	X
8.0SMDJ26A	8.0SMDJ26CA	8PFE	8BFE	26	28.9	31.9	1	42.1	190.1	54.4	1235.7	5	X
8.0SMDJ28A	8.0SMDJ28CA	8PFG	8BFG	28	31.1	34.4	1	45.4	176.2	58.7	1145.4	5	X
8.0SMDJ30A	8.0SMDJ30CA	8PFK	8BFK	30	33.3	36.8	1	48.4	165.3	62.5	1074.5	5	X
8.0SMDJ33A	8.0SMDJ33CA	8PFM	8BFM	33	36.7	40.6	1	53.3	150.1	68.9	975.7	5	X
8.0SMDJ36A	8.0SMDJ36CA	8PFP	8BFP	36	40.0	44.2	1	58.1	137.8	75.1	895.7	5	X
8.0SMDJ40A	8.0SMDJ40CA	8PFR	8BFR	40	44.4	49.1	1	64.5	124.1	83.3	806.7	5	X
8.0SMDJ43A	8.0SMDJ43CA	8PFT	8BFT	43	47.8	52.8	1	69.4	115.3	89.7	749.5	5	X
8.0SMDJ45A	8.0SMDJ45CA	8PFV	8BFV	45	50.0	55.3	1	72.7	110.1	93.9	715.7	5	X
8.0SMDJ48A	8.0SMDJ48CA	8PFX	8BFX	48	53.3	58.9	1	77.4	103.4	100.0	671.8	5	X
8.0SMDJ51A	8.0SMDJ51CA	8PFZ	8BFZ	51	56.7	62.7	1	82.4	97.1	106.5	631.2	5	X
8.0SMDJ54A	8.0SMDJ54CA	8PGE	8BGE	54	60.0	66.3	1	87.1	92.0	112.5	598.0	5	X
8.0SMDJ58A	8.0SMDJ58CA	8PGG	8BGG	58	64.4	71.2	1	93.6	85.5	120.9	555.8	5	X
8.0SMDJ60A	8.0SMDJ60CA	8PGK	8BGK	60	66.7	73.7	1	96.8	82.7	125.1	537.2	5	X
8.0SMDJ64A	8.0SMDJ64CA	8PGM	8BGM	64	71.1	78.6	1	103.0	77.7	133.1	504.9	5	X
8.0SMDJ70A	8.0SMDJ70CA	8PGP	8BGP	70	77.8	86.0	1	113.0	71.0	146.0	461.5	5	X
8.0SMDJ75A	8.0SMDJ75CA	8PGR	8BGR	75	83.3	92.1	1	121.0	66.2	156.3	430.3	5	X
8.0SMDJ78A	8.0SMDJ78CA	8PGT	8BGT	78	86.7	95.8	1	126.0	63.5	162.8	412.8	5	X
8.0SMDJ85A	8.0SMDJ85CA	8PGV	8BGV	85	94.4	104.0	1	137.0	58.4	177.0	379.6	5	X
8.0SMDJ90A	8.0SMDJ90CA	8PGX	8BGX	90	100.0	111.0	1	146.0	55.0	188.6	357.5	5	X
8.0SMDJ100A	8.0SMDJ100CA	8PGZ	8BGZ	100	111.0	123.0	1	162.0	49.4	209.3	321.1	5	X
8.0SMDJ110A	8.0SMDJ110CA	8PHE	8BHE	110	122.0	135.0	1	177.0	45.2	228.7	293.8	5	X

For bidirectional type having V_R of 20 volts and less, the I_R limit is double.

8.0SMDJ Series

Surface Mount – 8000W

I-V Curve Characteristics

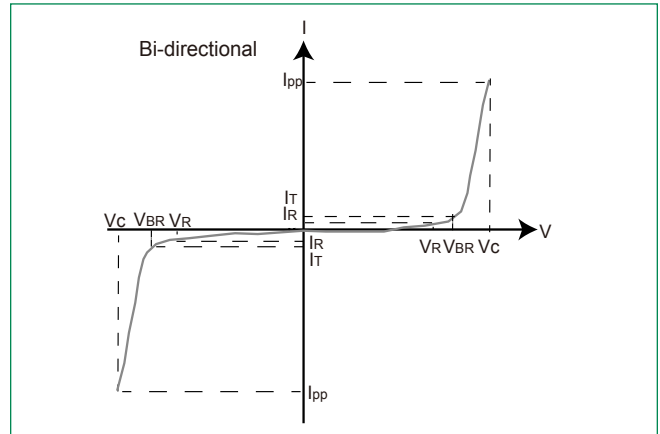
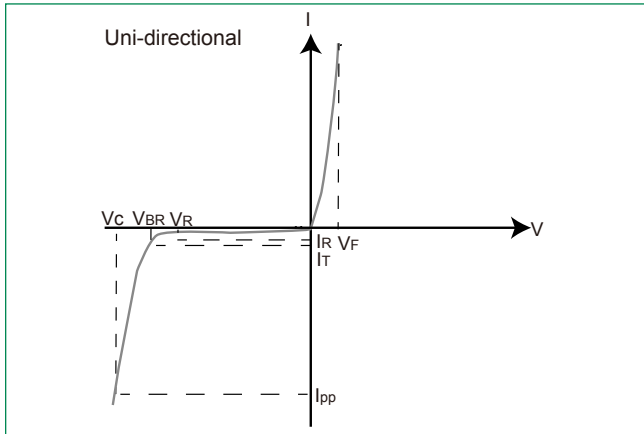

- P_{PPM} Peak Pulse Power Dissipation** -- Max power dissipation
- V_R Stand-off Voltage** -- Maximum voltage that can be applied to the TVS without operation
- V_{BR} Breakdown Voltage** -- Maximum voltage that flows through the TVS at a specified test current (I_T)
- V_C Clamping Voltage** -- Peak voltage measured across the TVS at a specified I_{PPM} (peak impulse current)
- I_R Reverse Leakage Current** -- Current measured at V_R
- V_F Forward Voltage Drop for Uni-directional**

Ratings and Characteristic Curves ($T_A=25^\circ\text{C}$ unless otherwise noted)

Figure 1:
TVS Transients Clamping Waveform

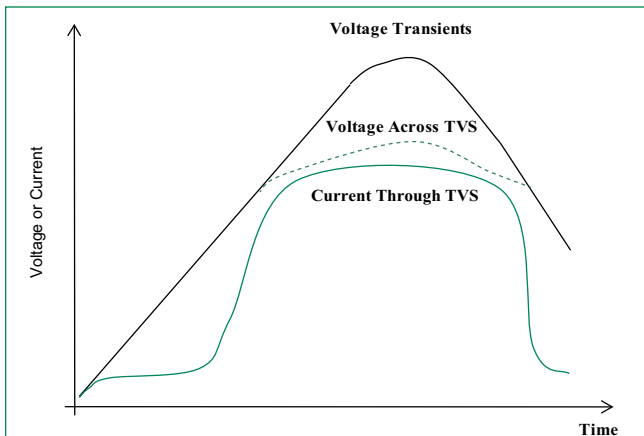
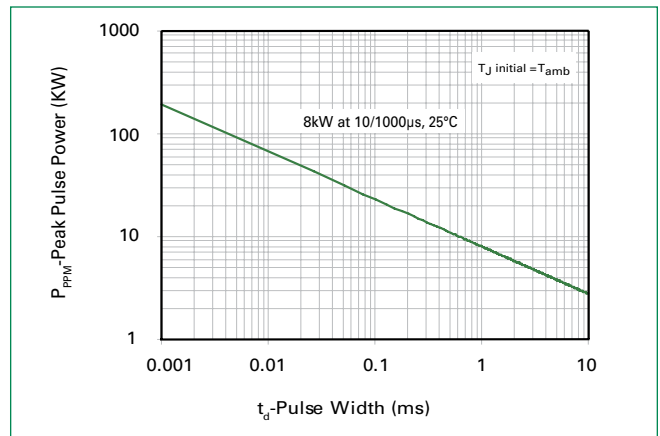

Figure 2:
Peak Pulse Power Rating



continues on next page.

8.0SMDJ Series

Surface Mount – 8000W

Ratings and Characteristic Curves ($T_A=25^\circ\text{C}$ unless otherwise noted) (Continued)

Figure 3:
Peak Pulse Power Derating Curve

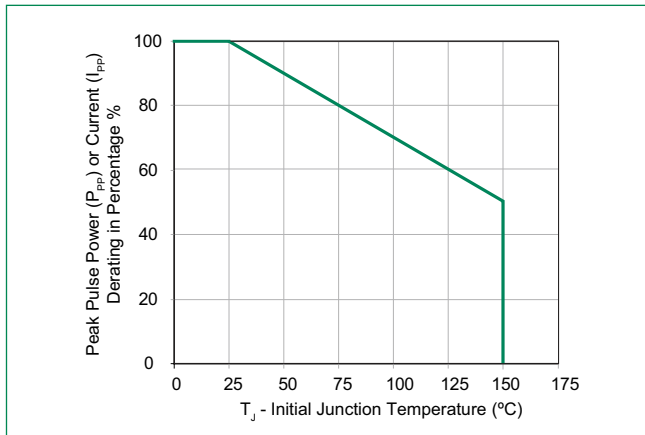

Figure 4:
Pulse Waveform

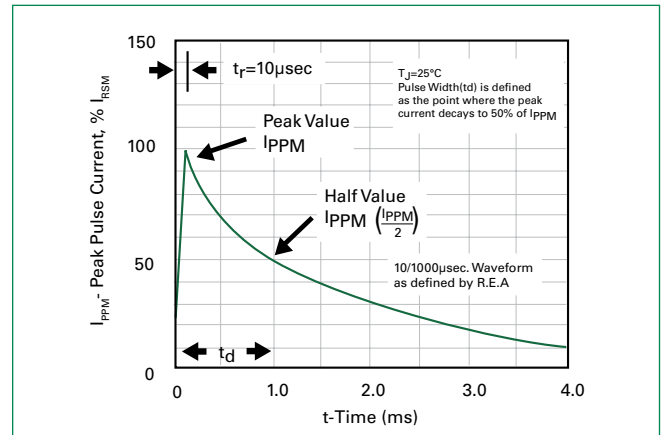

Figure 5:
Typical Junction Capacitance

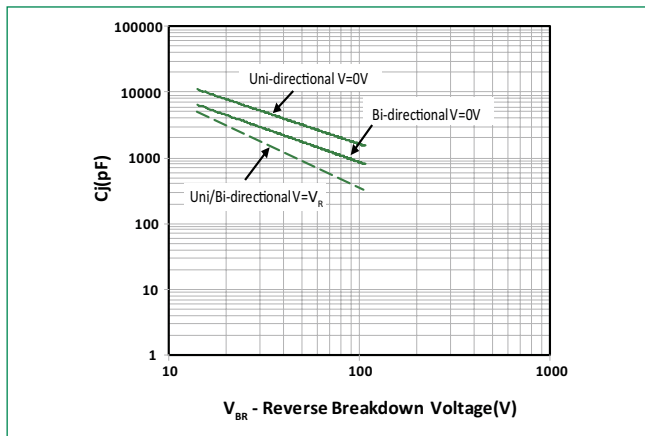

Figure 6:
Typical Transient Thermal Impedance

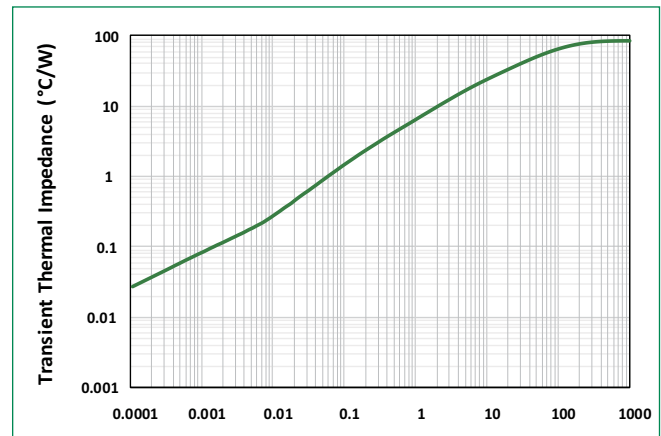

Figure 7:
Maximum Non-Repetitive Peak Forward Surge Current Uni-Directional Only

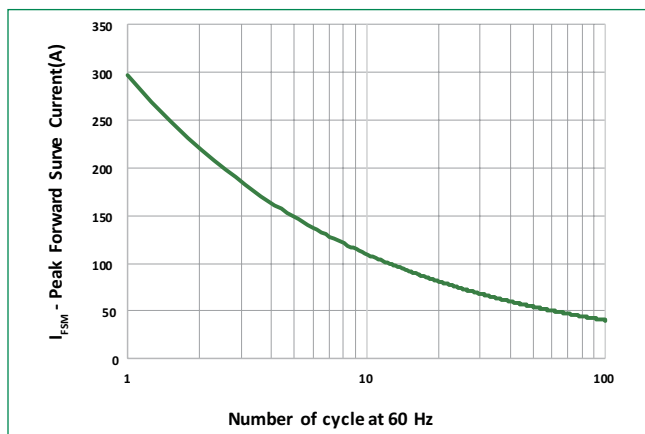
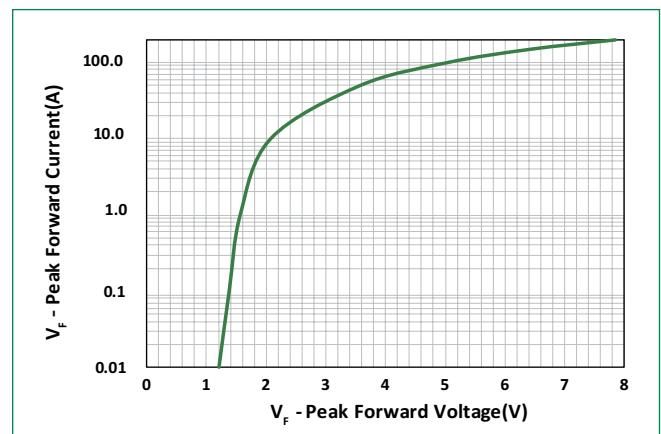

Figure 8:
Peak Forward Voltage Drop vs Peak Forward Current (Typical Values)



8.0SMDJ Series

Surface Mount – 8000W

Soldering Parameters

Reflow Condition		Lead-free assembly
Pre Heat	- Temperature Min ($T_{s(min)}$)	150°C
	- Temperature Max ($T_{s(max)}$)	200°C
	- Time (min to max) (t_p)	60 – 120 secs
Average ramp up rate (Liquidus Temp (T_A) to peak)		3°C/second max
$T_{s(max)}$ to T_A - Ramp-up Rate		3°C/second max
Reflow	- Temperature (T_L) (Liquidus)	217°C
	- Time (min to max) (t_L)	60 – 150 seconds
Peak Temperature (T_p)		260 ^{+0/-5} °C
Time within 5°C of actual peak Temperature (t_p)		30 seconds
Ramp-down Rate		6°C/second max
Time 25°C to peak Temperature (T_p)		8 minutes Max.
Do not exceed		260°C

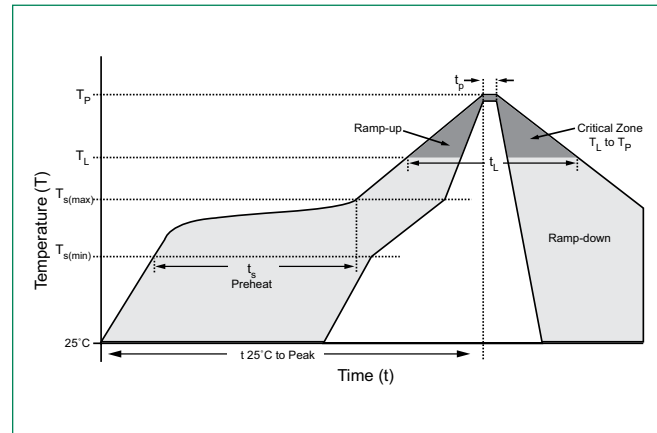

Physical Specifications

Weight	0.011 ounce ,0.3 grams
Case	JEDEC DO214AB. Molded plastic body over glass passivated junction
Polarity	Color band denotes positive end (cathode) except Bidirectional.
Terminal	Matte Tin-plated leads, Solderable per JESD22-B102

Environmental Specifications

High Temp. Storage	JESD22-A103
HTRB	JESD22-A108
Temperature Cycling	JESD22-A104
MSL	JEDEC-J-STD-020, Level 1
H3TRB	JESD22-A101
RSH	JESD22-A111

Dimensions

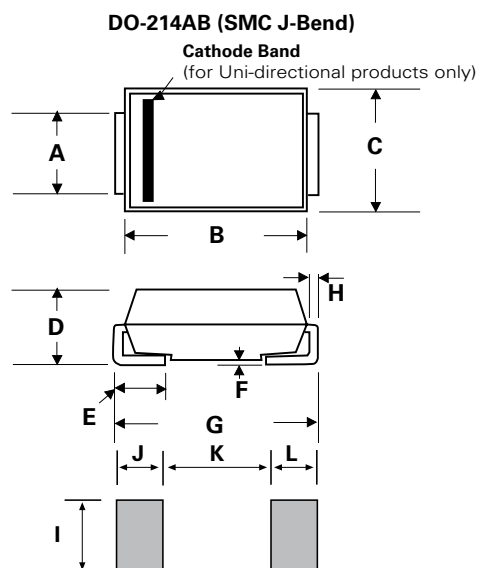

Dimensions	Inches		Millimeters	
	Min	Max	Min	Max
A	0.114	0.126	2.900	3.200
B	0.260	0.280	6.600	7.110
C	0.220	0.245	5.590	6.220
D	0.079	0.103	2.060	2.620
E	0.030	0.060	0.760	1.520
F	-	0.008	-	0.203
G	0.305	0.320	7.750	8.130
H	0.006	0.012	0.152	0.305
I	0.129	-	3.300	-
J	0.094	-	2.400	-
K	-	0.165	-	4.200
L	0.094	-	2.400	-

8.0SMDJ Series

Surface Mount – 8000W

Part Numbering System

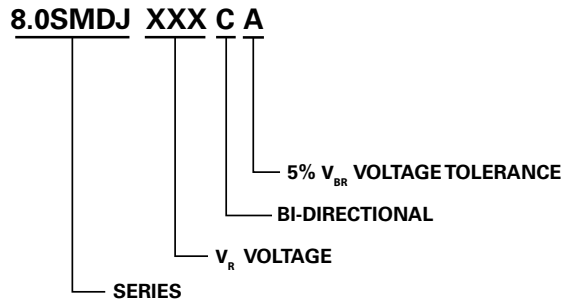

Part Marking System

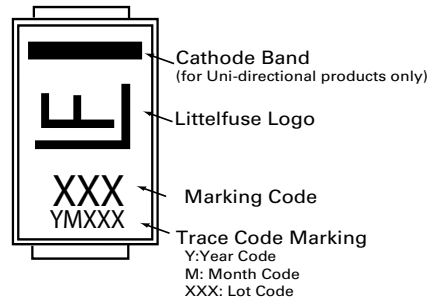

Packaging Options

Part number	Component Package	Quantity	Packaging Option	Packaging Specification
8.0SMDJxxxXX	DO-214AB	3000	Tape & Reel - 16mm tape/13" reel	EIA STD RS-481
8.0SMDJxxxXX-T7	DO-214AB	500	Tape & Reel - 16mm tape/7" reel	EIA STD RS-481

Tape and Reel Specification

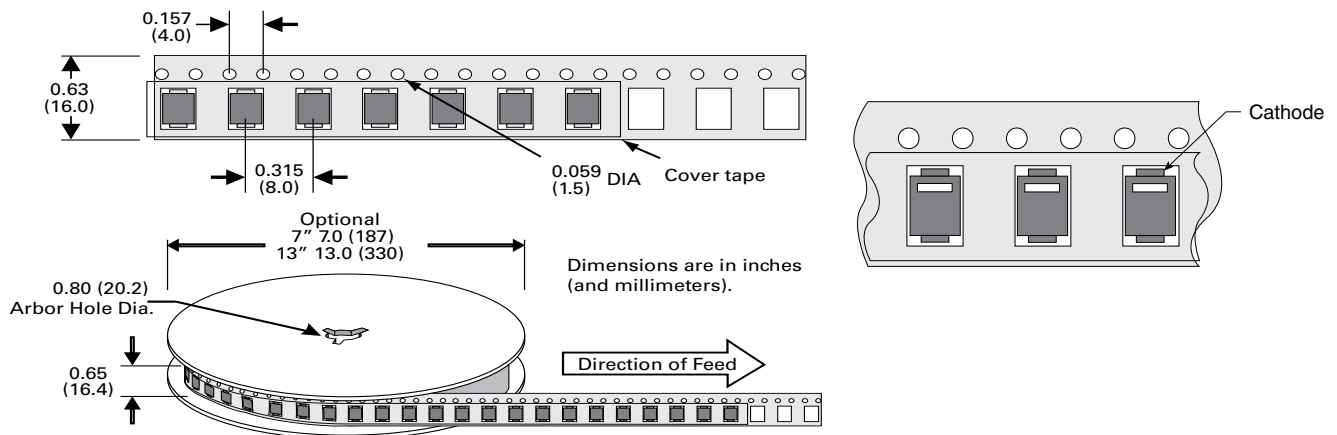

Disclaimer Notice - Information furnished is believed to be accurate and reliable. However, users should independently evaluate the suitability of and test each product selected for their own applications. Littelfuse products are not designed for, and may not be used in, all applications. Read complete Disclaimer Notice at <http://www.littelfuse.com/disclaimer-electronics>.