

AQ0502-02RTG

5V, 1.0pF, SOT523, Unidirectional TVS, Low Capacitance ESD protection

**Description**

The AQ0502-02RTG provides low capacitance, 2 channel unidirectional and a high level of protection for electronic equipment that may experience destructive electrostatic discharges (ESD). The typical capacitance of 1.0pF helps ensure excellent signal integrity on the most challenging consumer electronics interfaces, such as USB2.0, 10/100/1000 ethernet, display port.

It can safely absorb repetitive ESD strikes at ± 22 kV (contact discharge, IEC 61000-4-2) without performance degradation and safely dissipate 2.5 A of 8/20 μ s surge current (IEC 61000-4-5 2nd edition).

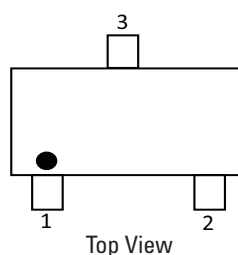
Pinout**Features**

- ESD, IEC 61000-4-2, ± 22 kV contact, ± 27 kV air
- ESD, ISO 10605, 330 pF 330 Ω , ± 20 kV contact/air
- EFT, IEC 61000-4-4, 40 A (5/50 ns)
- Maximum surge tolerance, IEC 61000-4-5 2nd edition, 2.5 A (8/20 μ s)
- Low capacitance of 1 pF@1 MHz (Typ@V_R = 0 V)
- Low leakage current of 1 nA (Typ) at 5.0 V
- Halogen-free, lead-free and RoHS compliant
- Moisture sensitivity level (MSL-1)
- AEC-Q101 qualified and PPAP capable

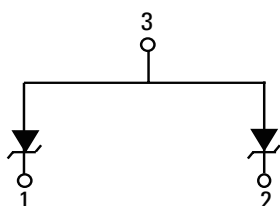
Functional Block Diagram**Applications**

- Automotive
- USB2.0
- Display port
- 10/100/1000 Ethernet

Life Support Note:

Not Intended for Use in Life Support or Life Saving Applications

The products shown herein are not designed for use in life sustaining or life saving applications unless otherwise expressly indicated.

AQ0502-02RTG

5V, 1.0pF, SOT523, Unidirectional TVS, Low Capacitance ESD protection

Absolute Maximum Ratings

| Symbol | Parameter | Value | Units |
|------------|-------------------------------------|------------|-------|
| I_{PP} | Peak Current ($t_p = 8/20 \mu s$) | 2.5 | A |
| T_{OP} | Operating Temperature | -40 to 150 | °C |
| T_{STOR} | Storage Temperature | -55 to 150 | °C |

CAUTION: Stresses above those listed in "Absolute Maximum Ratings" may cause permanent damage to the component. This is a stress only rating and operation of the component at these or any other conditions above those indicated in the operational sections of this specification is not implied.

Electrical Characteristics ($T_{OP} = 25 \text{ }^\circ\text{C}$)

| Parameter | Symbol | Test Conditions | Min | Typ | Max | Units |
|--------------------------------------|--------------|--|----------|------|-----|----------|
| Reverse Standoff Voltage | V_{RWM} | | | | 5 | V |
| Breakdown Voltage | V_{BR} | $I_R = 1 \text{ mA}$ | | 8.2 | | V |
| Reverse Leakage Current | I_{LEAK} | $V_R = 5 \text{ V}$ | | 1 | 50 | nA |
| Clamp Voltage ¹ | V_C | $I_{PP} = 1 \text{ A}$, $t_p = 8/20 \mu s$, I/O to GND | | 10.5 | | V |
| | | $I_{PP} = 2.5 \text{ A}$, $t_p = 8/20 \mu s$, I/O to GND | | 13.2 | | V |
| Dynamic Resistance ^{1,2} | R_{DYN} | TLP, $t_p = 100 \text{ ns}$, I/O to GND | | 0.78 | | Ω |
| ESD Withstand Voltage ^{1,3} | V_{ESD} | IEC 61000-4-2 (Contact Discharge) | ± 22 | | | kV |
| | | IEC 61000-4-2 (Air Discharge) | ± 27 | | | kV |
| | | ISO10605 (Contact Discharge) | ± 20 | | | kV |
| | | ISO10605 (Air Discharge) | ± 20 | | | kV |
| Diode Capacitance ¹ | C_{IO-GND} | Reverse Bias = 0 V, $f = 1 \text{ MHz}$, I/O to GND | | 1.0 | | pF |
| | C_{IO-IO} | Reverse Bias = 0 V, $f = 1 \text{ MHz}$, I/O to I/O | | 0.6 | | pF |

Note:

- Parameter is guaranteed by design and/or component characterization.
- Transmission Line Pulse (TLP) with 100ns width, 0.2 ns rise time, and average window $t_1 = 70 \text{ ns}$ to $t_2 = 90 \text{ ns}$.
- Device stressed with ten non-repetitive ESD pulses according to IEC61000-4-2 ($R = 330 \Omega$, $C = 150 \text{ pF}$).
- Device stressed with three non-repetitive ESD pulses according to ISO10605 ($R = 330 \Omega$, $C = 330 \text{ pF}$).

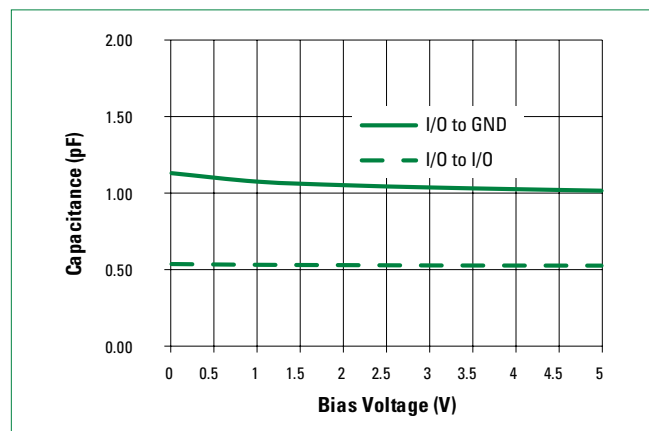
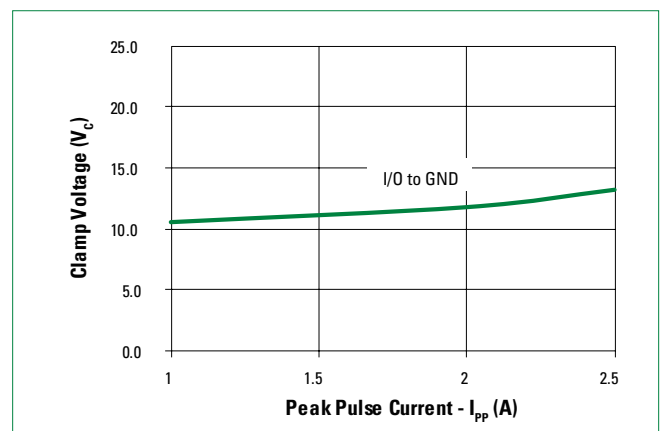
Capacitance vs. Reverse Bias**Clamping Voltage vs I_{PP}** 

AQ0502-02RTG

5V, 1.0pF, SOT523, Unidirectional TVS, Low Capacitance ESD protection

Positive Transmission Line Pulsing (TLP) Plot

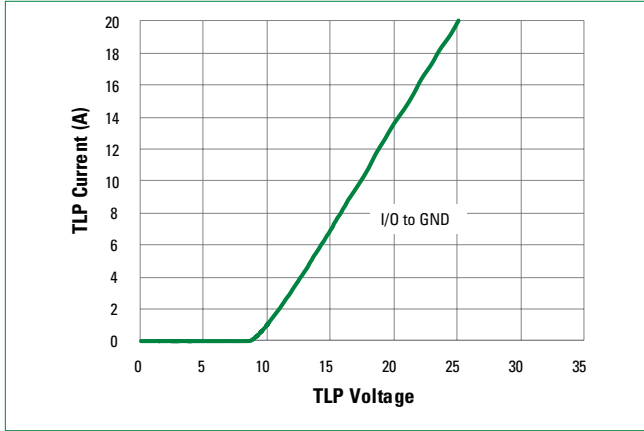

Negative Transmission Line Pulsing (TLP) Plot

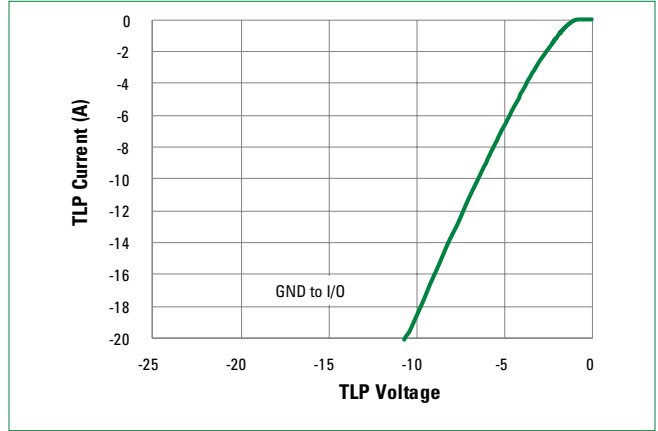

IEC 61000-4-2 +8 kV Contact ESD Clamping Voltage

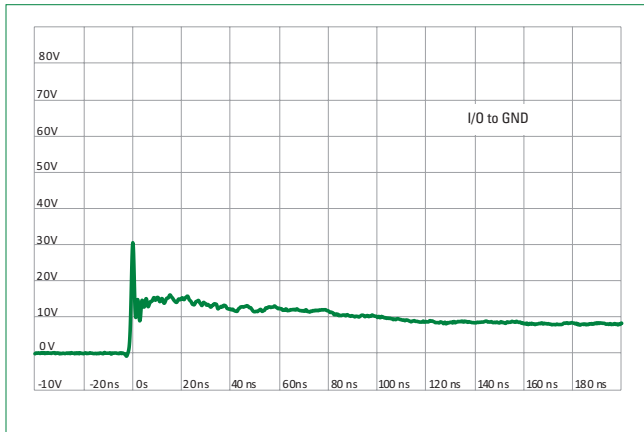

IEC 61000-4-2 -8 kV Contact ESD Clamping Voltage

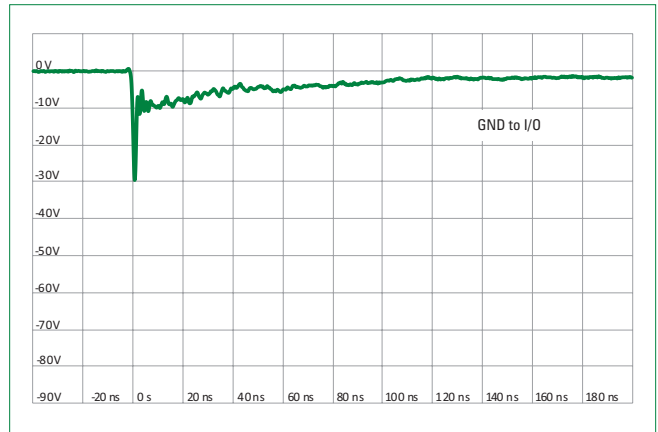

ISO10605 Contact Discharge Plot at +8 kV

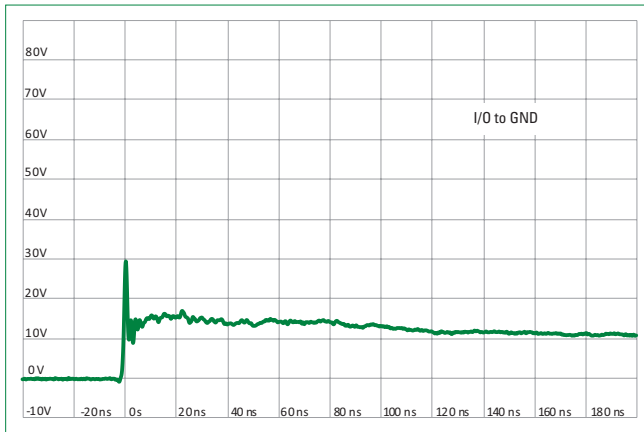

ISO10605 Contact Discharge Plot at -8 kV

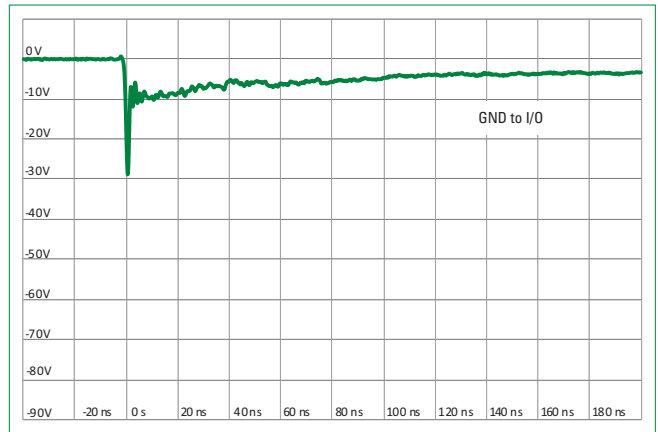

AQ0502-02RTG

5V, 1.0pF, SOT523, Unidirectional TVS, Low Capacitance ESD protection

Soldering Parameters

| | | |
|--|------------------------------------|-------------------------|
| Reflow Condition | | Pb – free assembly |
| Pre Heat | - Temperature Min ($T_{s(min)}$) | 150 °C |
| | - Temperature Max ($T_{s(max)}$) | 200 °C |
| | - Time (min to max) (t_s) | 60 – 120 seconds |
| Average Ramp up Rate (Liquidus) Temp (T_L) to Peak | | 3 °C/second max |
| $T_{s(max)}$ to T_L - Ramp-up Rate | | 3 °C/second max |
| Reflow | - Temperature (T_L) (Liquidus) | 217 °C |
| | - Temperature (t_L) | 60 – 150 seconds |
| Peak Temperature (T_p) | | 260 ^{+0/-5} °C |
| Time within 5 °C of Actual Peak Temperature (t_p) | | 30 seconds |
| Ramp-down Rate | | 6 °C/second max |
| Time 25 °C to Peak Temperature (T_p) | | 8 minutes max |
| Do Not Exceed | | 260 °C |

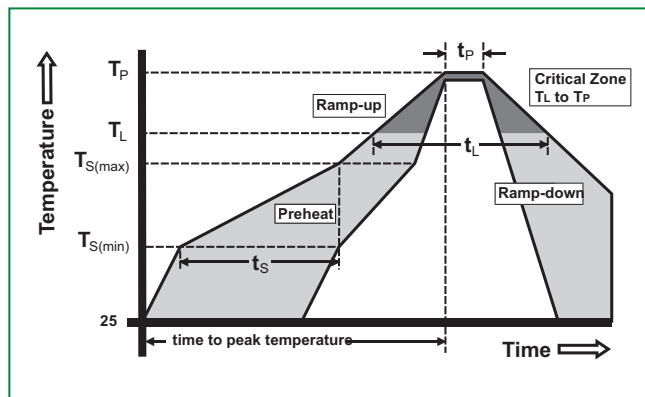
**Ordering Information**

| Part Number | Package | Min. Order Qty. |
|--------------|-----------|-----------------|
| AQ0502-02RTG | SOT523-3L | 3000 |

Product Characteristics

| | |
|----------------------|--|
| Lead Plating | Matte tin |
| Lead Material | Copper alloy |
| Body Material | Molded compound |
| Flammability | UL recognized compound meeting flammability rating V-0 |

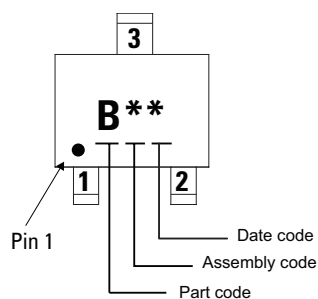
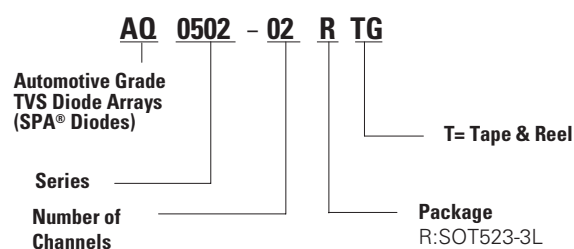
Part Marking System**Part Numbering System**

AQ0502-02RTG

5V, 1.0pF, SOT523, Unidirectional TVS, Low Capacitance ESD protection

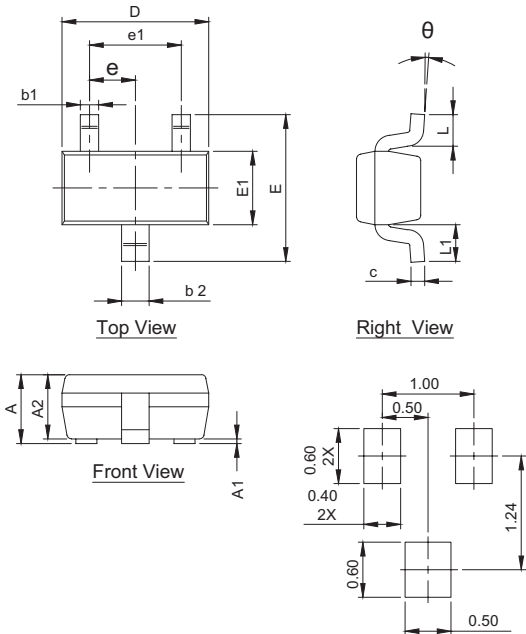
Package Dimensions – SOT523-3L

| Symbol | Millimeters | | Inches | |
|--------|-------------|-------|------------|--------|
| | Min | Max | Min | Max |
| A | 0.700 | 0.900 | 0.0276 | 0.0354 |
| A1 | 0.000 | 0.100 | 0.0000 | 0.0039 |
| A2 | 0.700 | 0.800 | 0.0276 | 0.0315 |
| b1 | 0.150 | 0.250 | 0.0059 | 0.0098 |
| b2 | 0.250 | 0.350 | 0.0098 | 0.0138 |
| c | 0.100 | 0.200 | 0.0039 | 0.0079 |
| D | 1.500 | 1.700 | 0.0591 | 0.0669 |
| E | 1.450 | 1.750 | 0.0571 | 0.0689 |
| E1 | 0.700 | 0.900 | 0.0276 | 0.0354 |
| e | 0.500 TYP | | 0.0197 TYP | |
| e1 | 0.900 | 1.100 | 0.0354 | 0.0433 |
| L | 0.260 | 0.460 | 0.0102 | 0.0181 |
| L1 | 0.400 REF | | 0.0157 REF | |
| θ | 0° | 8° | 0° | 8° |

Recommended Soldering Pattern (unit :mm)

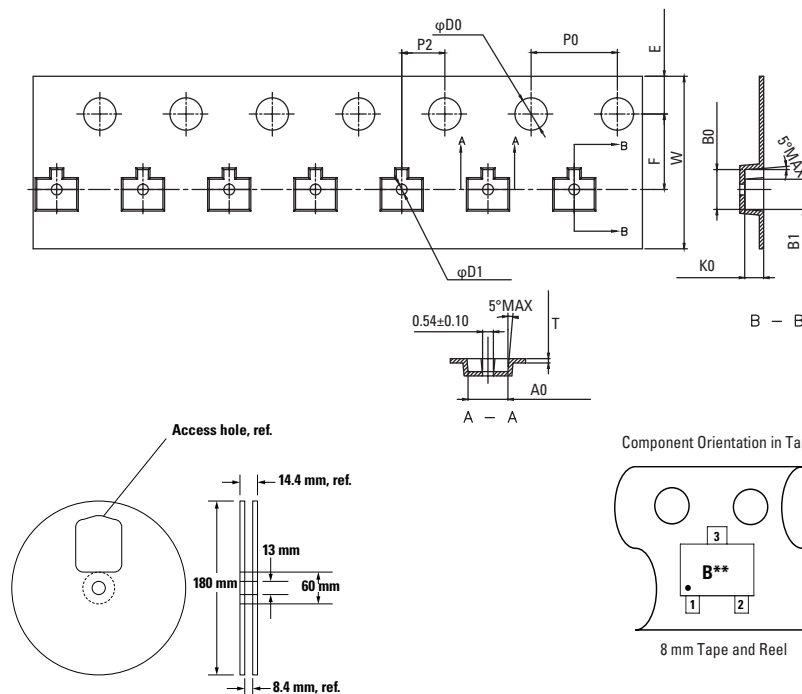
Embossed Carrier Tape & Reel Specification – SOT523-3L

| Symbol | Millimeters |
|--------|---------------|
| A0 | 1.85±/0.05 |
| B0 | 1.85±/0.05 |
| B1 | 1.40±/0.05 |
| W | 8.0+0.3/-0.10 |
| D0 | ∅1.50+0.10 |
| D1 | ∅0.50±/0.10 |
| E | 1.75±/0.10 |
| F | 3.50±/0.05 |
| P0 | 4.00±/0.10 |
| P2 | 2.00±/0.05 |
| K0 | 0.90+0.03 |
| T | 0.20±/0.02 |

Product Disclaimer: Littelfuse products are not designed for, and shall not be used for, any purpose (including, without limitation, automotive, military, aerospace, medical, life-saving, life-sustaining or nuclear facility applications, devices intended for surgical implant into the body, or any other application in which the failure or lack of desired operation of the product may result in personal injury, death, or property damage) other than those expressly set forth in applicable Littelfuse product documentation. Warranties granted by Littelfuse shall be deemed void for products used for any purpose not expressly set forth in applicable Littelfuse documentation. Littelfuse shall not be liable for any claims or damages arising out of products used in applications not expressly intended by Littelfuse as set forth in applicable Littelfuse documentation. The sale and use of Littelfuse products is subject to Littelfuse Terms and Conditions of Sale, unless otherwise agreed by Littelfuse. "Littelfuse" includes Littelfuse, Inc., and all of its affiliate entities. <http://www.littelfuse.com/disclaimer-electronics>.