

AQ1205-01UTG

4.5 V, 7 A, 0201DFN, Bidirectional Discrete TVS Diode, General Purpose ESD Protection

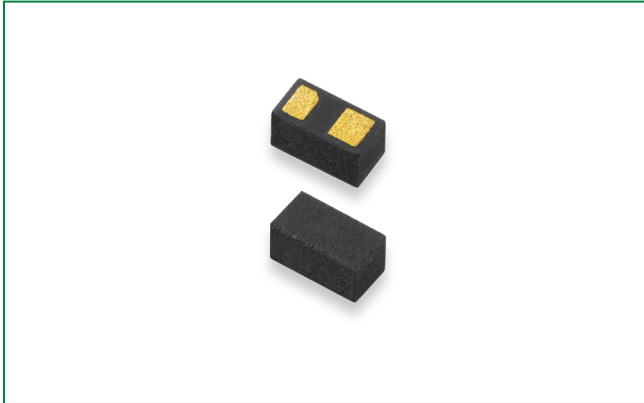

Note: This package image is for example and reference only. For detail package drawing, please refer to the package section in this datasheet.

Pinout

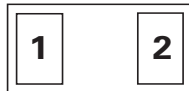

Functional Block Diagram

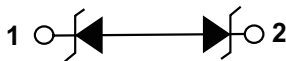

Description

The AQ1205-01UTG bidirectional TVS is fabricated in a proprietary silicon avalanche technology. These diodes provide a high ESD (electrostatic discharge) protection level for electronic equipment. The AQ1205-01UTG TVS can safely absorb repetitive ESD strikes of ± 30 kV (contact and air discharge as defined in IEC 61000-4-2) without any performance degradation. In addition, it can safely dissipate a 7 A 8/20 μ s surge event as defined in IEC 61000-4-5, 2nd edition.

Features and Benefits

- ESD, IEC 61000-4-2, ± 30 kV contact/air
- ESD, ISO10605 330 pF 330 Ω , ± 30 kV contact/air
- EFT, IEC 61000-4-4, 40 A (5/50 ns)
- Maximum surge tolerance, IEC 61000-4-5, 2nd edition, 7 A (8/20 μ s)
- Low leakage current of 20 nA (max) at 4.5 V
- Low clamping voltage
- Halogen-free, lead-free and RoHS compliant
- Moisture sensitivity level (MSL-1)
- AEC-Q101 qualified and PPAP capable

Applications

- Automotive
- Battery Protection
- BMS
- Computer Peripherals
- Medical Equipment
- Notebooks / Desktops / Servers
- Point-of-Sale Terminals
- Switches / Buttons
- Test Equipment / Instrumentation

Life Support Note:

Not Intended for Use in Life Support or Life Saving Applications

The products shown herein are not designed for use in life sustaining or life saving applications unless otherwise expressly indicated.

AQ1205-01UTG

4.5 V, 7 A, 0201DFN, Bidirectional Discrete TVS Diode, General Purpose ESD Protection

Absolute Maximum Ratings

Symbol	Parameter	Value	Units
I_{PP}	Peak Current ($t_p = 8/20 \mu s$)	7	A
T_{OP}	Operating Temperature	-40 to 150	°C
T_{STOR}	Storage Temperature	-55 to 150	°C

Caution: Stresses above those listed in "Absolute Maximum Ratings" may cause permanent damage to the component. This is a stress only rating and operation of the component at these or any other conditions above those indicated in the operational sections of this specification is not implied.

Electrical Characteristics ($T_{OP} = 25 \text{ }^\circ\text{C}$)

Parameter	Symbol	Test Conditions	Min	Typ	Max	Units
Reverse Standoff Voltage	V_{RWM}	$I_R = 1 \mu A$			4.5	V
Breakdown Voltage	V_{BR}	$I_R = 1 \text{ mA}$	5.0	5.5		V
Reverse Leakage Current	I_{LEAK}	$V_R = 4.5 \text{ V}$		1	20	nA
Clamp Voltage ¹	V_C	$I_{PP} = 1 \text{ A}$, $t_p = 8/20 \mu s$, I/O to GND		6.5		V
		$I_{PP} = 7 \text{ A}$, $t_p = 8/20 \mu s$, I/O to GND		10.0		V
Dynamic Resistance ²	R_{DYN}	TLP, $t_p = 100 \text{ ns}$, I/O to GND		0.20		Ω
ESD Withstand Voltage ^{1,3}	V_{ESD}	IEC 61000-4-2 (Contact Discharge)	± 30			kV
		IEC 61000-4-2 (Air Discharge)	± 30			kV
		ISO 10605 (Contact Discharge)	± 30			kV
		ISO 10605 (Air Discharge)	± 30			kV
Diode Capacitance ¹	C_{IO-GND}	Reverse Bias = 4.5 V, $f = 1 \text{ MHz}$		7	9	pF

Note:

- Parameter is guaranteed by design and/or component characterization.
- Transmission Line Pulse (TLP) with 100 ns width, 0.2 ns rise time, and average window $t_1 = 70 \text{ ns}$ to $t_2 = 90 \text{ ns}$.
- Device stressed with ten non-repetitive ESD pulses according to IEC61000-4-2 ($R = 330 \Omega$, $C = 150 \text{ pF}$).
- Device stressed with three non-repetitive ESD pulses according to ISO10605 ($R = 330 \Omega$, $C = 330 \text{ pF}$).

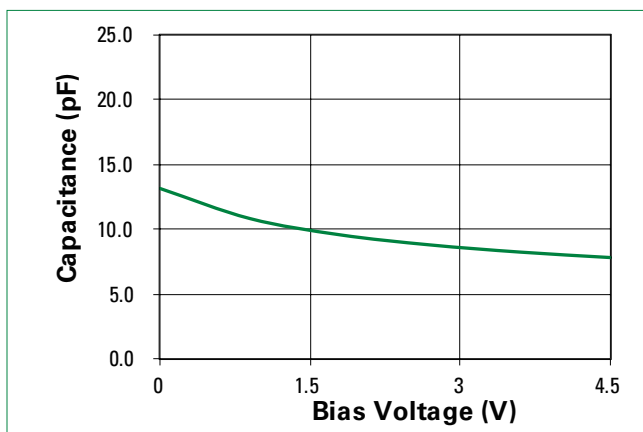
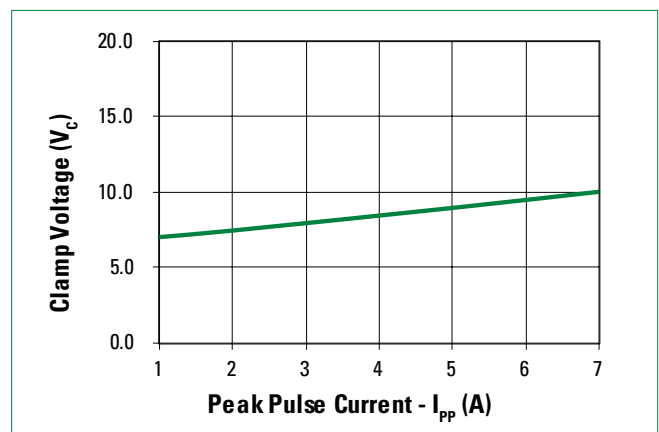
Capacitance vs. Reverse Bias**Clamping Voltage vs I_{PP}** 

AQ1205-01UTG

4.5 V, 7 A, 0201DFN, Bidirectional Discrete TVS Diode, General Purpose ESD Protection

Positive Transmission Line Pulsing (TLP) Plot

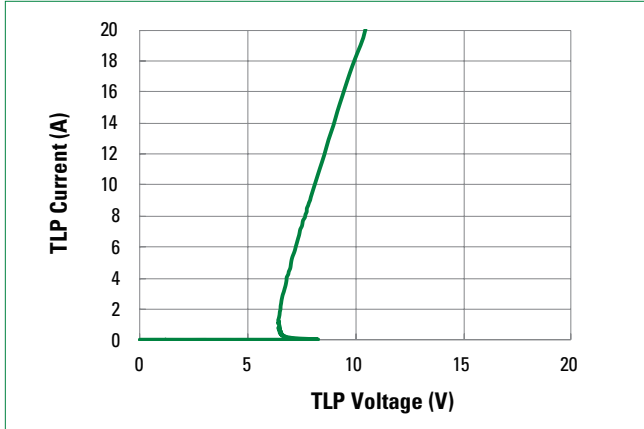

Negative Transmission Line Pulsing (TLP) Plot

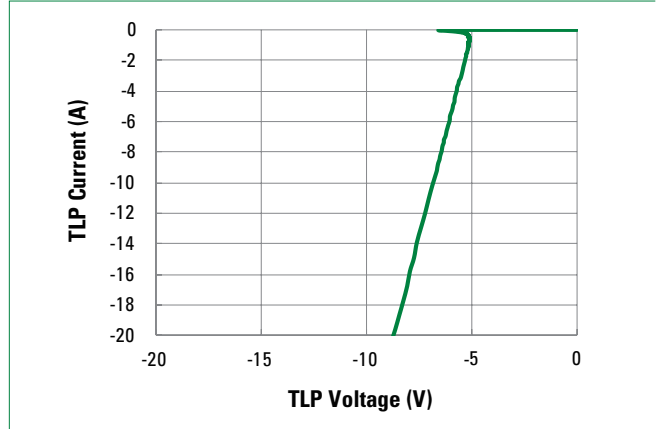

IEC 61000-4-2 +8 kV Contact ESD Clamping Voltage

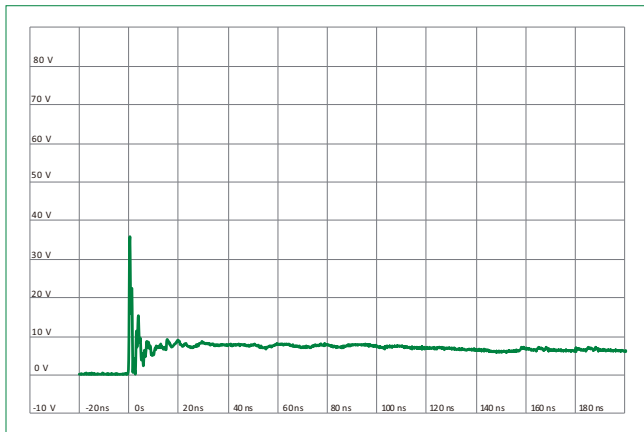

IEC 61000-4-2 -8 kV Contact ESD Clamping Voltage

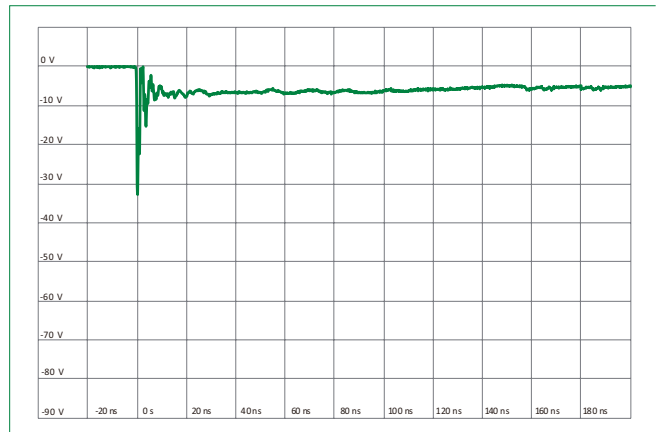

ISO10605 Contact Discharge Plot at +8 kV



ISO10605 Contact Discharge Plot at -8 kV

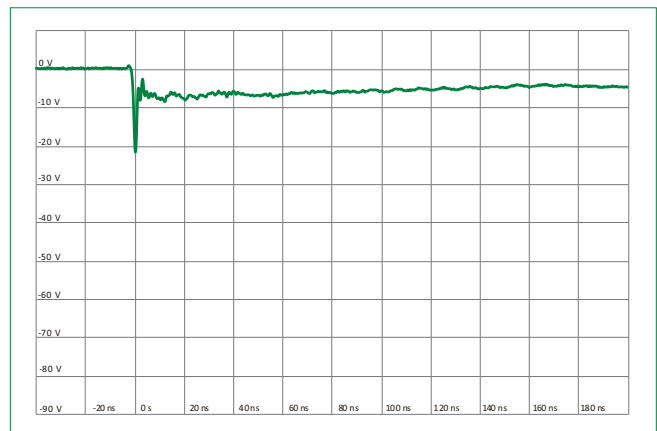

AQ1205-01UTG

4.5 V, 7 A, 0201DFN, Bidirectional Discrete TVS Diode, General Purpose ESD Protection

Soldering Parameters

Reflow Condition		Pb – free assembly
Pre Heat	- Temperature Min ($T_{s(min)}$)	150 °C
	- Temperature Max ($T_{s(max)}$)	200 °C
	- Time (min to max) (t_s)	60 – 120 seconds
Average Ramp Up Rate (Liquidus) Temp (T_L) to Peak		3 °C/second max
$T_{s(max)}$ to T_L - Ramp-up Rate		3 °C/second max
Reflow	- Temperature (T_L) (Liquidus)	217 °C
	- Temperature (t_L)	60 – 150 seconds
Peak Temperature (T_p)		260 ^{+0/-5} °C
Time Within 5 °C of Actual Peak Temperature (t_p)		30 seconds
Ramp-down Rate		6 °C/second max
Time 25 °C to Peak Temperature (T_p)		8 minutes max
Do Not Exceed		260 °C

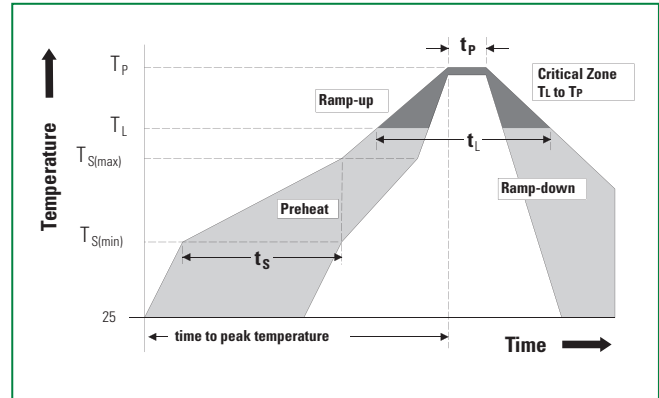

Ordering Information

Part Number	Package	Min. Order Qty.
AQ1205-01UTG	0201DFN	15000

Product Characteristics

Lead Plating	Pre-Plated frame
Lead Material	Copper alloy
Body Material	Molded compound
Flammability	UL recognized compound meeting flammability rating V-0

Part Marking System

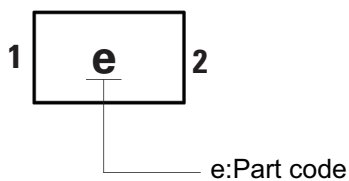

Part Numbering System

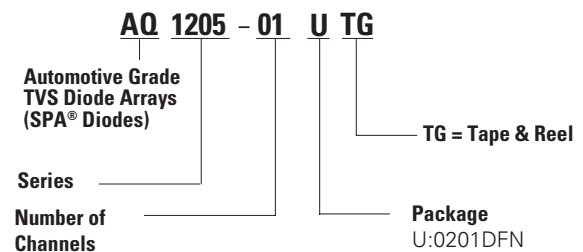

AQ1205-01UTG

4.5 V, 7 A, 0201DFN, Bidirectional Discrete TVS Diode, General Purpose ESD Protection

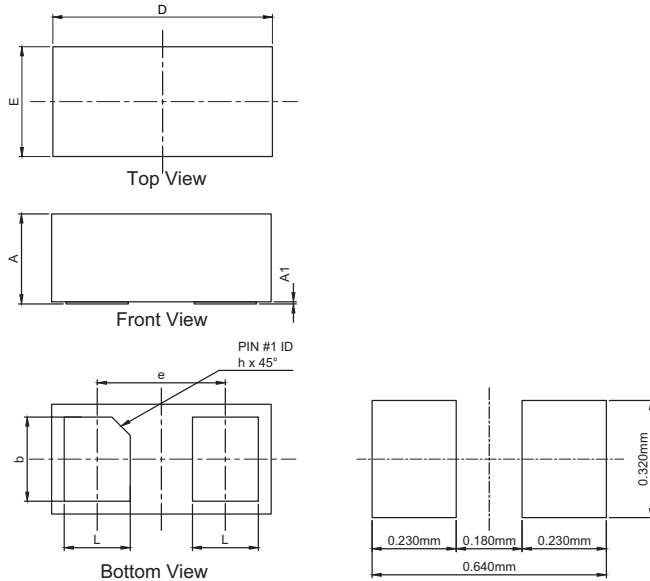
Package Dimensions — 0201DFN

Symbol	0201DFN			
	Millimeters		Inches	
	Min	Max	Min	Max
A	0.280	0.320	0.011	0.013
A1	0.000	0.050	0.000	0.002
b	0.180	0.300	0.007	0.012
L	0.120	0.240	0.005	0.009
D	0.550	0.650	0.022	0.026
E	0.250	0.350	0.010	0.014
h	0.000	0.100	0.000	0.004
e	0.350 BSC		0.014 BSC	

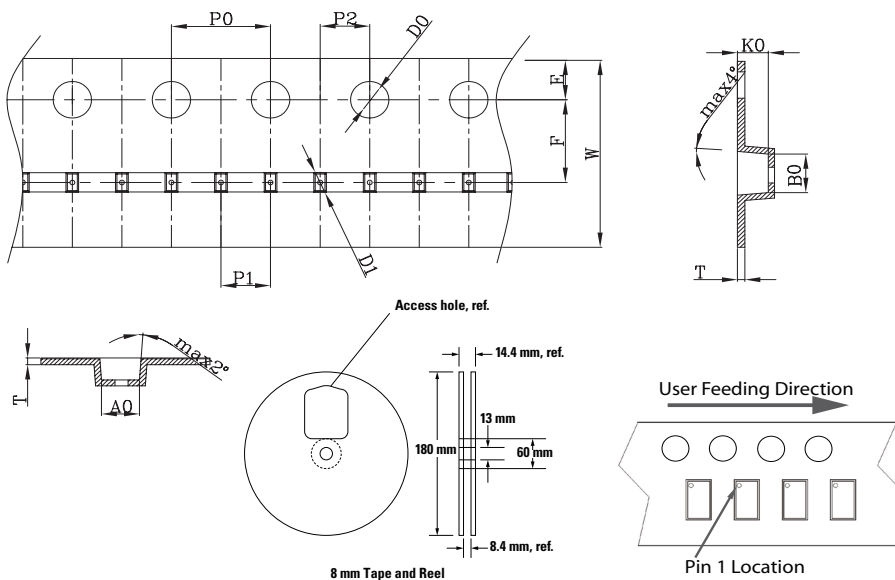
Embossed Carrier Tape & Reel Specification — 0201DFN

Symbol	Millimeters
A0	0.36+/-0.03
B0	0.66+/-0.03
K0	0.33+/-0.03
P0	4.00+/-0.10
P1	2.00+/-0.10
P2	2.00+/-0.05
T	0.23+/-0.02
E	1.75+/-0.10
F	3.50+/-0.05
D0	1.50+0.10
D1	0.20+/-0.05
W	8.00+/-0.10

Disclaimer Notice - Information furnished is believed to be accurate and reliable. However, users should independently evaluate the suitability of and test each product selected for their own applications. Littelfuse products are not designed for, and may not be used in, all applications. Read complete Disclaimer Notice at <http://www.littelfuse.com/disclaimer-electronics>.