

## AQ3400, 1pF, ±30kV Diode Array

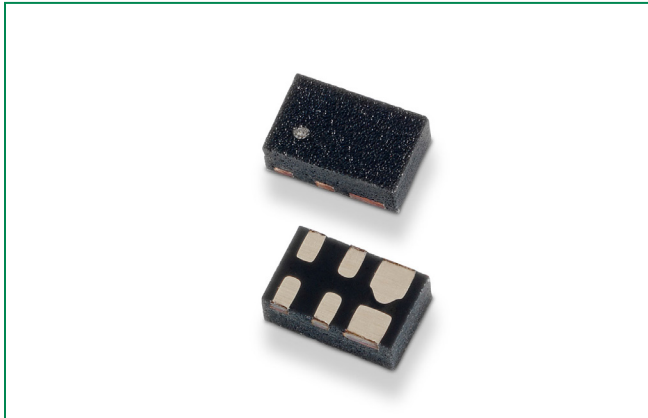

### Description

The AQ3400 integrates 2 channels of low capacitance steering diodes and an additional zener diode to provide protection for electronic equipment that may experience destructive electrostatic discharges (ESD). The AQ3400 can safely absorb repetitive ESD strikes above the maximum contact level specified in IEC 61000-4-2 international standard (Level 4, ±8kV contact discharge) without performance degradation.

The low off-state capacitance makes it ideal for protecting high-speed signal lines such as USB2.0 or USB 3.0 and 1Gb Ethernet with an extremely low dynamic resistance to protect the most sensitive, state of the art chipsets against ESD transients.

### Pinout

I/O1	1	6	NC
I/O2	2	5	NC
GND	3	4	GND

### Functional Block Diagram

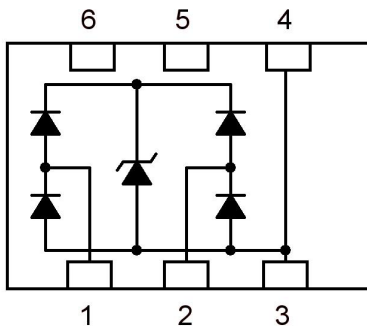

### Features

- ESD, IEC 61000-4-2, ±30kV contact, ±30kV air
- ESD, ISO 10605, 330pF 330Ω, ±30kV contact, ±30kV air
- EFT, IEC 61000-4-4, 80A ( $t_p=5/50ns$ )
- Lightning, 8A (8/20μs as defined in IEC 61000-4-5 2<sup>nd</sup> edition)
- Low capacitance of 1pF (TYP) per I/O
- Low leakage current of 0.01μA (TYP) at 5V
- Small form factor μDFN (JEDEC MO-229) package provides flow through routing to simplify PCB layout
- AEC-Q101 qualified
- Moisture Sensitivity Level(MSL -1)
- Halogen free, lead free and RoHS compliant
- PPAP capable

### Applications

- LCD/PDP TVs
- External Storages
- DVD/Blu-ray Players
- Set Top Boxes
- Smartphones
- Ultrabooks/Notebooks
- Digital Cameras
- Portable Medical
- Automotive Electronics
- Wearable Technology

### USB 2.0 Protection Application Example

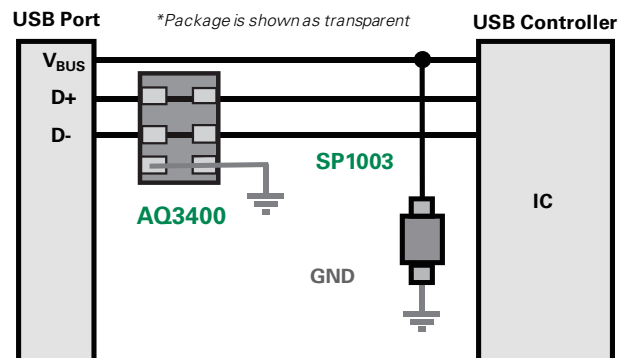

Life Support Note:

**Not Intended for Use in Life Support or Life Saving Applications**

The products shown herein are not designed for use in life sustaining or life saving applications unless otherwise expressly indicated.

**Absolute Maximum Ratings**

Symbol	Parameter	Value	Units
$I_{PP}$	Peak Current ( $t_p=8/20\mu s$ )	8	A
$T_{OP}$	Operating Temperature	-40 to 125	°C
$T_{STOR}$	Storage Temperature	-55 to 150	°C

CAUTION: Stresses above those listed in "Absolute Maximum Ratings" may cause permanent damage to the component. This is a stress only rating and operation of the component at these or any other conditions above those indicated in the operational sections of this specification is not implied.

**Electrical Characteristics ( $T_{OP}=25^\circ C$ )**

Parameter	Symbol	Test Conditions	Min	Typ	Max	Units
Reverse Standoff Voltage	$V_{RWM}$	$I_R = 1\mu A$			5.0	V
Breakdown Voltage	$V_{BR}$	$I_R = 1mA$	6.5	7.8		V
Reverse Leakage Current	$I_{LEAK}$	$V_R=5V$ , Any I/O to GND		0.01	0.5	$\mu A$
Clamp Voltage <sup>1</sup>	$V_C$	$I_{PP}=1A$ , $t_p=8/20\mu s$ , Fwd		9.2	12	V
		$I_{PP}=8A$ , $t_p=8/20\mu s$ , Fwd		13	16	V
Dynamic Resistance <sup>2</sup>	$R_{DYN}$	TLP; $t_p=100ns$ , I/O to GND		0.24		$\Omega$
ESD Withstand Voltage <sup>1</sup>	$V_{ESD}$	IEC 61000-4-2 (Contact)	$\pm 30$			kV
		IEC 61000-4-2 (Air)	$\pm 30$			kV
Diode Capacitance <sup>3</sup>	$C_{I/O-GND}$	Reverse Bias=0V, f= 3 GHz		1		$\mu F$
	$C_{I/O-I/O}$			0.5		

Note: 1 Parameter is guaranteed by design and/or component characterization.

2. Transmission Line Pulse (TLP) with 100ns width, 2ns rise time, and average window  $t_1=70ns$  to  $t_2= 90ns$ .

3. Package sizes larger than 0201 can add parasitic capacitance, inductance and resistance.

**8/20 $\mu s$  Pulse Waveform**

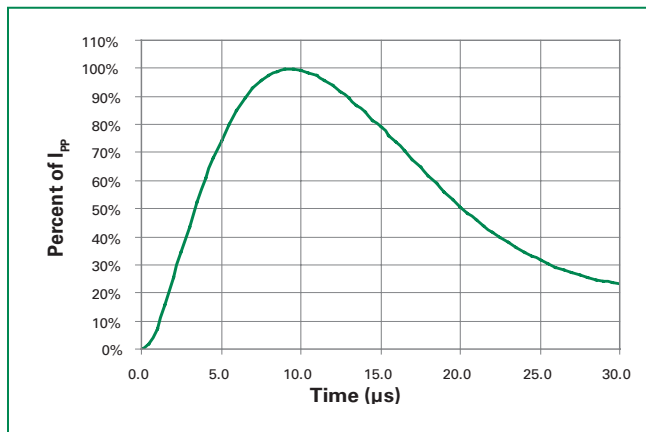

**Clamping voltage vs.  $I_{PP}$  for 8/20 $\mu s$  waveshape**

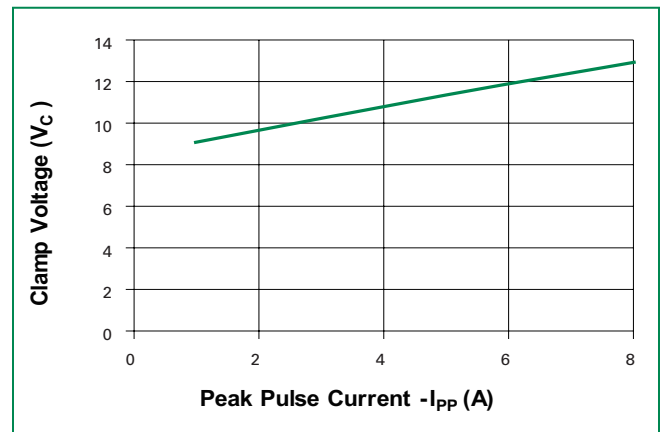

**Positive Transmission Line Pulsing (TLP) Plot**

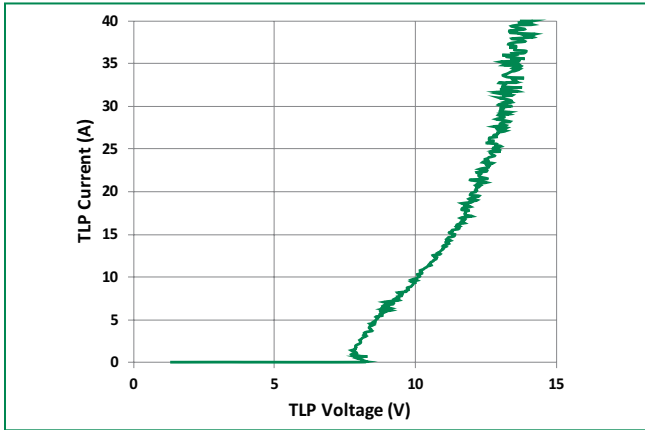

**Negative Transmission Line Pulsing (TLP) Plot**

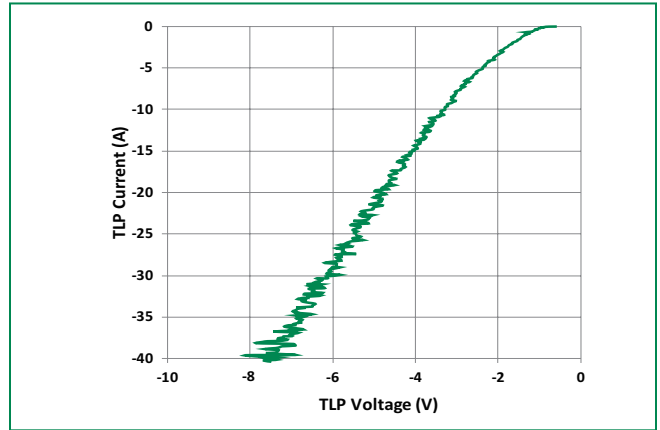

**IEC 61000-4-2 +8 kV Contact ESD Clamping Voltage**

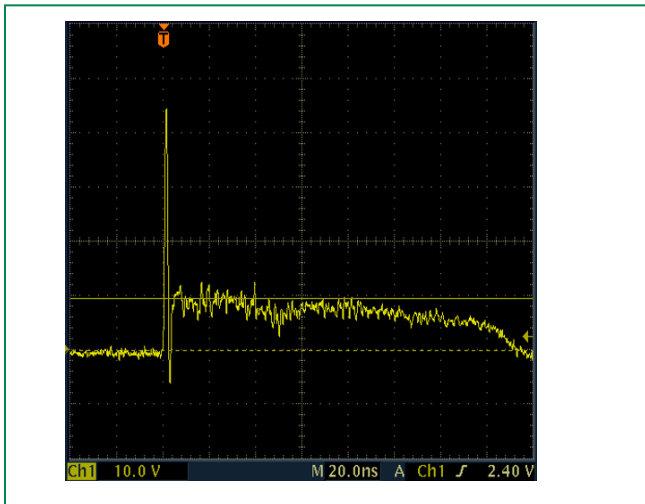

**IEC 61000-4-2 -8 kV Contact ESD Clamping Voltage**

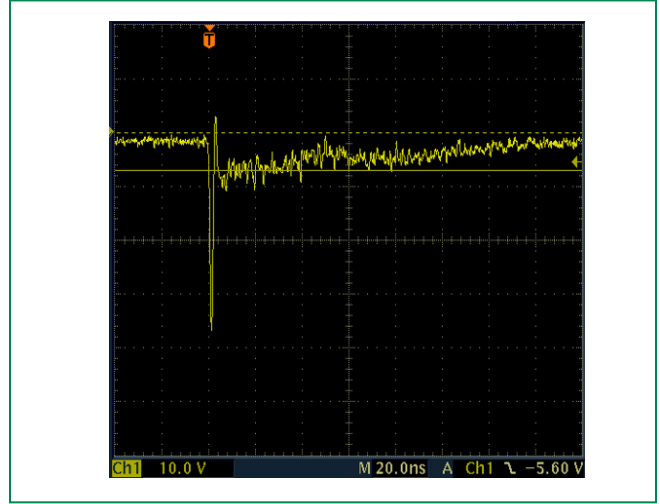

**ISO 10605 (C:330pF, R:330Ω) contact discharge plot at +8KV**

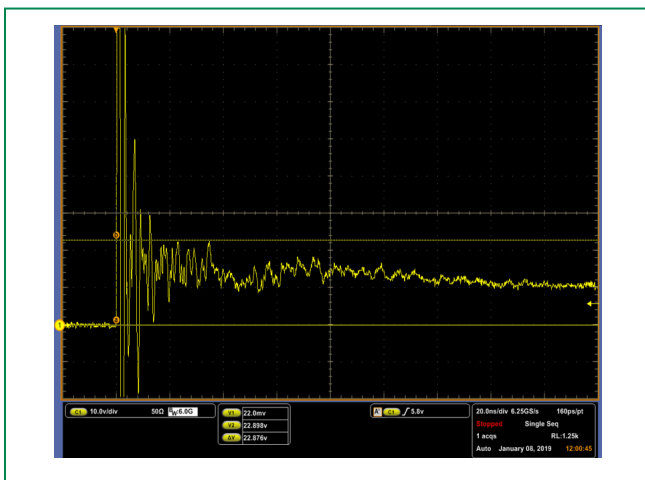

**ISO 10605 (C:330pF, R:330Ω) contact discharge plot at -8KV**

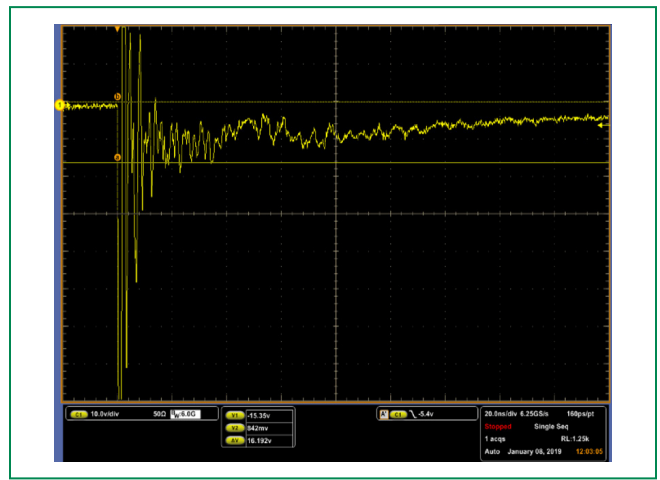

**Soldering Parameters**

Reflow Condition	Pb – Free assembly	
Pre Heat	- Temperature Min ( $T_{s(min)}$ )	150°C
	- Temperature Max ( $T_{s(max)}$ )	200°C
	- Time (min to max) ( $t_s$ )	60 – 180 secs
Average ramp up rate (Liquidus) Temp ( $T_L$ ) to peak	3°C/second max	
$T_{s(max)}$ to $T_L$ - Ramp-up Rate	3°C/second max	
Reflow	- Temperature ( $T_L$ ) (Liquidus)	217°C
	- Temperature ( $t_L$ )	60 – 150 seconds
Peak Temperature ( $T_p$ )	260 <sup>+0/-5</sup> °C	
Time within 5°C of actual peak Temperature ( $t_p$ )	20 – 40 seconds	
Ramp-down Rate	6°C/second max	
Time 25°C to peak Temperature ( $T_p$ )	8 minutes Max.	
Do not exceed	260°C	

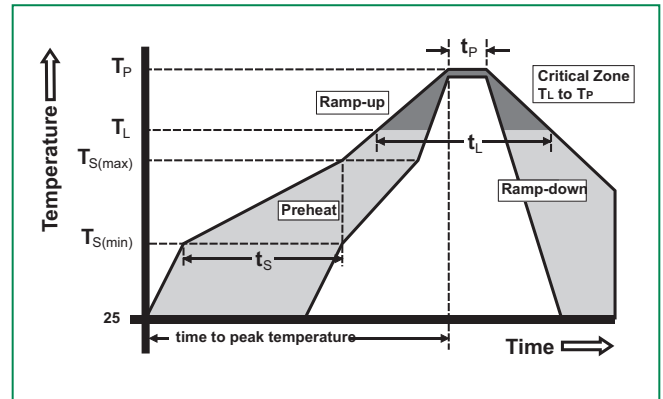

**Product Characteristics**

<b>Lead Plating</b>	Pre-Plated Frame (μDFN)
<b>Lead Material</b>	Copper Alloy
<b>Substrate Material</b>	Silicon
<b>Body Material</b>	Molded Compound
<b>Flammability</b>	UL Recognized compound meeting flammability rating V-0

**Part Numbering System**

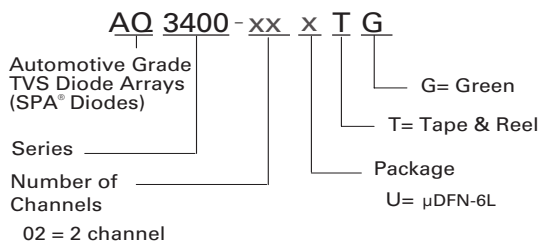

**Part Marking System**

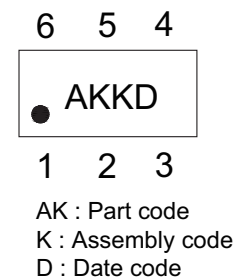

**Ordering Information**

Part Number	Package	Min. Order Qty.
AQ3400-02UTG	μDFN-6L	3000

**Package Dimensions — μDFN-6L**

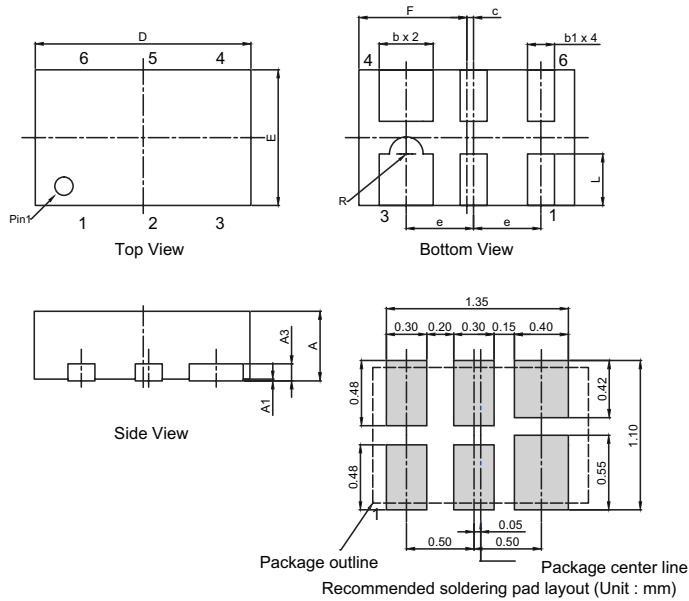

Drawing# : U03-A

Package	μDFN-6L			
JEDEC	MO-229			
Pins	6			
	Millimeters		Inches	
	Min	Max	Min	Max
<b>A</b>	0.45	0.55	0.018	0.022
<b>A1</b>	0.00	0.05	0.000	0.002
<b>A3</b>	0.125 REF		0.005 REF	
<b>b</b>	0.35	0.45	0.014	0.018
<b>b1</b>	0.15	0.25	0.006	0.010
<b>c</b>	0.05 REF		0.002 REF	
<b>D</b>	1.55	1.65	0.062	0.065
<b>E</b>	0.95	1.05	0.038	0.042
<b>F</b>	0.80 REF		0.031 REF	
<b>e</b>	0.50 REF		0.020 REF	
<b>R</b>	0.125 REF		0.005 REF	
<b>L</b>	0.33	0.43	0.013	0.017

**Embossed Carrier Tape & Reel Specification — μDFN-6L**

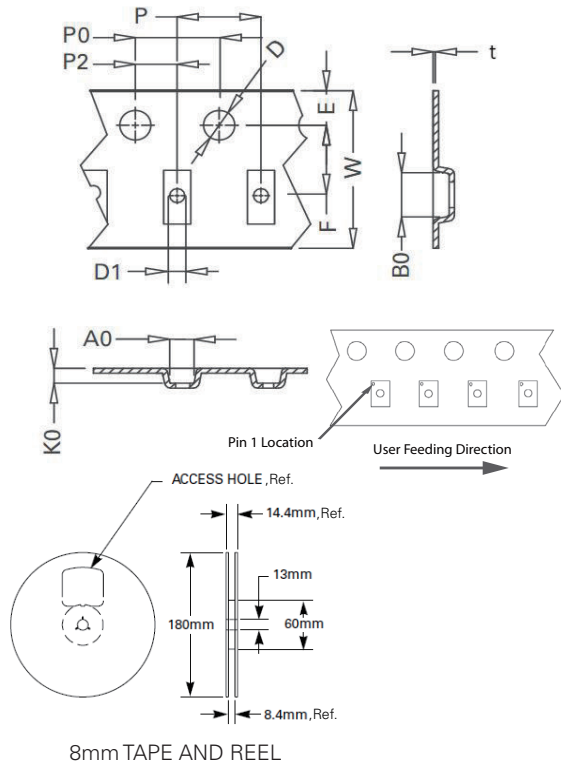

Symbol	Millimeters		Inches	
	Min	Max	Min	Max
<b>E</b>	1.65	1.85	0.064	0.073
<b>F</b>	3.45	3.55	0.135	0.139
<b>P2</b>	1.95	2.05	0.076	0.081
<b>D</b>	1.40	1.60	0.055	0.063
<b>D1</b>	0.45	0.55	0.017	0.021
<b>P</b>	3.90	4.10	0.154	0.161
<b>10P0</b>	40.0+/-0.20		1.574+/-0.008	
<b>W</b>	7.90	8.30	0.311	0.319
<b>P0</b>	3.90	4.10	0.154	0.161
<b>A0</b>	1.15	1.25	0.045	0.049
<b>B0</b>	1.75	1.85	0.069	0.073
<b>K0</b>	0.65	0.75	0.026	0.03
<b>t</b>	0.22 max		0.009 max	

8mm TAPE AND REEL

**Disclaimer Notice - Information furnished is believed to be accurate and reliable. However, users should independently evaluate the suitability of and test each product selected for their own applications. Littelfuse products are not designed for, and may not be used in, all applications.**

Read complete Disclaimer Notice at <http://www.littelfuse.com/disclaimer-electronics>.