

AQxx-02HTG Series

500W TVS Diode Array

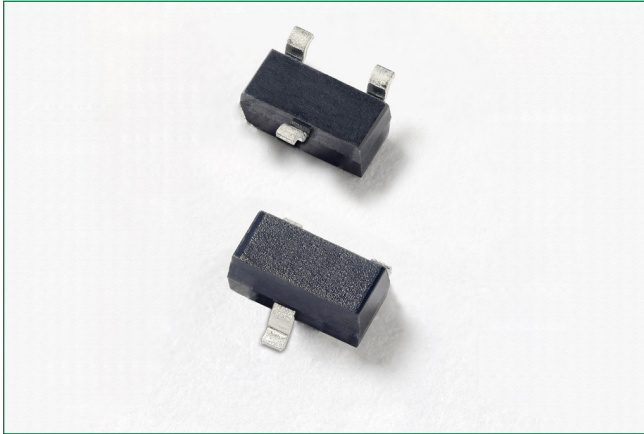

Description

The AQxx-02HTG Series TVS Diode Array is designed to protect sensitive equipment from damage due to electrostatic discharge (ESD), electrical fast transients (EFT), and lightning induced surges. This AQxx-02HTG series can safely absorb repetitive ESD strikes of ± 30 kV (contact and air discharge as defined in IEC 61000-4-2) without any performance degradation. Additionally, the AQ05 can safely conduct a 33A 8/20 surge event as defined in IEC 61000-4-5 2nd Edition at low voltage clamping levels.

Features & Benefits

- ESD, IEC 61000-4-2, ± 30 kV contact, ± 30 kV air
- EFT, IEC 61000-4-4, 50A (5/50ns)
- Lightning, 33A (8/20 μ s as defined in IEC 61000-4-5 2nd edition) for the AQ05
- Working voltages: 5V, 12V, 15V, 24V and 36V
- ESD, ISO 10605, 330pF 330 Ω , ± 30 kV contact, ± 30 kV air
- Low clamping voltage
- Low leakage current
- AEC-Q101 qualified
- Moisture Sensitivity Level (MSL -1)
- Halogen free, lead free and RoHS compliant
- PPAP capable

Pinout and Functional Block Diagram

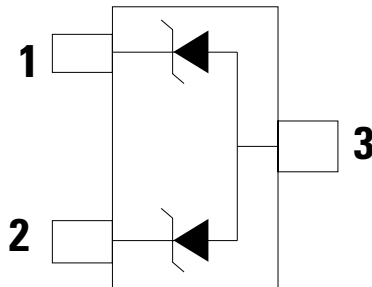

Applications

- Industrial Equipment
- Test and Medical Equipment
- Point-of-Sale Terminals
- Motor Controls
- Legacy Ports RS-232, RS-485
- Security and Alarm Systems

RS-232 Application Example

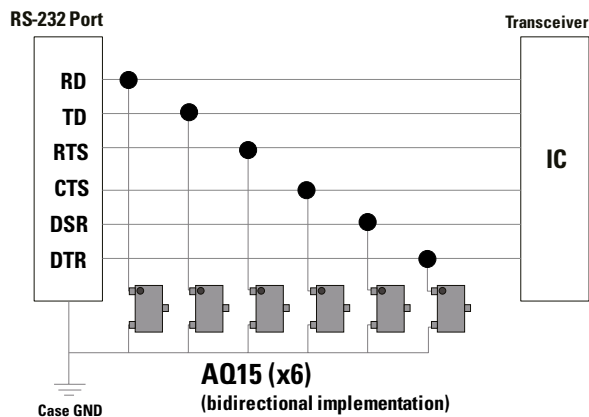

Life Support Note:

Not Intended for Use in Life Support or Life Saving Applications

The products shown herein are not designed for use in life sustaining or life saving applications unless otherwise expressly indicated.

AQxx-02HTG Series

500W TVS Diode Array

Absolute Maximum Ratings

Symbol	Parameter	Value	Units
P_{PK}	Peak Pulse Power ($t_p=8/20\mu s$)	500	W
T_{OP}	Operating Temperature	-40 to 150	°C
T_{STOR}	Storage Temperature	-55 to 150	°C

Caution: Stresses above those listed in "Absolute Maximum Ratings" may cause permanent damage to the component. This is a stress only rating and operation of the component at these or any other conditions above those indicated in the operational sections of this specification is not implied.

AQ05 Electrical Characteristics ($T_{OP}=25^\circ C$)

Parameter	Symbol	Test Conditions	Min	Typ	Max	Units
Reverse Standoff Voltage	V_{RWM}	$I_R=1\mu A$			5.0	V
Breakdown Voltage	V_{BR}	$I_R=1mA$	6.0	7.0		V
Reverse Leakage Current	I_{LEAK}	$V_R=5V$			1.0	μA
Clamp Voltage ¹	V_C	$I_{PP}=1A, t_p=8/20\mu s$, Pin 1 or Pin 2 to Pin 3		8.0	9.8	V
		$I_{PP}=10A, t_p=8/20\mu s$, Pin 1 or Pin 2 to Pin 3		10.5	13.0	V
Dynamic Resistance ²	R_{DYN}	TLP, $t_p=100ns$, Pin 1 or Pin 2 to Pin 3		0.19		Ω
Peak Pulse Current	I_{PP}	$t_p=8/20\mu s$			33	A
ESD Withstand Voltage ¹	V_{ESD}	IEC 61000-4-2 (Contact Discharge)	± 30			kV
		IEC 61000-4-2 (Air Discharge)	± 30			kV
Diode Capacitance ¹	$C_{I/O-GND}$	Reverse Bias=0V, f=1MHz		290	350	pF
	$C_{I/O-I/O}$	Reverse Bias=0V, f=1MHz		145	180	pF

AQ12 Electrical Characteristics ($T_{OP}=25^\circ C$)

Parameter	Symbol	Test Conditions	Min	Typ	Max	Units
Reverse Standoff Voltage	V_{RWM}	$I_R=1\mu A$			12.0	V
Breakdown Voltage	V_{BR}	$I_R=1mA$	13.3	14.2		V
Reverse Leakage Current	I_{LEAK}	$V_R=12V$			1.0	μA
Clamp Voltage ¹	V_C	$I_{PP}=1A, t_p=8/20\mu s$, Pin 1 or Pin 2 to Pin 3		16.0	18.5	V
		$I_{PP}=10A, t_p=8/20\mu s$, Pin 1 or Pin 2 to Pin 3		20.0	22.5	V
Dynamic Resistance ²	R_{DYN}	TLP, $t_p=100ns$, Pin 1 or Pin 2 to Pin 3		0.25		Ω
Peak Pulse Current	I_{PP}	$t_p=8/20\mu s$			20	A
ESD Withstand Voltage ¹	V_{ESD}	IEC 61000-4-2 (Contact Discharge)	± 30			kV
		IEC 61000-4-2 (Air Discharge)	± 30			kV
Diode Capacitance ¹	$C_{I/O-GND}$	Reverse Bias=0V, f=1MHz		110	135	pF
	$C_{I/O-I/O}$	Reverse Bias=0V, f=1MHz		55	85	pF

AQxx-02HTG Series

500W TVS Diode Array

AQ15 Electrical Characteristics (T_{op}=25°C)

Parameter	Symbol	Test Conditions	Min	Typ	Max	Units
Reverse Standoff Voltage	V _{RWM}	I _R =1μA			15.0	V
Breakdown Voltage	V _{BR}	I _R =1mA	16.7	18.5		V
Reverse Leakage Current	I _{LEAK}	V _R =15V			1.0	μA
Clamp Voltage ¹	V _C	I _{PP} =1A, t _p =8/20μs, Pin 1 or Pin 2 to Pin 3		20.5	24.0	V
		I _{PP} =10A, t _p =8/20μs, Pin 1 or Pin 2 to Pin 3		26.6	30.0	V
Dynamic Resistance ²	R _{DYN}	TLP, t _p =100ns, Pin 1 or Pin 2 to Pin 3		0.30		Ω
Peak Pulse Current	I _{PP}	t _p =8/20μs			15	A
ESD Withstand Voltage ¹	V _{ESD}	IEC 61000-4-2 (Contact Discharge)	±30			kV
		IEC 61000-4-2 (Air Discharge)	±30			kV
Diode Capacitance ¹	C _{I/O-GND}	Reverse Bias=0V, f=1MHz		85	100	pF
	C _{I/O-I/O}	Reverse Bias=0V, f=1MHz		45	75	pF

AQ24 Electrical Characteristics (T_{op}=25°C)

Parameter	Symbol	Test Conditions	Min	Typ	Max	Units
Reverse Standoff Voltage	V _{RWM}	I _R =1μA			24.0	V
Breakdown Voltage	V _{BR}	I _R =1mA	26.7	28		V
Reverse Leakage Current	I _{LEAK}	V _R =24V			1.0	μA
Clamp Voltage ¹	V _C	I _{PP} =1A, t _p =8/20μs, Pin 1 or Pin 2 to Pin 3		30.0	36.0	V
		I _{PP} =5A, t _p =8/20μs, Pin 1 or Pin 2 to Pin 3		36.0	42.0	V
Dynamic Resistance ²	R _{DYN}	TLP, t _p =100ns, Pin 1 or Pin 2 to Pin 3		0.50		Ω
Peak Pulse Current	I _{PP}	t _p =8/20μs			9	A
ESD Withstand Voltage ¹	V _{ESD}	IEC 61000-4-2 (Contact Discharge)	±30			kV
		IEC 61000-4-2 (Air Discharge)	±30			kV
Diode Capacitance ¹	C _{I/O-GND}	Reverse Bias=0V, f=1MHz		60	65	pF
	C _{I/O-I/O}	Reverse Bias=0V, f=1MHz		30	50	pF

AQ36 Electrical Characteristics (T_{op}=25°C)

Parameter	Symbol	Test Conditions	Min	Typ	Max	Units
Reverse Standoff Voltage	V _{RWM}	I _R =1μA			36.0	V
Breakdown Voltage	V _{BR}	I _R =1mA	40.0	41.8		V
Reverse Leakage Current	I _{LEAK}	V _R =36V			1.0	μA
Clamp Voltage ¹	V _C	I _{PP} =1A, t _p =8/20μs, Pin 1 or Pin 2 to Pin 3		45.0	52.0	V
		I _{PP} =5A, t _p =8/20μs, Pin 1 or Pin 2 to Pin 3		58.5	62.0	V
Dynamic Resistance ²	R _{DYN}	TLP, t _p =100ns, Pin 1 or Pin 2 to Pin 3		0.65		Ω
Peak Pulse Current	I _{PP}	t _p =8/20μs			7	A
ESD Withstand Voltage ¹	V _{ESD}	IEC 61000-4-2 (Contact Discharge)	±30			kV
		IEC 61000-4-2 (Air Discharge)	±30			kV
Diode Capacitance ¹	C _{I/O-GND}	Reverse Bias=0V, f=1MHz		45	50	pF
	C _{I/O-I/O}	Reverse Bias=0V, f=1MHz		25	40	pF

Note:
¹ Parameter is guaranteed by design and/or component characterization.

² Transmission Line Pulse (TLP) with 100ns width, 2ns rise time, and average window t1=70ns to t2= 90ns

AQxx-02HTG Series

500W TVS Diode Array

Capacitance vs. Reverse Bias (Pin1 or Pin2 to Pin3)

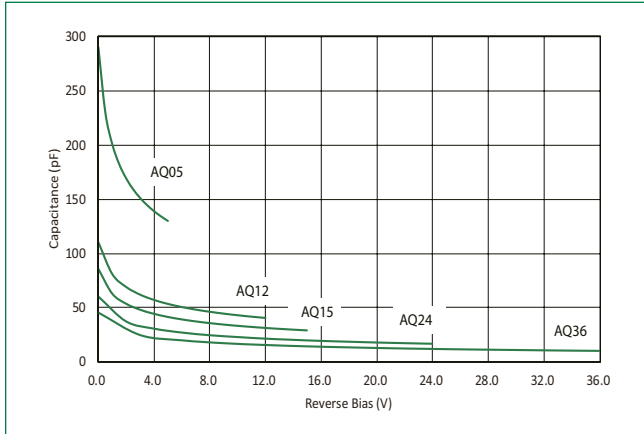

8/20μs Pulse Waveform

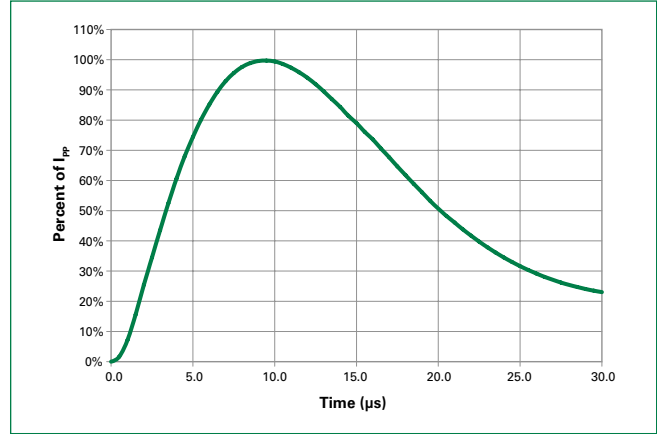

AQ05 Transmission Line Pulsing(TLP) Plot

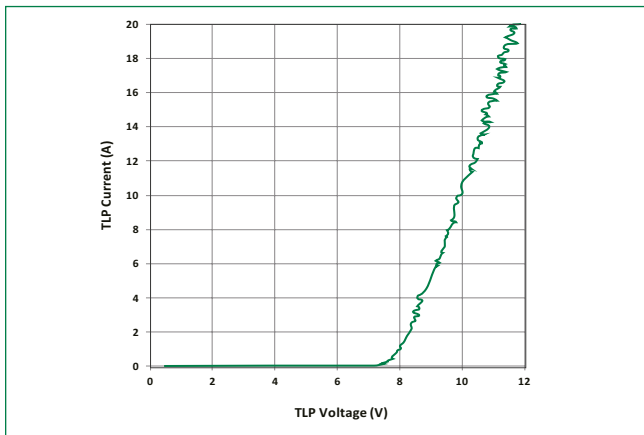

AQ12 Transmission Line Pulsing(TLP) Plot

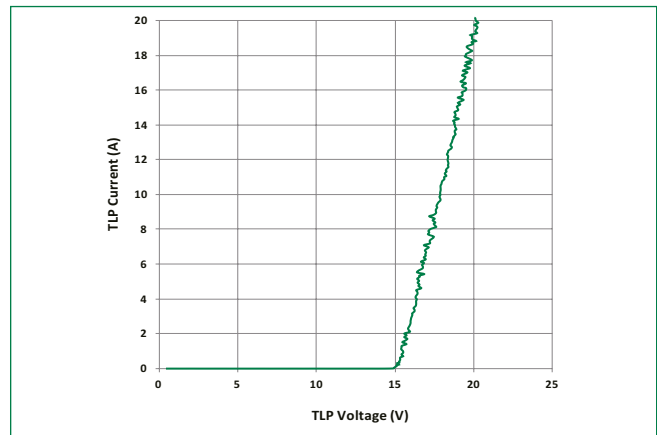

AQ15 Transmission Line Pulsing(TLP) Plot

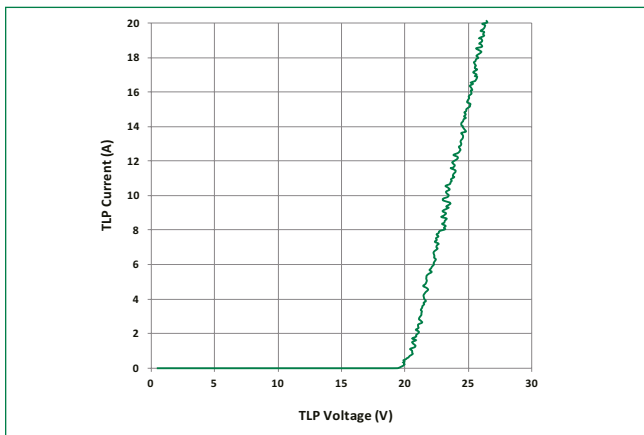

AQ24 Transmission Line Pulsing(TLP) Plot

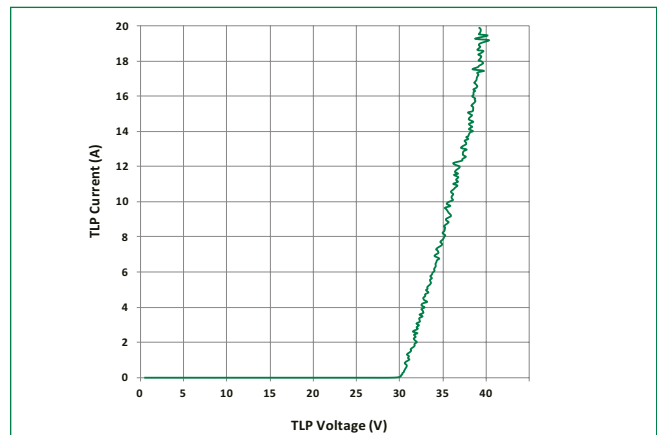

AQxx-02HTG Series

500W TVS Diode Array

AQ36 Transmission Line Pulsing (TLP) Plot

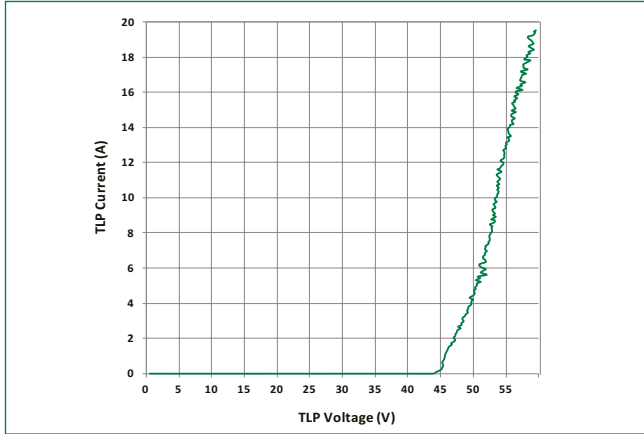

Power Derating Curve

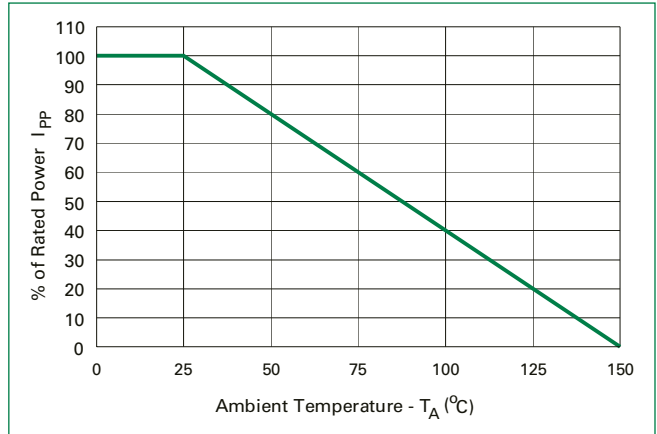

ISO10605 (C:330pF, R:330Ω) contact discharge plot at +8KV

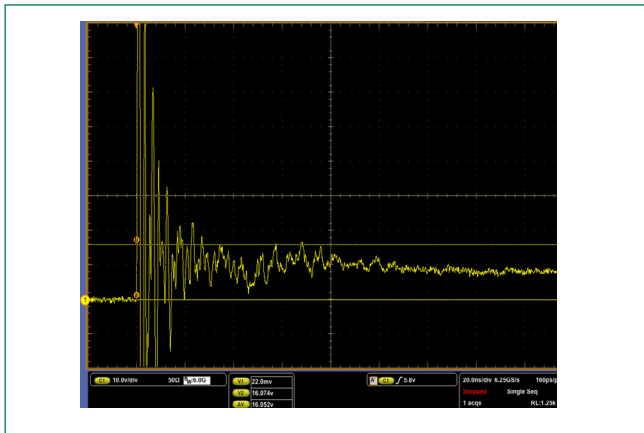

ISO10605 (C:330pF, R:330Ω) contact discharge plot at -8KV

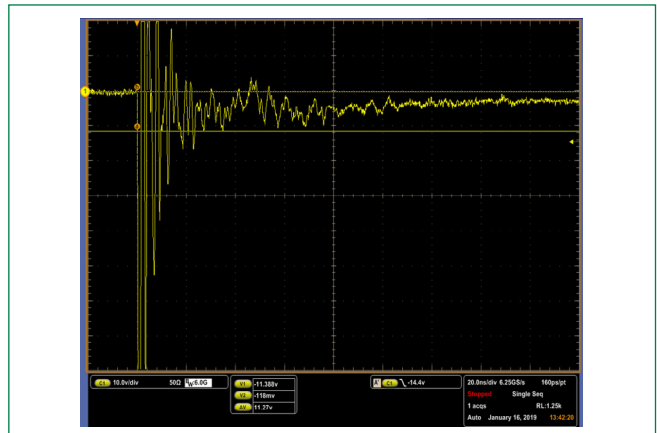

ISO10605 (C:330pF, R:330Ω) contact discharge plot at +8KV

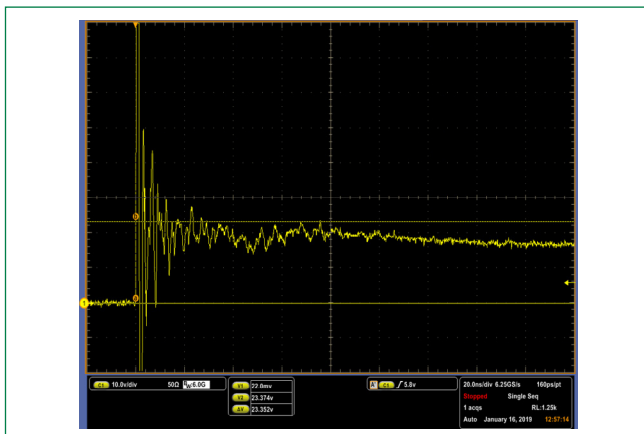

ISO10605 (C:330pF, R:330Ω) contact discharge plot at -8KV



AQxx-02HTG Series

500W TVS Diode Array

**ISO10605 (C:330pF, R:330Ω)
contact discharge plot at +8KV**

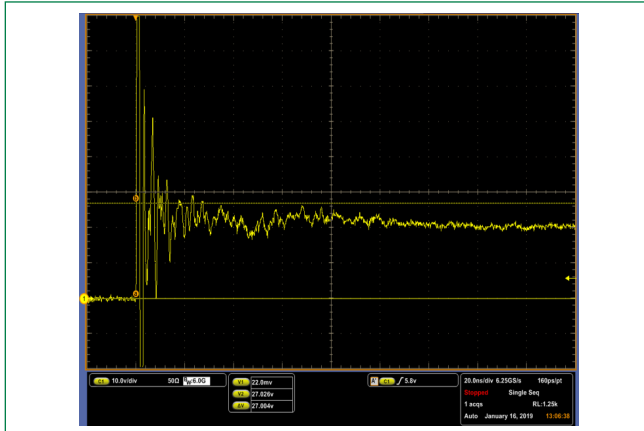

**ISO10605 (C:330pF, R:330Ω)
contact discharge plot at -8KV**

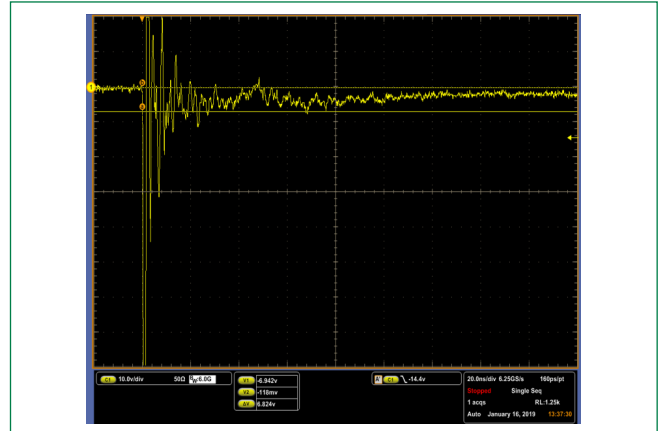

**ISO10605 (C:330pF, R:330Ω)
contact discharge plot at +8KV**

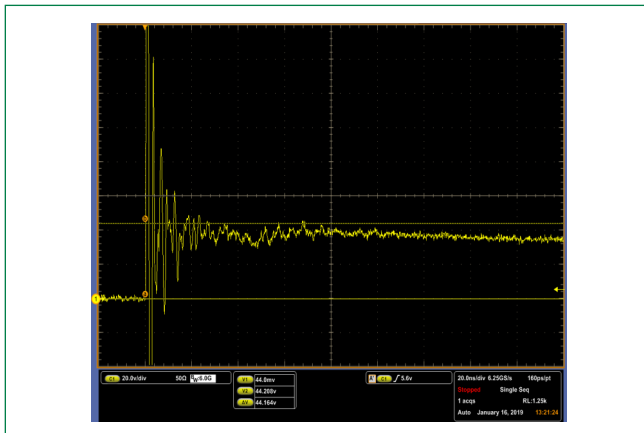

**ISO10605 (C:330pF, R:330Ω)
contact discharge plot at -8KV**

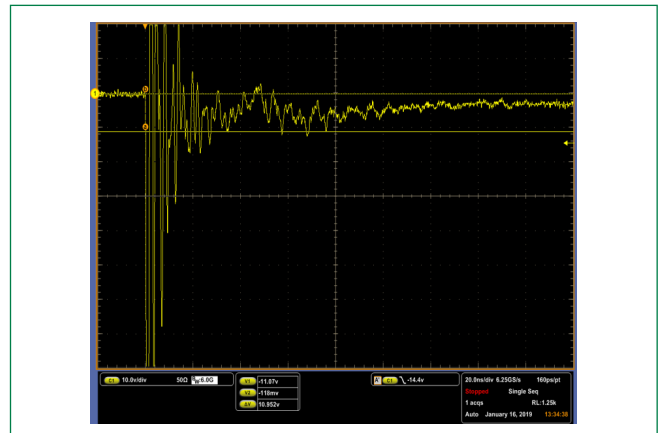

**ISO10605 (C:330pF, R:330Ω)
contact discharge plot at +8KV**

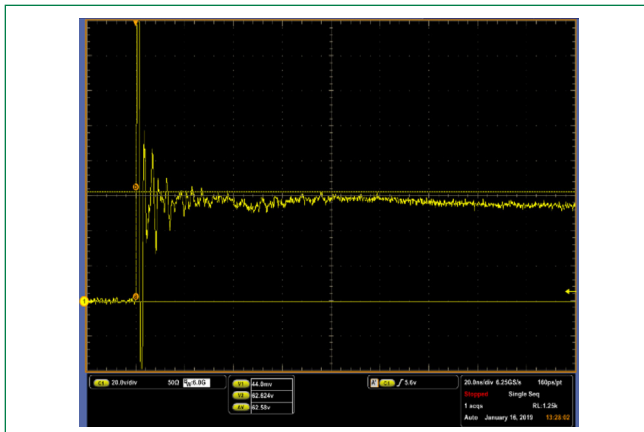

**ISO10605 (C:330pF, R:330Ω)
contact discharge plot at -8KV**



AQxx-02HTG Series

500W TVS Diode Array

Soldering Parameters

Reflow Condition		Pb – Free assembly
Pre Heat	- Temperature Min ($T_{s(min)}$)	150°C
	- Temperature Max ($T_{s(max)}$)	200°C
	- Time (min to max) (t_s)	60 – 120 secs
Average ramp up rate (Liquidus) Temp (T_L) to peak		3°C/second max
$T_{s(max)}$ to T_L - Ramp-up Rate		3°C/second max
Reflow	- Temperature (T_L) (Liquidus)	217°C
	- Temperature (t_L)	60 – 150 seconds
Peak Temperature (T_p)		260 ^{+0/-5} °C
Time within 5°C of actual peak Temperature (t_p)		30 seconds
Ramp-down Rate		6°C/second max
Time 25°C to peak Temperature (T_p)		8 minutes Max.
Do not exceed		260°C

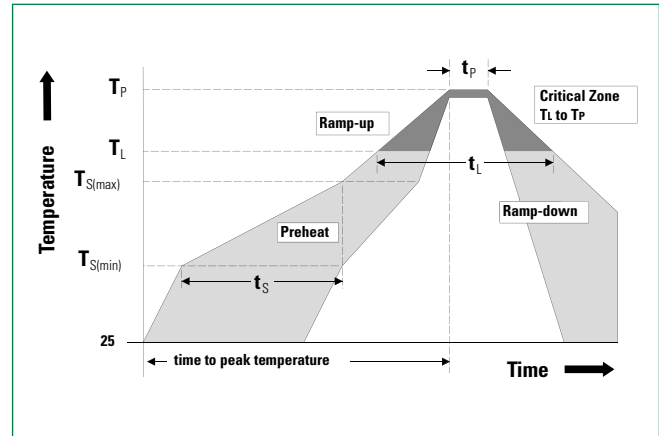

Ordering Information

Part Number	Package	Min. Order Qty.
AQ05-02HTG	SOT23-3	3000
AQ12-02HTG	SOT23-3	3000
AQ15-02HTG	SOT23-3	3000
AQ24-02HTG	SOT23-3	3000
AQ36-02HTG	SOT23-3	3000

Product Characteristics

Lead Plating	Matte Tin
Lead Material	Copper Alloy
Lead Coplanarity	0.004 inches(0.102mm)
Substrate Material	Silicon
Body Material	Molded Compound
Flammability	UL Recognized compound meeting flammability rating V-0

AQxx-02HTG Series

500W TVS Diode Array

Part Marking System

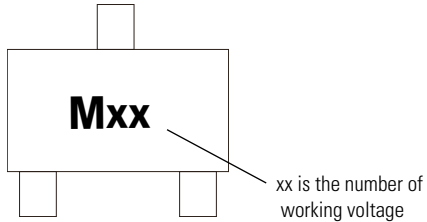

Part Numbering System

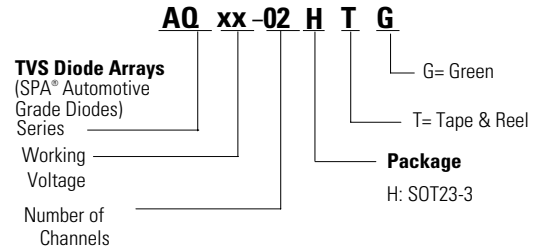

Package Dimensions – SOT23-3

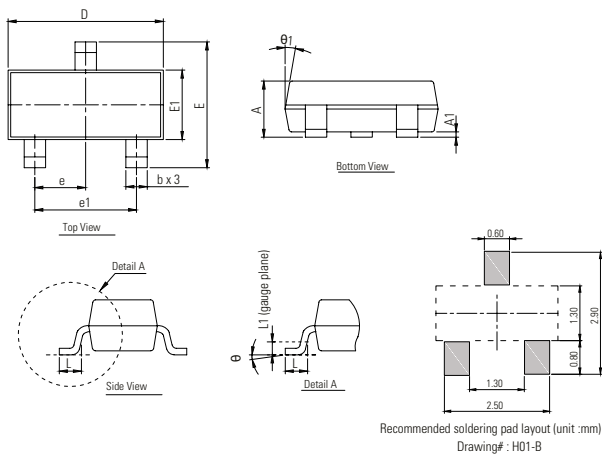

Symbol	Millimeters		Inches	
	Min	Max	Min	Max
A	0.90	1.11	0.035	0.044
A1	0.013	0.10	0.001	0.004
b	0.37	0.51	0.015	0.020
D	2.80	3.04	0.110	0.120
E	2.10	2.64	0.083	0.104
E1	1.20	1.40	0.047	0.055
e	0.95 BSC		0.037 BSC	
e1	1.90 BSC		0.075 BSC	
L	0.30	0.55	0.012	0.022
L1	0.25 BSC		0.010 BSC	
θ	0°	8°	0°	8°
θ_1	7° TYP		7° TYP	

Embossed Carrier Tape & Reel Specification – SOT23-3

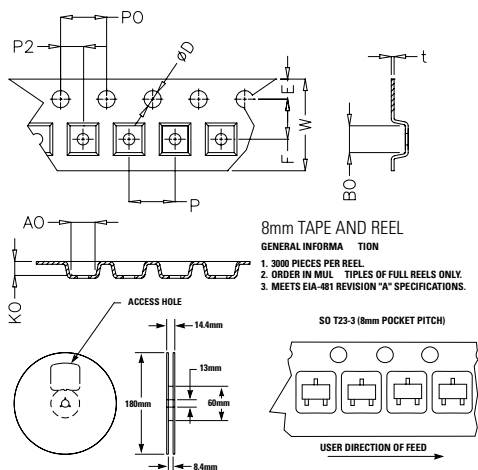

Symbol	Millimeters		Inches	
	Min	Max	Min	Max
E	1.65	1.85	0.065	0.073
F	3.40	3.60	0.134	0.142
P2	1.90	2.10	0.075	0.083
D	1.40	1.60	0.055	0.063
P0	3.90	4.10	0.154	0.161
W	7.70	8.30	0.303	0.327
P	3.90	4.10	0.154	0.161
A0	3.05	3.25	0.120	0.128
B0	2.67	2.87	0.105	0.113
K0	1.12	1.32	0.044	0.052
t	0.22	0.24	0.009	0.009

Disclaimer Notice - Information furnished is believed to be accurate and reliable. However, users should independently evaluate the suitability of and test each product selected for their own applications. Littelfuse products are not designed for, and may not be used in, all applications. Read complete Disclaimer Notice at <http://www.littelfuse.com/disclaimer-electronics>.