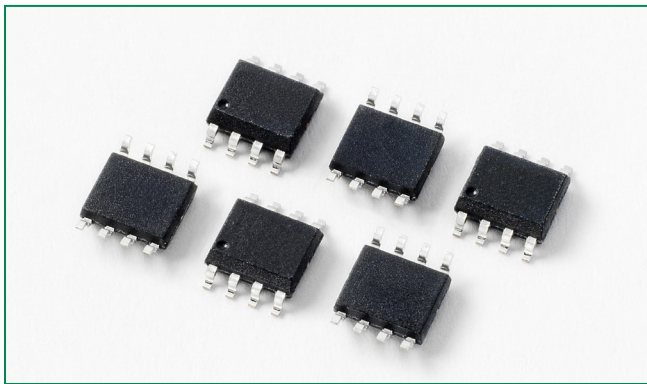


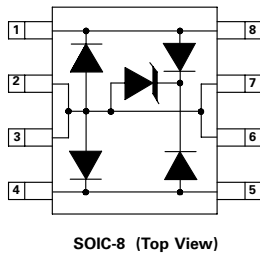
**LC03-3.3 Series 3.3V 150A Diode Array**



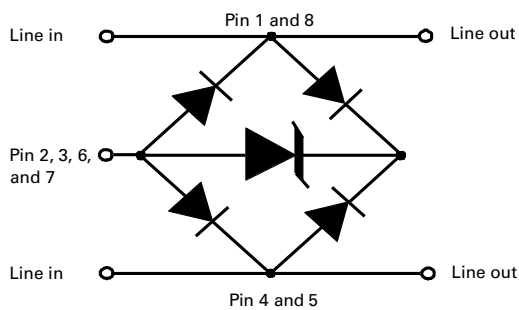
**Description**

This LC03-3.3 series provides overvoltage protection for applications such as 10/100/1000 BaseT Ethernet and T3/E3 interfaces. This new protector combines the TVS diode element with a diode rectifier bridge to provide both longitudinal and differential protection in one package. This design results in a capacitive loading characteristic that is log-linear with respect to the signal voltage across the device. This reduces intermodulation (IM) distortion caused by a typical solid-state protection solution. The application schematic provides the connection information and the LC03-3.3 is rated for GR-1089, intra-building transient immunity requirements for telecommunication installations.

**Pinout**



**Functional Block Diagram**



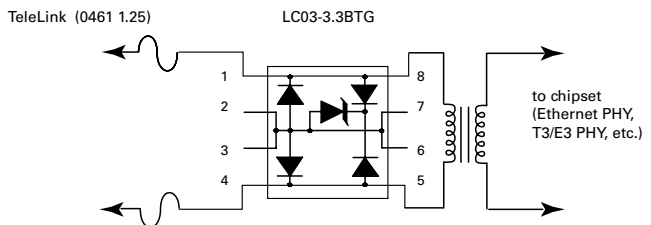
**Features**

- Lightning Protection, IEC 61000-4-5 2nd edition, 150A ( $t_P=8/20\mu s$ )
- EFT, IEC 61000-4-4, 40A ( $t_P=5/50ns$ )
- Low insertion loss, log-linear capacitance
- Low clamping voltage
- SOIC-8 surface mount package (JEDEC MS-012)
- UL 94V-0 epoxy molding
- RoHS and Lead-free compliant
- Moisture Sensitivity Level (MSL-1)

**Applications**

- T1/E1 Line cards
- T3/E3 and DS3 Interfaces
- STS-1 Interfaces
- 10/100/1000 BaseT Ethernet

**Application Example**



This schematic shows a high-speed data interface protection solution. The LC03-3.3BTG is compatible with the intra-building surge requirements of Telcordia's GR-1089-CORE, and the Basic Level Recommendations of ITU K.20 and K.21. The TeleLink fuse provides overcurrent protection for the long term 50/60 Hz power fault events.

**Additional Information**



Resources



Samples

Life Support Note:

**Not Intended for Use in Life Support or Life Saving Applications**

The products shown herein are not designed for use in life sustaining or life saving applications unless otherwise expressly indicated.

**Absolute Maximum Ratings**

Parameter	Rating	Units
Peak Pulse Current (8/20μs)	150	A
Peak Pulse Power (8/20μs)	3300	W
IEC 61000-4-2, Direct Discharge, (Level 4)	30	kV
IEC 61000-4-2, Air Discharge, (Level 4)	30	kV
IEC 61000-4-5 (8/20μs)	150	A
Telcordia GR 1089 (Intra-Building) (2/10μs)	100	A
ITU K.20 (5/310μs)	40	A

CAUTION: Stresses above those listed in "Absolute Maximum Ratings" may cause permanent damage to the device. This is a stress only rating and operation of the device at these or any other conditions above those indicated in the operational sections of this specification is not implied.

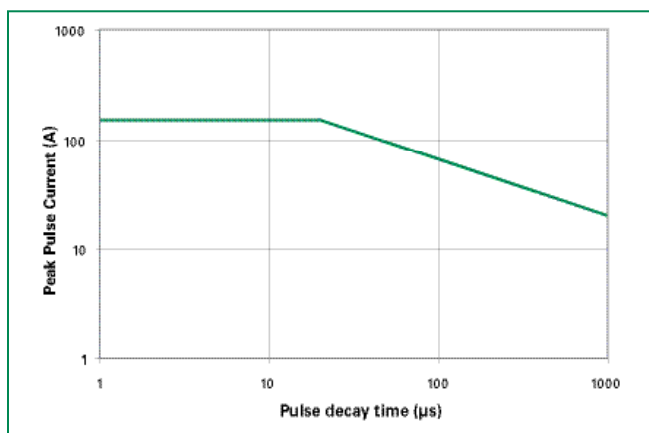
**Thermal Information**

Parameter	Rating	Units
SOIC Package	170	°C/W
Operating Temperature Range	-40 to 125	°C
Storage Temperature Range	-55 to 150	°C
Maximum Junction Temperature	150	°C
Maximum Lead Temperature (Soldering 20-40s) (SOIC - Lead Tips Only)	260	°C

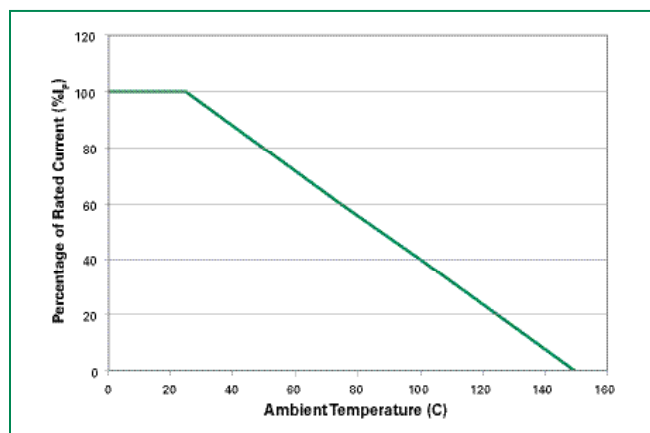
**Electrical Characteristics (T<sub>OP</sub> = 25°C)**

Parameter	Symbol	Test Conditions	Min	Typ	Max	Units
Reverse Stand-Off Voltage	V <sub>RWM</sub>	I <sub>T</sub> ≤ 1μA	-	-	3.3	V
Reverse Breakdown Voltage	V <sub>BR</sub>	I <sub>T</sub> = 2μA	3.3	-	-	V
Snap Back Voltage	V <sub>SB</sub>	I <sub>T</sub> = 50mA	3.3	-	-	V
Reverse Leakage Current	I <sub>R</sub>	V <sub>RWM</sub> = 3.3V, T = 25°C	-	-	1	μA
Clamping Voltage, Line-Ground	V <sub>C</sub>	I <sub>pp</sub> = 50A, t <sub>p</sub> = 8/20 μs	-	-	13	V
Clamping Voltage, Line-Ground	V <sub>C</sub>	I <sub>pp</sub> = 100A, t <sub>p</sub> = 8/20 μs	-	-	17	V
Dynamic Resistance, Line-Ground	R <sub>DYN</sub>	(V <sub>C2</sub> - V <sub>C1</sub> ) / (I <sub>PP2</sub> - I <sub>PP1</sub> )	-	0.15	-	Ω
Clamping Voltage, Line-Line	V <sub>C</sub>	I <sub>pp</sub> = 50A, t <sub>p</sub> = 8/20 μs	-	-	15	V
Clamping Voltage, Line-Line	V <sub>C</sub>	I <sub>pp</sub> = 100A, t <sub>p</sub> = 8/20 μs	-	-	20	V
Dynamic Resistance, Line-Line	R <sub>DYN</sub>	(V <sub>C2</sub> - V <sub>C1</sub> ) / (I <sub>PP2</sub> - I <sub>PP1</sub> )	-	0.25	-	Ω
Junction Capacitance	C <sub>j</sub>	Between I/O Pins and Ground V <sub>R</sub> = 0V, f = 1MHz	-	9	12	pF
		Between I/O Pins V <sub>R</sub> = 0V, f = 1MHz	-	4.5	6	pF

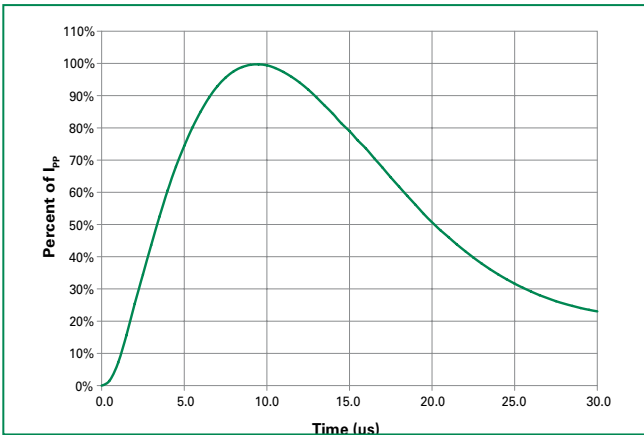
**Figure 1: Non-repetitive Peak Pulse Current vs. Pulse Time**



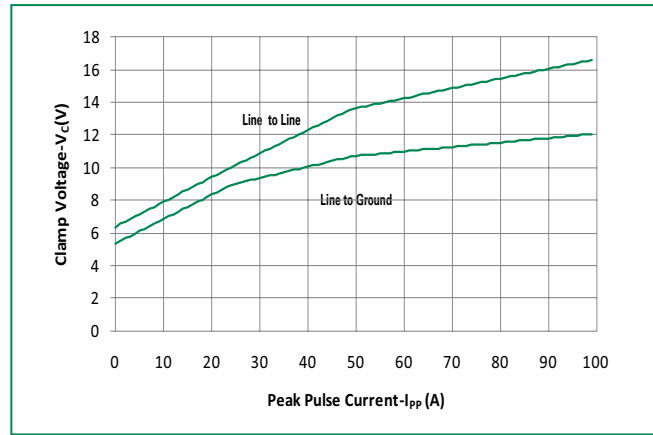
**Figure 2: Current Derating Curve**



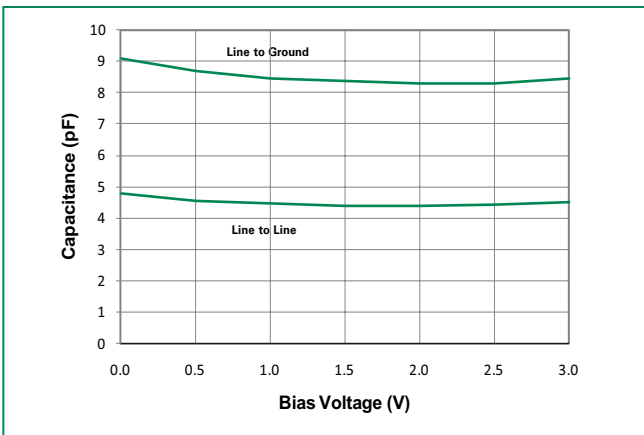
**Figure 3: 8/20  $\mu$ s Pulse Waveform**



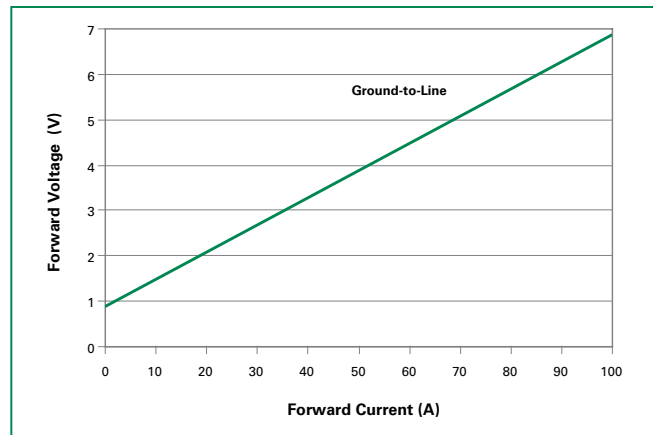
**Figure 4: Clamp Voltage vs. Peak Pulse Current**



**Figure 5: Capacitance vs. Reverse Voltage**

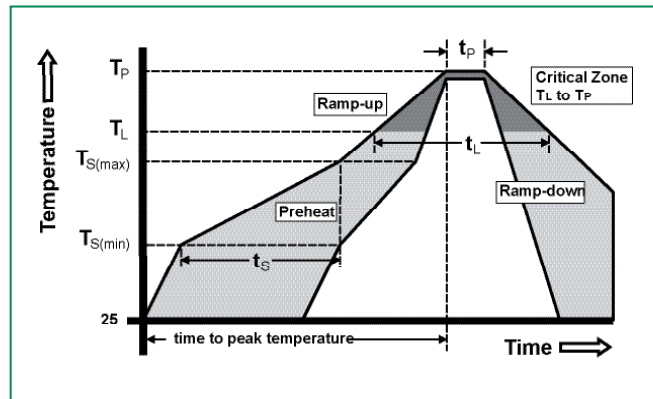


**Figure 6: Forward Voltage vs. Forward Current**

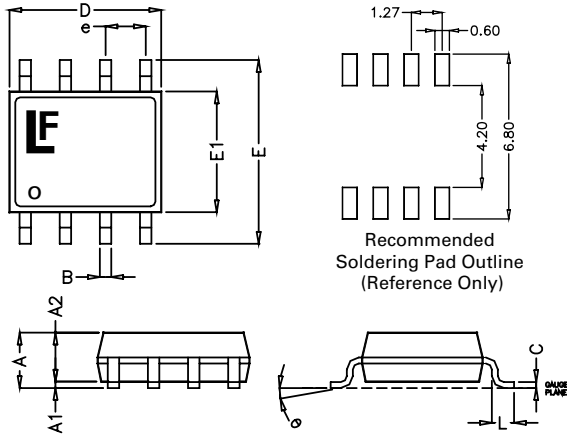


**Soldering Parameters**

Reflow Condition		Pb – Free assembly
Pre Heat	- Temperature Min ( $T_{s(min)}$ )	150°C
	- Temperature Max ( $T_{s(max)}$ )	200°C
	- Time (min to max) ( $t_s$ )	60 – 180 secs
Average ramp up rate (Liquidus) Temp ( $T_L$ ) to peak		3°C/second max
$T_{s(max)}$ to $T_L$ - Ramp-up Rate		3°C/second max
Reflow	- Temperature ( $T_L$ ) (Liquidus)	217°C
	- Temperature ( $t_L$ )	60 – 150 seconds
Peak Temperature ( $T_p$ )		260 <sup>+0/-5</sup> °C
Time within 5°C of actual peak Temperature ( $t_p$ )		20 – 40 seconds
Ramp-down Rate		6°C/second max
Time 25°C to peak Temperature ( $T_p$ )		8 minutes Max.
Do not exceed		260°C

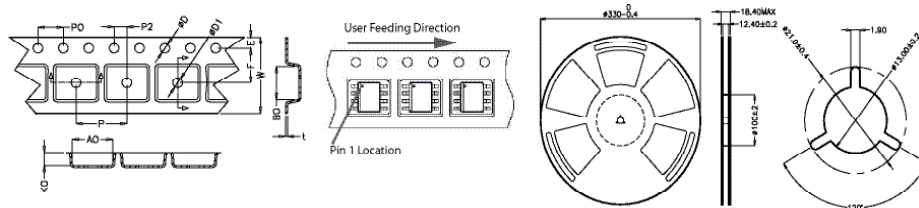


**Package Dimensions – Mechanical Drawings and Recommended Solder Pad Outline**



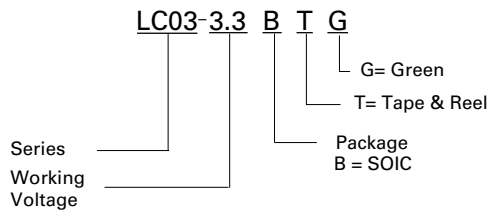
Package	SOIC-8			
Pins	8			
JEDEC	MS-012			
	Millimetres		Inches	
	Min	Max	Min	Max
<b>A</b>	1.35	1.75	0.053	0.069
<b>A1</b>	0.10	0.25	0.004	0.010
<b>A2</b>	1.25	1.65	0.050	0.065
<b>B</b>	0.31	0.51	0.012	0.020
<b>c</b>	0.17	0.25	0.007	0.010
<b>D</b>	4.80	5.00	0.189	0.197
<b>E</b>	5.80	6.20	0.228	0.244
<b>E1</b>	3.80	4.00	0.150	0.157
<b>e</b>	1.27 BSC		0.050 BSC	
<b>L</b>	0.40	1.27	0.016	0.050

**Embossed Carrier Tape & Reel Specification – SOIC Package**

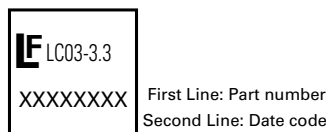


	Millimetres		Inches	
	Min	Max	Min	Max
<b>E</b>	1.65	1.85	0.065	0.073
<b>F</b>	5.4	5.6	0.213	0.22
<b>P2</b>	1.95	2.05	0.077	0.081
<b>D</b>	1.5	1.6	0.059	0.063
<b>D1</b>	1.50 Min		0.059 Min	
<b>P0</b>	3.9	4.1	0.154	0.161
<b>10P0</b>	40.0 ± 0.20		1.574 ± 0.008	
<b>W</b>	11.9	12.1	0.468	0.476
<b>P</b>	7.9	8.1	0.311	0.319
<b>A0</b>	6.3	6.5	0.248	0.256
<b>B0</b>	5.1	5.3	0.2	0.209
<b>K0</b>	2	2.2	0.079	0.087
<b>t</b>	0.30 ± 0.05		0.012 ± 0.002	

**Part Numbering System**



**Part Marking System**



**Ordering Information**

Part Number	Package	Marking	Min. Order Qty.
LC03-3.3BTG	SOIC-8	LC03-3.3	2500

**Product Characteristics**

<b>Lead Plating</b>	Matte Tin
<b>Lead Material</b>	Copper Alloy
<b>Lead Coplanarity</b>	0.004 inches (0.102mm)
<b>Substitute Material</b>	Silicon
<b>Body Material</b>	Molded Epoxy
<b>Flammability</b>	UL 94 V-0

Notes :

- All dimensions are in millimeters
- Dimensions include solder plating.
- Dimensions are exclusive of mold flash & metal burr.
- Blo is facing up for mold and facing down for trim/form, i.e. reverse trim/form.
- Package surface matte finish VDI 11-13.

**Disclaimer Notice - Information furnished is believed to be accurate and reliable. However, users should independently evaluate the suitability of and test each product selected for their own applications. Littelfuse products are not designed for, and may not be used in, all applications. Read complete Disclaimer Notice at [www.littelfuse.com/disclaimer-electronics](http://www.littelfuse.com/disclaimer-electronics).**