

# SC1006-01LTG

## 6V, 30kV, 5A, SOD523, Unidirectional TVS, General Purpose ESD protection

**HF** **RoHS** **Pb**

**Note:** This package image is for example and reference only. For detail package drawing, please refer to the package section in this datasheet.

### Web Resources



Download ECAD models, order samples, and find technical resources at [www.littelfuse.com](http://www.littelfuse.com)

### Description

The SC1006-01LTG unidirectional TVS is fabricated in a proprietary silicon avalanche technology. These diodes provide a high ESD (electrostatic discharge) protection level for electronic equipment. The SC1006-01LTG TVS can safely absorb repetitive ESD strikes of  $\pm 30$  kV (contact and air discharge as defined in IEC 61000-4-2) without any performance degradation. In addition, it can safely dissipate a 5A 8/20 $\mu$ s surge event as defined in IEC 61000-4-5, 2<sup>nd</sup> edition.

### Features & Benefits

- ESD, IEC 61000-4-2,  $\pm 30$ kV contact/air
- EFT, IEC 61000-4-4, 40A (5/50ns)
- Maximum surge tolerance, IEC 61000-4-5, 2<sup>nd</sup> Edition, 5A (8/20 $\mu$ s)
- Low leakage current of 0.5 $\mu$ A (MAX) at 6V
- Halogen-free, lead-free and RoHS compliant
- Moisture Sensitivity Level (MSL-1)

### Applications

- Power tools
- PDAs
- Power tools
- Portable medical components
- Portable navigation components
- Battery protection

#### Pinout



#### Functional Block Diagram

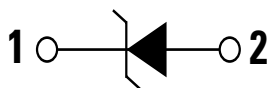

#### Life Support Note:

Not Intended for Use in Life Support or Life Saving Applications

The products shown herein are not designed for use in life sustaining or life saving applications unless otherwise expressly indicated.

**SC1006-01LTG**

6V, 30kV, 5A, SOD523, Unidirectional TVS, General Purpose ESD protection

**Absolute Maximum Ratings**

Symbol	Parameter	Value	Units
$I_{PP}$	Peak Current ( $t_p=8/20\mu s$ )	5	A
$T_{OP}$	Operating Temperature	-40 to 125	°C
$T_{STOR}$	Storage Temperature	-55 to 150	°C

**Caution:** Stresses above those listed in "Absolute Maximum Ratings" may cause permanent damage to the component. This is a stress only rating and operation of the component at these or any other conditions above those indicated in the operational sections of this specification is not implied.

**Electrical Characteristics ( $T_{OP}=25^\circ C$ )**

Parameter	Symbol	Test Conditions	Min	Typ	Max	Units
Reverse Standoff Voltage	$V_{RWM}$				6	V
Breakdown Voltage	$V_{BR}$	$I_R=1mA$		7.0		V
Forward Voltage Drop	$V_F$	$I_F=1mA$		0.8		V
Reverse Leakage Current	$I_{LEAK}$	$V_R=6V$			0.5	$\mu A$
Clamp Voltage <sup>1</sup>	$V_C$	$I_{pp}=1A, t_p=8/20\mu s, I/O$ to GND		8.5		V
		$I_{pp}=5A, t_p=8/20\mu s, I/O$ to GND		10.5		V
Dynamic Resistance <sup>1</sup>	$R_{DYN}$	$(V_C2-V_C1)/(I_{pp2}-I_{pp1}), I/O$ to GND		0.55		$\Omega$
ESD Withstand Voltage <sup>1,3</sup>	$V_{ESD}$	IEC 61000-4-2 (Contact Discharge)	$\pm 30$			kV
		IEC 61000-4-2 (Air Discharge)	$\pm 30$			kV
Diode Capacitance <sup>1</sup>	$C_{IO-GND}$	Reverse Bias=0V, $f=1MHz, I/O$ to GND		30		pF

**Note:**

- Parameter is guaranteed by design and/or device characterization.
- Transmission Line Pulse (TLP) with 100ns width, 0.2ns rise time, and average window  $t1=70ns$  to  $t2=90ns$
- Device stressed with ten non-repetitive ESD pulses.

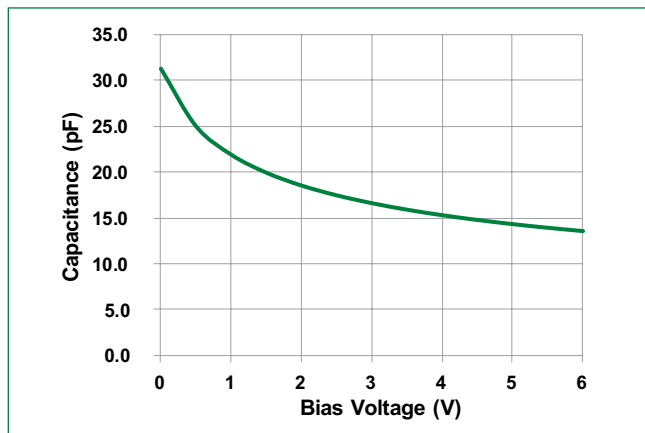
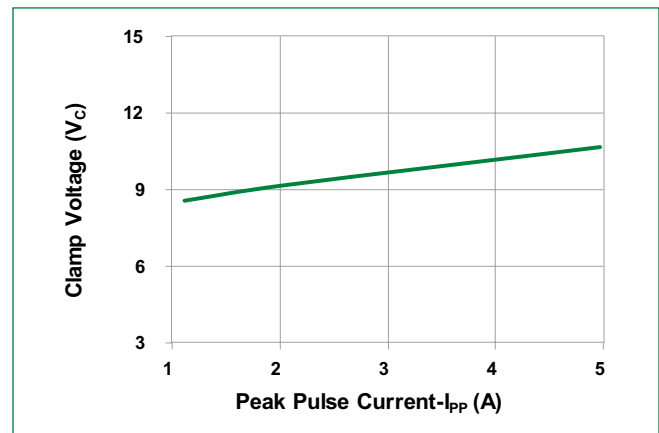
**Capacitance vs. Reverse Bias****Clamping Voltage vs  $I_{PP}$** 

# SC1006-01LTG

6V, 30kV, 5A, SOD523, Unidirectional TVS, General Purpose ESD protection

**Positive Transmission Line Pulsing (TLP) Plot**

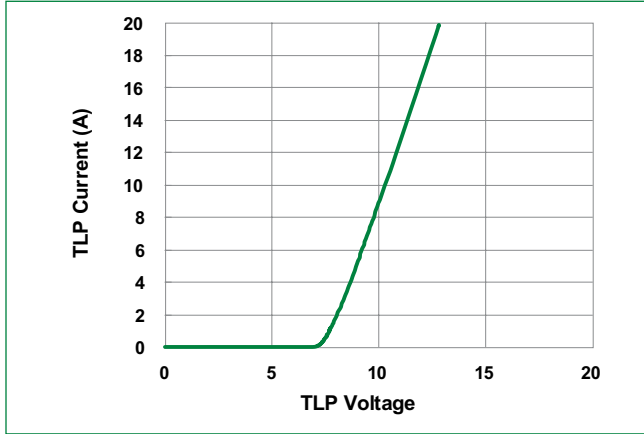

**Negative Transmission Line Pulsing (TLP) Plot**

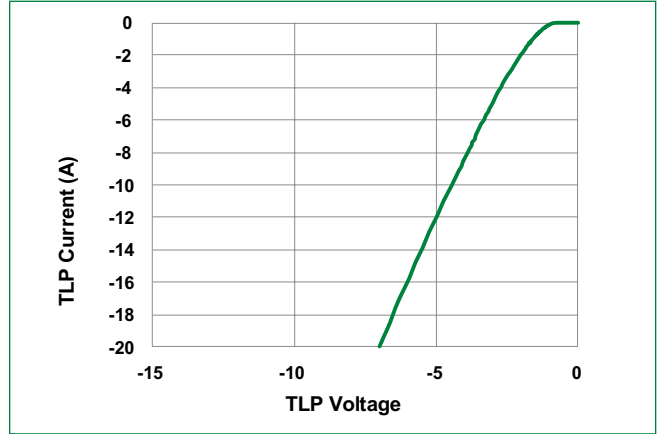

**IEC 61000-4-2 +8 kV Contact ESD Clamping Voltage**



**IEC 61000-4-2 -8 kV Contact ESD Clamping Voltage**

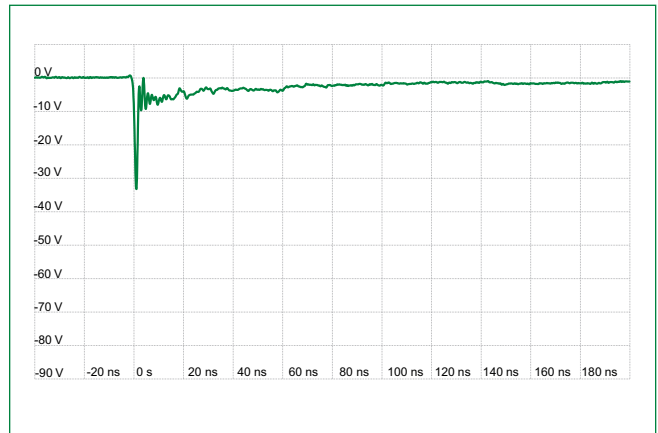

**8/20µs Pulse Waveform**

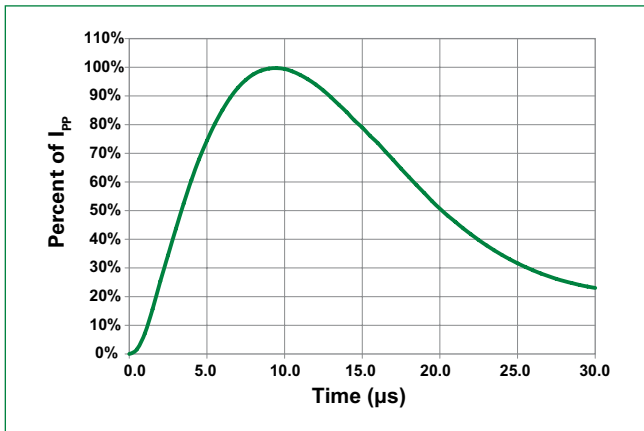

**SC1006-01LTG**

6V, 30kV, 5A, SOD523, Unidirectional TVS, General Purpose ESD protection

**Soldering Parameters**

<b>Reflow Condition</b>		Pb – Free assembly
<b>Pre Heat</b>	- Temperature Min ( $T_{s(min)}$ )	150°C
	- Temperature Max ( $T_{s(max)}$ )	200°C
	- Time (min to max) ( $t_s$ )	60 – 120 secs
<b>Average ramp up rate (Liquidus) Temp (<math>T_L</math>) to peak</b>		3°C/second max
<b><math>T_{s(max)}</math> to <math>T_L</math> - Ramp-up Rate</b>		3°C/second max
<b>Reflow</b>	- Temperature ( $T_L$ ) (Liquidus)	217°C
	- Temperature ( $t_L$ )	60 – 150 seconds
<b>Peak Temperature (<math>T_p</math>)</b>		260 <sup>+0/-5</sup> °C
<b>Time within 5°C of actual peak Temperature (<math>t_p</math>)</b>		30 seconds
<b>Ramp-down Rate</b>		6°C/second max
<b>Time 25°C to peak Temperature (<math>T_p</math>)</b>		8 minutes Max.
<b>Do not exceed</b>		260°C

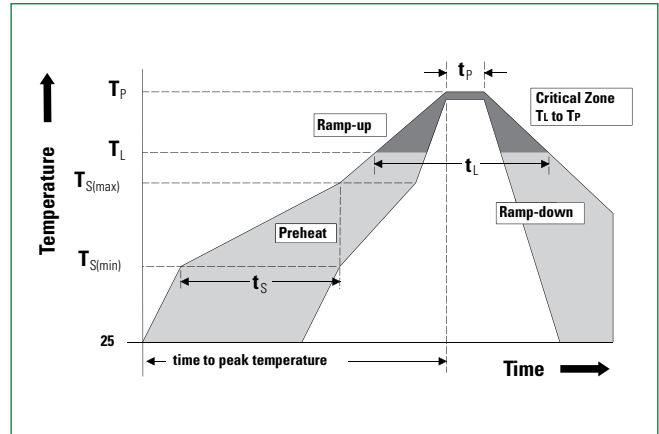
**Ordering Information**

Part Number	Package	Min. Order Qty.
SC1006-01LTG	SOD523	5,000

**Product Characteristics**

<b>Lead Plating</b>	Matte Tin
<b>Lead material</b>	Copper Alloy
<b>Lead Coplanarity</b>	0.0004 inches (0.102mm)
<b>Substrate Material</b>	Silicon
<b>Body Material</b>	Molded Compound
<b>Flammability</b>	UL Recognized compound meeting flammability rating V-0

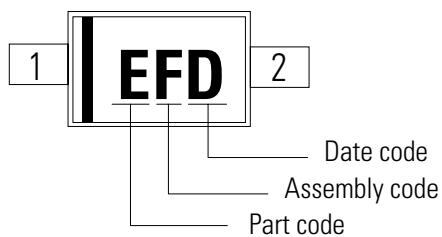
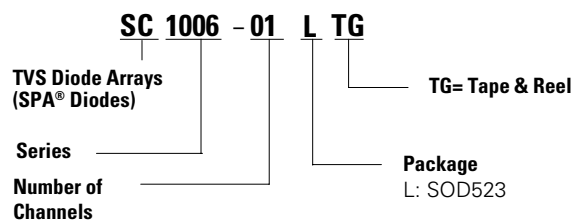
**Part Marking System****Part Numbering System**

**SC1006-01LTG**

6V, 30kV, 5A, SOD523, Unidirectional TVS, General Purpose ESD protection

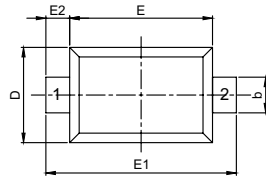
**Package Dimensions — SOD523**

Top View

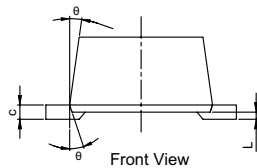

Front View

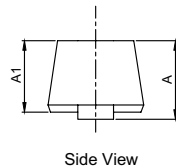

Side View

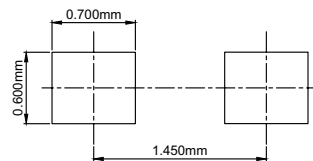

Recommended Soldering Pad Layout

Symbol	Millimeters		Inches	
	Min	Max	Min	Max
<b>A</b>	0.51	0.77	0.020	0.030
<b>A1</b>	0.50	0.70	0.020	0.028
<b>b</b>	0.25	0.35	0.010	0.014
<b>c</b>	0.08	0.15	0.003	0.006
<b>D</b>	0.70	0.90	0.028	0.035
<b>E</b>	1.10	1.30	0.043	0.051
<b>E1</b>	1.50	1.70	0.059	0.067
<b>E2</b>	0.20 REF		0.001 REF	
<b>L</b>	0.01	0.07	0.000	0.003
<b>θ</b>	7° REF		7° REF	

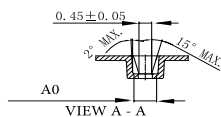
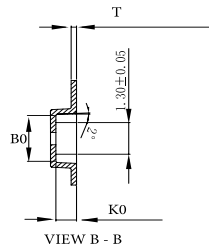
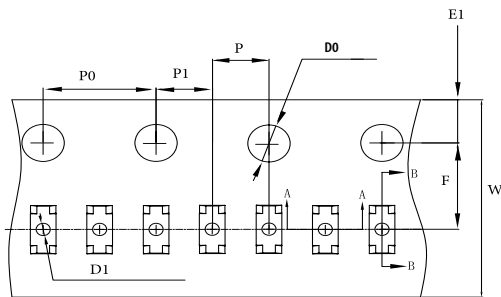
**Embossed Carrier Tape & Reel Specification — SOD523**

Component Orientation in Tape

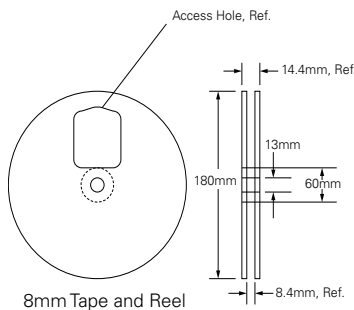
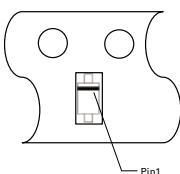

8mm Tape and Reel

Symbol	Millimeters
<b>A0</b>	0.85min/1.01max
<b>B0</b>	1.91+/-0.08
<b>W</b>	8.0+0.3/-0.10
<b>D0</b>	1.50+0.10
<b>D1</b>	∅1.00min/∅1.25max
<b>E1</b>	1.75+/-0.10
<b>F</b>	3.50+/-0.05
<b>P0</b>	4.00+/-0.10
<b>P</b>	2.00+/-0.05
<b>P1</b>	2.00+/-0.05
<b>K0</b>	0.68min/0.78max
<b>T</b>	0.254+/-0.13

**Product Disclaimer:** Littelfuse products are not designed for, and shall not be used for, any purpose (including, without limitation, automotive, military, aerospace, medical, life-saving, life-sustaining or nuclear facility applications, devices intended for surgical implant into the body, or any other application in which the failure or lack of desired operation of the product may result in personal injury, death, or property damage) other than those expressly set forth in applicable Littelfuse product documentation. Warranties granted by Littelfuse shall be deemed void for products used for any purpose not expressly set forth in applicable Littelfuse documentation. Littelfuse shall not be liable for any claims or damages arising out of products used in applications not expressly intended by Littelfuse as set forth in applicable Littelfuse documentation. The sale and use of Littelfuse products is subject to Littelfuse Terms and Conditions of Sale, unless otherwise agreed by Littelfuse. "Littelfuse" includes Littelfuse, Inc., and all of its affiliate entities. <http://www.littelfuse.com/disclaimer-electronics>.