

SC1533-01LTG

Bidirectional 3.3V, 15A, SOD523, General purpose ESD Protection

HF **RoHS** **Pb**

Note: This package image is for example and reference only. For detail package drawing, please refer to the package section in this datasheet.

Web Resources



Download ECAD models, order samples, and find technical resources at www.littelfuse.com

Pinout



Functional Block Diagram



Description

The SC1533-01LTG bidirectional TVS is fabricated in a proprietary silicon avalanche technology. These diodes provide a high ESD (electrostatic discharge) protection level for electronic equipment. The SC1533-01LTG TVS can safely absorb repetitive ESD strikes of $\pm 30\text{kV}$ (contact and air discharge as defined in IEC 61000-4-2) without any performance degradation. In addition, it can safely dissipate a 15A 8/20 μs surge event as defined in IEC 61000-4-5, 2nd Edition.

Features & Benefits

- ESD, IEC 61000-4-2, $\pm 30\text{kV}$ contact/air
- EFT, IEC 61000-4-4, 40A (5/50ns)
- Maximum surge tolerance, IEC 61000-4-5 2nd Edition, 15A (8/20 μs)
- Halogen free, lead free and RoHS compliant
- Moisture Sensitivity Level (MSL-1)

Applications

- Appliance
- Battery Protection
- Computer Peripherals
- Medical Equipment
- Notebooks / Desktops / Servers
- Point-of-Sale Terminals
- Switches / Buttons
- Test Equipment/ Instrumentation

Life Support Note:

Not Intended for Use in Life Support or Life Saving Applications

The products shown herein are not designed for use in life sustaining or life saving applications unless otherwise expressly indicated.

SC1533-01LTG

Bidirectional 3.3V, 15A, SOD523, General purpose ESD Protection

Absolute Maximum Ratings

Symbol	Parameter	Value	Units
I_{PP}	Peak Current ($t_p=8/20\mu s$)	15	A
T_{OP}	Operating Temperature	-40 to 125	°C
T_{STOR}	Storage Temperature	-55 to 150	°C

Caution: Stresses above those listed in "Absolute Maximum Ratings" may cause permanent damage to the component. This is a stress only rating and operation of the component at these or any other conditions above those indicated in the operational sections of this specification is not implied.

Electrical Characteristics ($T_{OP}=25^\circ C$)

Parameter	Symbol	Test Conditions	Min	Typ	Max	Units
Reverse Standoff Voltage	V_{RWM}	-	-	-	3.3	V
Breakdown Voltage	V_{BR}	$I_R=1mA$, I/O to GND	4.5	5.5	-	V
Reverse Leakage Current	I_{LEAK}	$V_R=3.3V$, I/O to GND	-	20	50	nA
Clamp Voltage ¹	V_C	$I_{PP}=1A$, $t_p=8/20\mu s$, I/O to GND	-	6.8	-	V
		$I_{PP}=15A$, $t_p=8/20\mu s$, I/O to GND	-	10.5	-	V
Dynamic Resistance ²	R_{DYN}	TLP, $t_p=100ns$, I/O to GND	-	0.11	-	Ω
ESD Withstand Voltage ¹	V_{ESD}	IEC 61000-4-2 (Contact Discharge)	± 30	-	-	kV
		IEC 61000-4-2 (Air Discharge)	± 30	-	-	kV
Diode Capacitance ¹	C_{IO-GND}	Reverse Bias=0V, $f=1MHz$, I/O to GND	-	25	-	pF

Note:

- Parameter is guaranteed by design and/or component characterization.
- Transmission Line Pulse (TLP) with 100ns width, 0.2ns rise time, and average window $t_1=70ns$ to $t_2=90ns$.
- Device stressed with ten non-repetitive ESD pulses.

Capacitance vs Reverse Bias

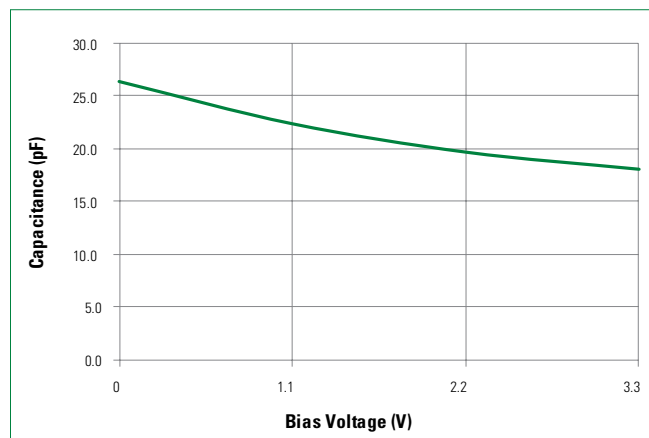

Clamping Voltage vs IPP

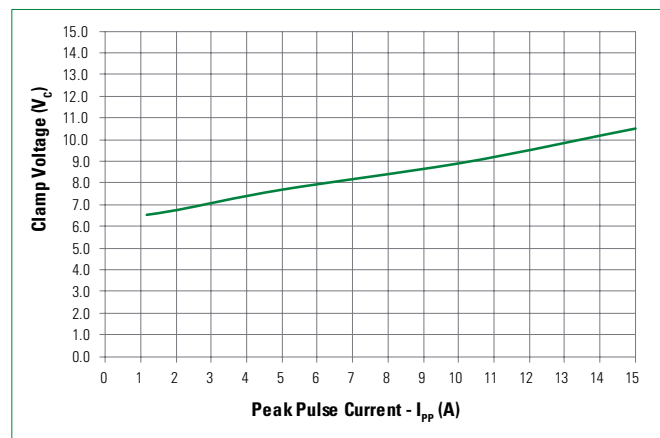

SC1533-01LTG

Bidirectional 3.3V, 15A, SOD523, General purpose ESD Protection

Positive Transmission Line Pulsing (TLP) Plot

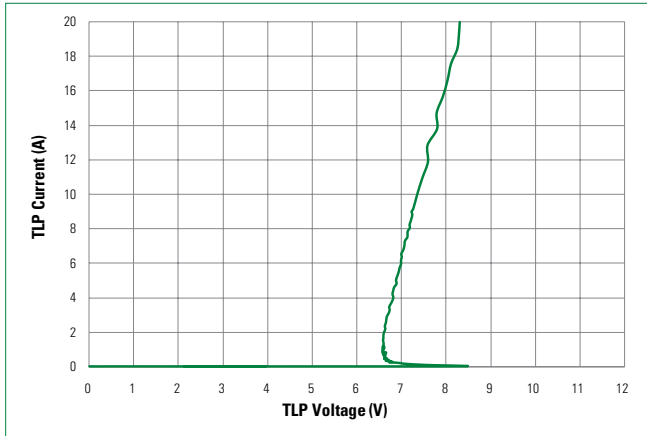

Negative Transmission Line Pulsing (TLP) Plot

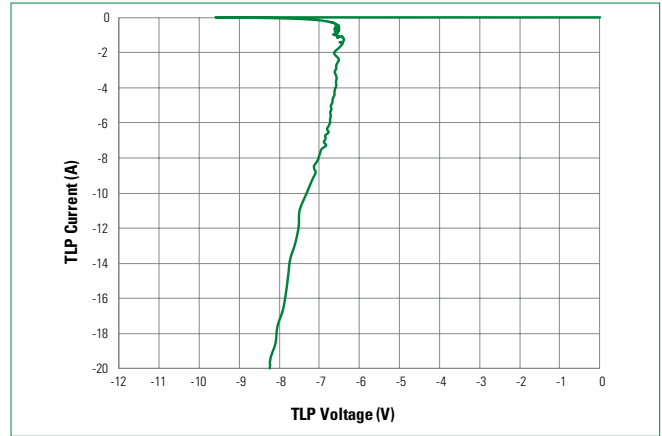

IEC 61000-4-2 +8 kV Contact ESD Clamping Voltage



IEC 61000-4-2 -8 kV Contact ESD Clamping Voltage

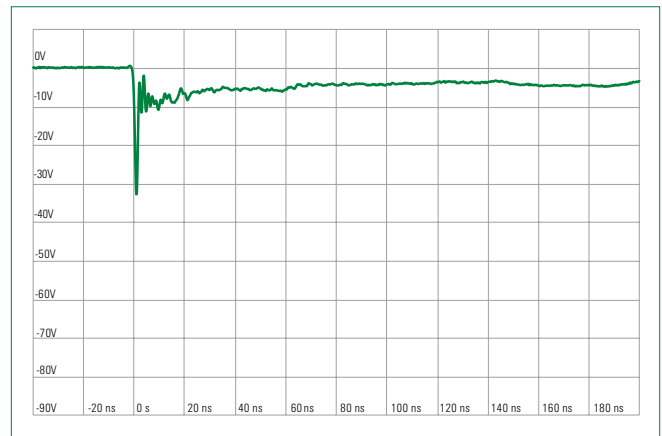

SC1533-01LTG

Bidirectional 3.3V, 15A, SOD523, General purpose ESD Protection

Soldering Parameters

Reflow Condition		Pb – Free assembly
Pre Heat	- Temperature Min ($T_{s(min)}$)	150°C
	- Temperature Max ($T_{s(max)}$)	200°C
	- Time (min to max) (t_s)	60 – 120 secs
Average ramp up rate (Liquidus) Temp (T_L) to peak		3°C/second max
$T_{s(max)}$ to T_L - Ramp-up Rate		3°C/second max
Reflow	- Temperature (T_L) (Liquidus)	217°C
	- Temperature (t_L)	60 – 150 seconds
Peak Temperature (T_p)		260 ^{+0/-5} °C
Time within 5°C of actual peak Temperature (t_p)		30 seconds
Ramp-down Rate		6°C/second max
Time 25°C to peak Temperature (T_p)		8 minutes Max.
Do not exceed		260°C

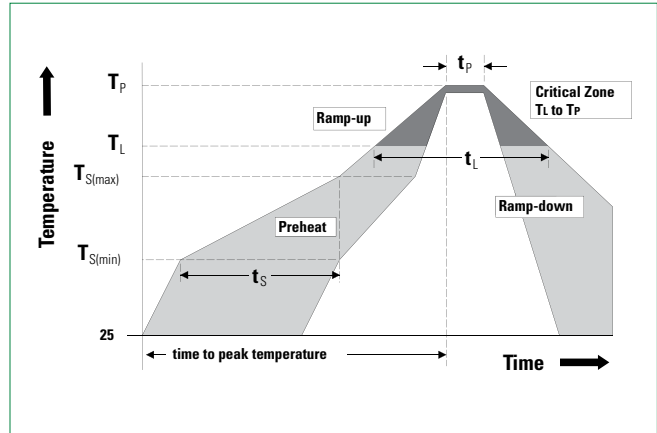
**Ordering Information**

Part Number	Package	Min. Order Qty.
SC1533-01LTG	SOD523	5,000

Product Characteristics

Lead Plating	Matte Tin
Lead material	Copper Alloy
Lead Coplanarity	0.0004 inches (0.102mm)
Body Material	Molded Compound
Flammability	UL Recognized compound meeting flammability rating V-0

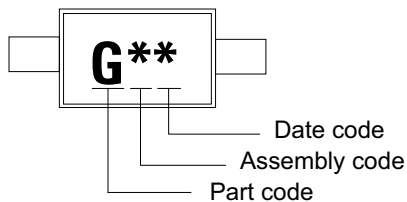
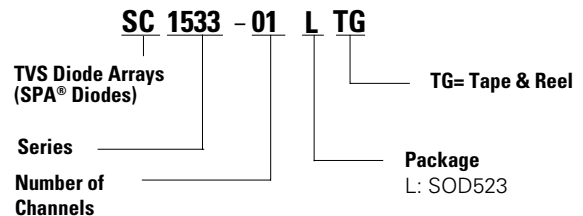
Part Marking System**Part Numbering System**

SC1533-01LTG

Bidirectional 3.3V, 15A, SOD523, General purpose ESD Protection

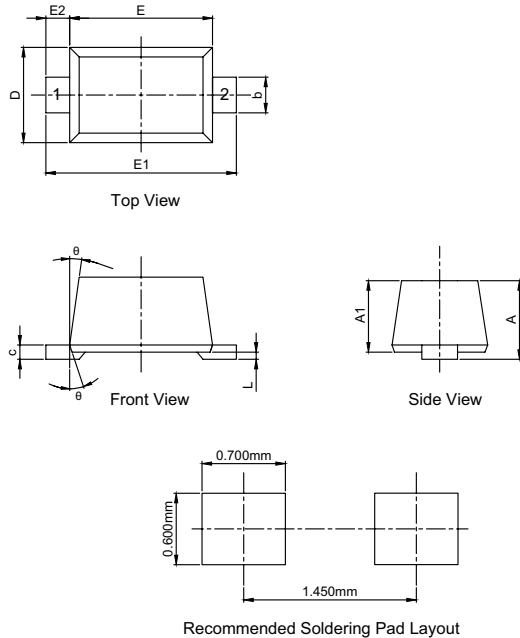
Package Dimensions — SOD523

Symbol	Millimeters		Inches	
	Min	Max	Min	Max
A	0.51	0.77	0.020	0.030
A1	0.50	0.70	0.020	0.028
b	0.25	0.35	0.010	0.014
c	0.08	0.15	0.003	0.006
D	0.70	0.90	0.028	0.035
E	1.10	1.30	0.043	0.051
E1	1.50	1.70	0.059	0.067
E2	0.20 REF		0.001 REF	
L	0.01	0.07	0.000	0.003
θ	7° REF		7° REF	

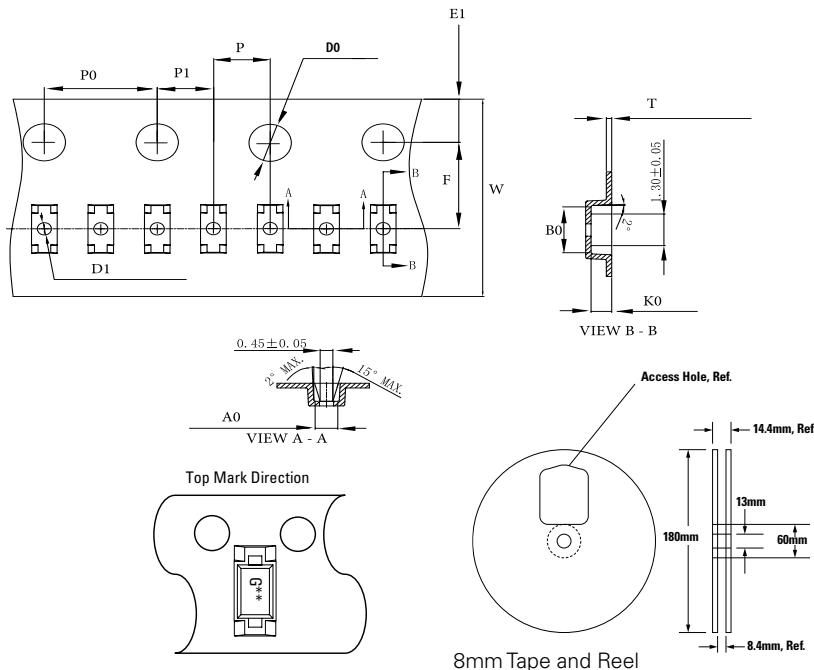
Embossed Carrier Tape & Reel Specification — SOD523

Symbol	Millimeters
A0	0.85min/1.01max
B0	1.91+/-0.08
W	8.0+0.3/-0.10
D0	1.50+0.10
D1	ø1.00min/ø1.25max
E1	1.75+/-0.10
F	3.50+/-0.05
P0	4.00+/-0.10
P	2.00+/-0.05
P1	2.00+/-0.05
K0	0.68min/0.78max
T	0.254+/-0.13

Product Disclaimer: Littelfuse products are not designed for, and shall not be used for, any purpose (including, without limitation, automotive, military, aerospace, medical, life-saving, life-sustaining or nuclear facility applications, devices intended for surgical implant into the body, or any other application in which the failure or lack of desired operation of the product may result in personal injury, death, or property damage) other than those expressly set forth in applicable Littelfuse product documentation. Warranties granted by Littelfuse shall be deemed void for products used for any purpose not expressly set forth in applicable Littelfuse documentation. Littelfuse shall not be liable for any claims or damages arising out of products used in applications not expressly intended by Littelfuse as set forth in applicable Littelfuse documentation. The sale and use of Littelfuse products is subject to Littelfuse Terms and Conditions of Sale, unless otherwise agreed by Littelfuse. "Littelfuse" includes Littelfuse, Inc., and all of its affiliate entities. <http://www.littelfuse.com/disclaimer-electronics>.