

**SP1003 Series - 30pF 30kV Unidirectional Discrete TVS**

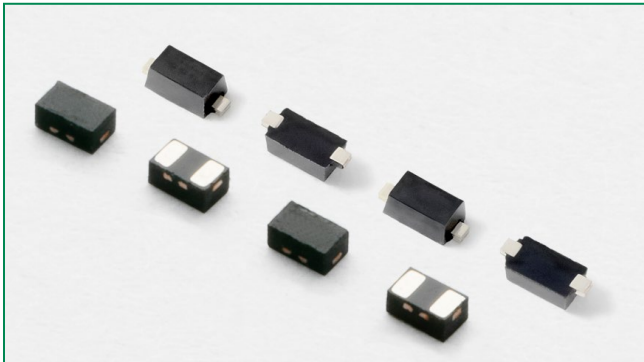

**Pinout**

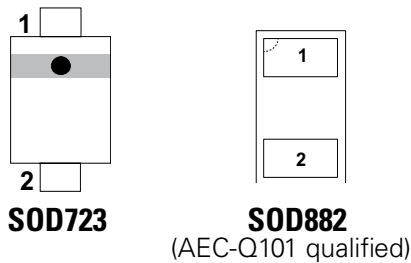

**Functional Block Diagram**



**Description**

The SP1003 diodes are fabricated in a proprietary silicon avalanche technology. These diodes provide a high ESD (electrostatic discharge) protection level for electronic equipment. The SP1003 TVS can safely absorb repetitive ESD strikes at  $\pm 30\text{kV}$  (contact discharge, IEC 61000-4-2) without performance degradation. Additionally, each diode can safely dissipate 7A of 8/20 $\mu\text{s}$  surge current (IEC 61000-4-5) with very low clamping voltages.

**Features**

- ESD, IEC 61000-4-2,  $\pm 30\text{kV}$  contact,  $\pm 30\text{kV}$  air
- EFT, IEC 61000-4-4, 40A (5/50ns)
- Lightning, 7A (8/20 as defined in IEC 61000-4-5 2<sup>nd</sup> edition)
- Low leakage current of 100nA (MAX) at 5V
- Tiny SOD723/ SOD882 (JEDEC MO-236) package saves board space
- Fits solder footprint of industry standard 0402 (1005) components
- AEC-Q101 qualified (SOD882 package)

**Applications**

- Mobile phones components
- Smart phones Digital cameras
- PDAs Portable medical components
- Portable navigation

**Application Example**

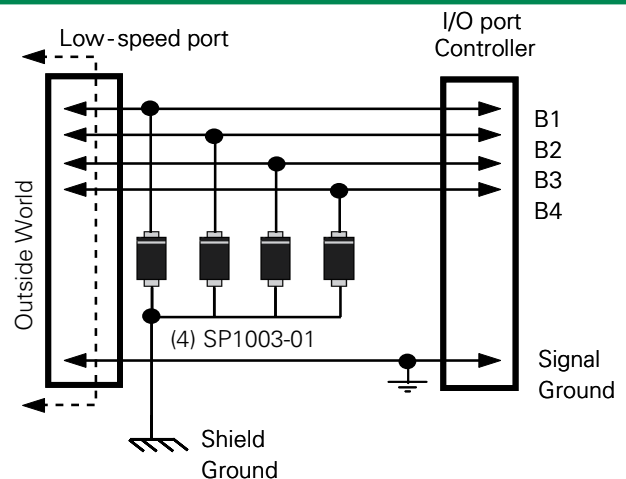

Life Support Note:  
**Not Intended for Use in Life Support or Life Saving Applications**  
The products shown herein are not designed for use in life sustaining or life saving applications unless otherwise expressly indicated.

### Absolute Maximum Ratings

Symbol	Parameter	Value	Units
$I_{PP}$	Peak Pulse Current ( $t_p=8/20\mu s$ )	7.0	A
$T_{OP}$	Operating Temperature	-40 to 125	°C
$T_{STOR}$	Storage Temperature	-55 to 150	°C

*CAUTION: Stresses above those listed in "Absolute Maximum Ratings" may cause permanent damage to the component. This is a stress only rating and operation of the component at these or any other conditions above those indicated in the operational sections of this specification is not implied.*

### Electrical Characteristics ( $T_{OP}=25^\circ C$ )

Parameter	Symbol	Test Conditions	Min	Typ	Max	Units
Forward Voltage Drop	$V_F$	$I_F = 10mA$		0.8	1.2	V
Breakdown Voltage	$V_{BR}$	$I_R = 1mA$	6.0	7.8	8.5	V
Reverse Standoff Voltage	$V_{RWM}$	$I_R = 1\mu A$			5.0	V
Reverse Leakage Current	$I_{LEAK}$	$V_R = 5V$ , I/O to GND			100	nA
Clamp Voltage <sup>1</sup>	$V_C$	$I_{pp} = 6A$ $t_p = 8/20\mu s$		11.4		V
		$I_{pp} = 7A$ $t_p = 8/20\mu s$		12.0		V
Dynamic Resistance <sup>2</sup>	$R_{DYN}$	TLP, $t_p = 100ns$ , I/O to GND		0.25		$\Omega$
ESD Withstand Voltage <sup>1</sup>	$V_{ESD}$	IEC 61000-4-2 (Contact Discharge)		$\pm 30$		kV
		IEC 61000-4-2 (Air Discharge)		$\pm 30$		kV
Diode Capacitance <sup>1</sup>	$C_{I/O-GND}$	Reverse Bias=0V, $f = 1$ MHz		30		pF

Note: 1 - Parameter is guaranteed by design and/or component characterization.

2 - Transmission Line Pulse (TLP) with 100ns width, 2ns rise time, and average window  $t_1=70ns$  to  $t_2=90ns$

### Capacitance vs. Reverse Bias

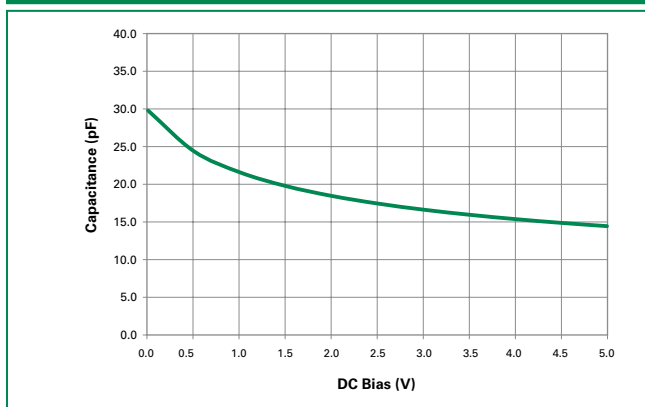

### Clamping Voltage vs. $I_{PP}$

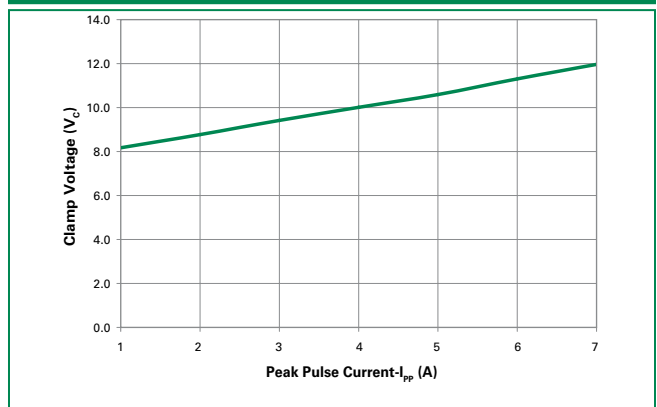

**Transmission Line Pulsing(TLP) Plot**

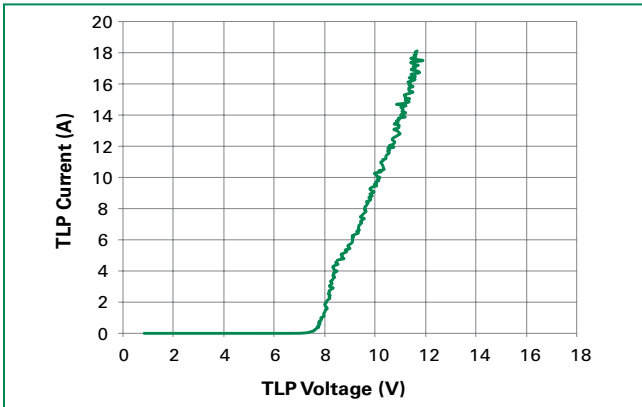

**Leakage vs. Temperature**

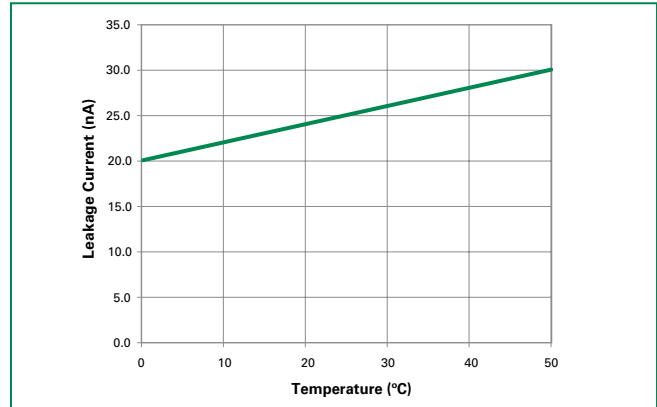

**8/20µs Pulse Waveform**

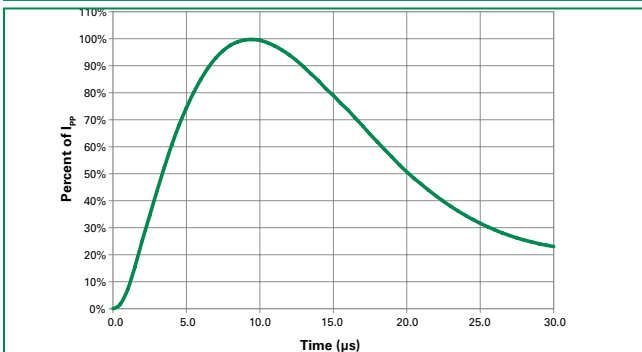

**Soldering Parameters**

Reflow Condition		Pb – Free assembly
Pre Heat	- Temperature Min ( $T_{s(min)}$ )	150°C
	- Temperature Max ( $T_{s(max)}$ )	200°C
	- Time (min to max) ( $t_s$ )	60 – 180 secs
Average ramp up rate (Liquidus) Temp ( $T_L$ ) to peak		3°C/second max
$T_{s(max)}$ to $T_L$ - Ramp-up Rate		3°C/second max
Reflow	- Temperature ( $T_L$ ) (Liquidus)	217°C
	- Temperature ( $t_L$ )	60 – 150 seconds
Peak Temperature ( $T_p$ )		260 <sup>+0/-5</sup> °C
Time within 5°C of actual peak Temperature ( $t_p$ )		20 – 40 seconds
Ramp-down Rate		6°C/second max
Time 25°C to peak Temperature ( $T_p$ )		8 minutes Max.
Do not exceed		260°C

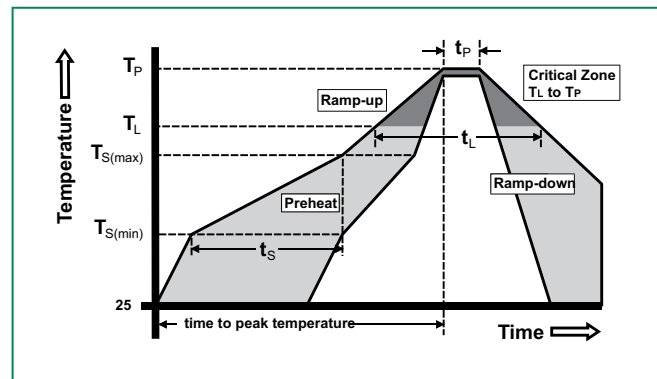

**Part Numbering System**

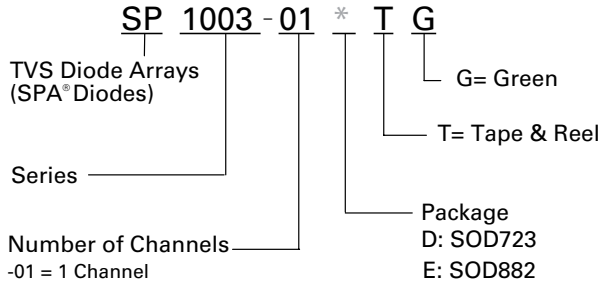

**Product Characteristics**

<b>Lead Plating</b>	Pre-Plated Frame or Matte Tin
<b>Lead Material</b>	Copper Alloy
<b>Lead Coplanarity</b>	0.004 inches(0.102mm)
<b>Substrate material</b>	Silicon
<b>Body Material</b>	Molded Compound
<b>Flammability</b>	UL Recognized compound meeting flammability rating V-0

**Part Marking System**

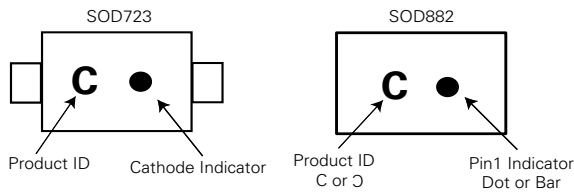

**Ordering Information**

Part Number	Package	Min. Order Qty.
SP1003-01DTG	SOD723	8000
SP1003-01ETG	SOD882	10000

**Package Dimensions — SOD723**

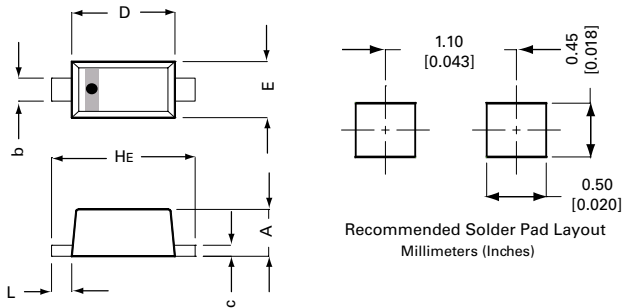

Symbol	SOD723			
	Millimeters		Inches	
	Min	Max	Min	Max
<b>A</b>	0.46	0.65	0.018	0.026
<b>b</b>	0.23	0.35	0.009	0.014
<b>c</b>	0.08	0.15	0.003	0.006
<b>D</b>	0.90	1.10	0.035	0.043
<b>E</b>	0.55	0.65	0.022	0.026
<b>HE</b>	1.30	1.50	0.051	0.059
<b>L</b>	0.15	0.25	0.006	0.010

**Package Dimensions — SOD882**

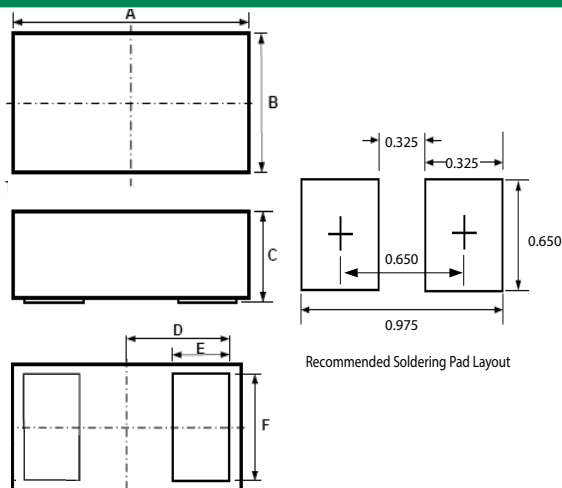

Symbol	Package	SOD882				
	JEDEC	MO-236				
	Millimeters			Inches		
	Min	Typ	Max	Min	Typ	Max
<b>A</b>	0.90	1.00	1.10	0.035	0.039	0.043
<b>B</b>	0.50	0.60	0.70	0.020	0.024	0.028
<b>C</b>	0.40	0.50	0.60	0.016	0.020	0.024
<b>D</b>	0.45			0.018		
<b>E</b>	0.20	0.25	0.35	0.008	0.010	0.014
<b>F</b>	0.45	0.50	0.55	0.018	0.020	0.022

**Embossed Carrier Tape & Reel Specification – SOD723**

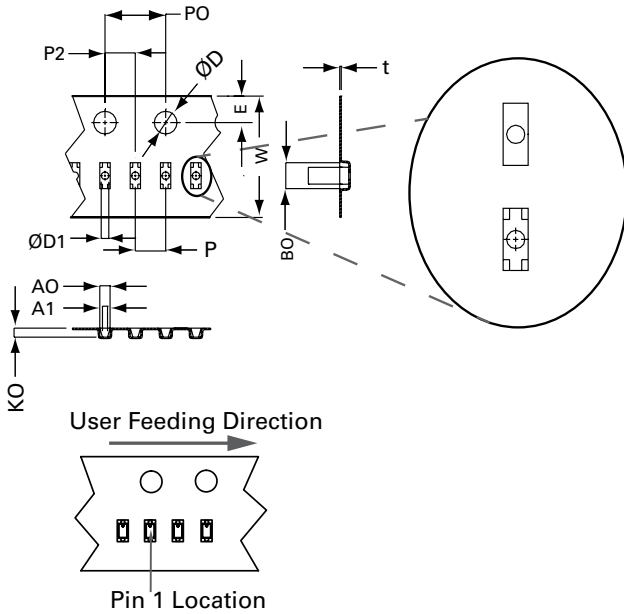

Symbol	Millimetres		Inches	
	Min	Max	Min	Max
E	1.65	1.85	0.064	0.072
F	3.40	3.60	0.134	0.142
D1	0.45	0.55	0.017	0.021
D	1.50	-	0.060	-
PO	3.90	4.10	0.153	0.161
10PO	40.0 ± 0.20		1.570 ± 0.010	
W	7.90	8.20	0.311	0.322
P2/P	1.90	2.10	0.074	0.082
AO	0.65	0.81	0.026	0.032
A1	0.33 REF		0.010 REF	
BO	1.51	1.76	0.059	0.069
B1	1.10 REF		0.040 REF	
KO	0.54	0.78	0.021	0.031
t	-	0.21	-	0.008

**Embossed Carrier Tape & Reel Specification – SOD882**

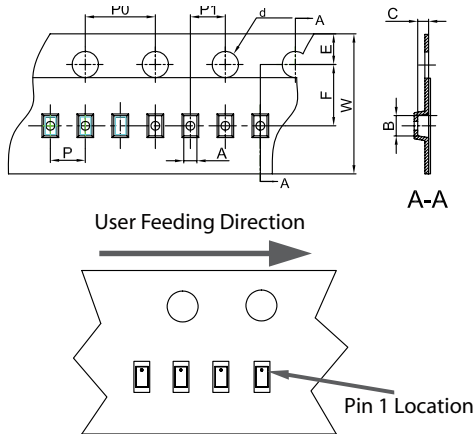

Symbol	Millimetres		Inches	
	Min	Max	Min	Max
A	0.65	0.70	0.026	0.028
B	1.10	1.20	0.043	0.047
C	0.50	0.60	0.020	0.024
dØ	1.40	1.60	0.055	0.063
E	1.65	1.85	0.065	0.073
F	3.40	3.60	0.134	0.142
P0	3.90	4.10	0.154	0.161
P	1.90	2.10	0.075	0.083
P1	1.90	2.10	0.075	0.083
W	7.90	8.10	0.311	0.319

