

# SP1004 Series

## 5pF 8kV Bidirectional TVS Array

**OBSOLETE** DATE: 6/25/2021 PCN/ECN# ESU270-54  
REPLACED BY: \_\_\_\_\_ N/A

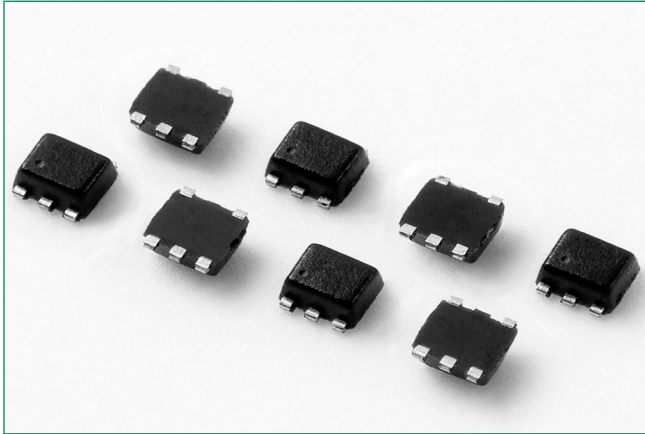

### Additional Information



Resources



Accessories



Samples

### Pinout

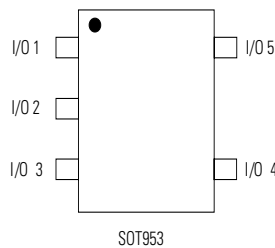

#### Notes:

<sup>1</sup>Any of the 5 I/O pins can be tied to GND to provide 4 channels of bidirectional protection

### Functional Block Diagram

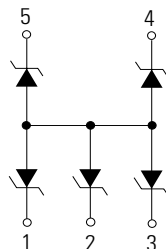

### Description

The SP1004 are back-to-back zener diodes fabricated in a proprietary silicon avalanche technology protect each I/O pin to provide a high level of protection for electronic equipment that may experience destructive electrostatic discharges (ESD). These robust diodes can safely absorb repetitive ESD strikes at the maximum level specified in the IEC 61000-4-2 international standard (Level 4,  $\pm 8\text{kV}$  contact discharge) without performance degradation. Their very low loading capacitance also makes them ideal for protecting high-speed signal pins.

### Features & Benefits

- RoHS compliant and Lead-free
- ESD, IEC 61000-4-2,  $\pm 8\text{kV}$  contact,  $\pm 15\text{kV}$  air
- Capable of withstanding  $>1,000$   $\pm 8\text{kV}$  ESD strikes
- Lightning, IEC 61000-4-5, 2nd Edition, 2A ( $t_p=8/20\mu\text{s}$ )
- Low capacitance of 5pF (TYP) per I/O
- Low leakage current of  $1\mu\text{A}$  (MAX) at 5V
- Small SOT953 package
- AEC-Q101 Qualified

### Applications

- MP3-PMPs
- DVD players
- Desktops
- Mobile phones
- Digital cameras
- Set top boxes
- Notebooks

### Application Example

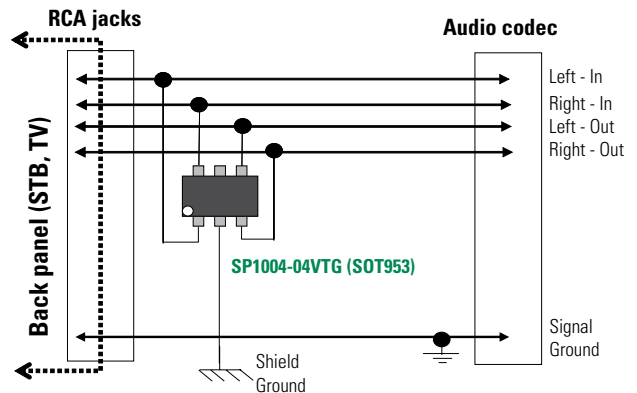

Life Support Note:

#### Not Intended for Use in Life Support or Life Saving Applications

The products shown herein are not designed for use in life sustaining or life saving applications unless otherwise expressly indicated.

# SP1004 Series

## 5pF 8kV Bidirectional TVS Array

### Absolute Maximum Ratings

Symbol	Parameter	Value	Units
$I_{PP}$	Peak Pulse Current ( $t_p=8/20\mu s$ )	2.0	A
$T_{OP}$	Operating Temperature	-40 to 125	°C
$T_{STOR}$	Storage Temperature	-55 to 150	°C

**Caution:** Stresses above those listed in "Absolute Maximum Ratings" may cause permanent damage to the device. This is a stress only rating and operation of the device at these or any other conditions above those indicated in the operational sections of this specification is not implied.

### Thermal Information

Parameter	Rating	Units
Storage Temperature Range	-55 to 150	°C
Maximum Junction Temperature	150	°C
Maximum Lead Temperature (Soldering 20-40s)	260	°C

### Electrical Characteristics (TOP=25°C)

Parameter	Symbol	Test Conditions	Min	Typ	Max	Units
Reverse Voltage Drop <sup>1</sup>	$V_R$	$I_R=1mA$	6.0		9.5	V
Reverse Standoff Voltage <sup>1</sup>	$V_{RWM}$	$I_R \leq 1\mu A$			6.0	V
Reverse Leakage Current <sup>1</sup>	$I_{LEAK}$	$V_R=5V$			0.1	$\mu A$
Clamp Voltage <sup>2</sup>	$V_C$	$I_{PP}=1A, t_p=8/20\mu s$		10		V
		$I_{PP}=2A, t_p=8/20\mu s$		12		V
Dynamic Resistance	$R_{DYN}$	$(V_{C2} - V_{C1}) / (I_{PP2} - I_{PP1})$		2.0		$\Omega$
ESD Withstand Voltage <sup>1,2</sup>	$V_{ESD}$	IEC 61000-4-2 (Contact Discharge) <sup>3</sup>	$\pm 8$			kV
		IEC 61000-4-2 (Air Discharge)	$\pm 15$			kV
Diode Capacitance <sup>1,2</sup>	$C_D$	Reverse Bias=0V		6	7	pF
		Reverse Bias=1.5V		5	6	pF

**Note:** <sup>1</sup> Parameter specified with pin 2 grounded externally.

<sup>2</sup> Parameter is guaranteed by design and/or device characterization.

<sup>3</sup> Capable of withstanding >1,000 pulses at 1s intervals.

### Capacitance vs. Reverse Bias

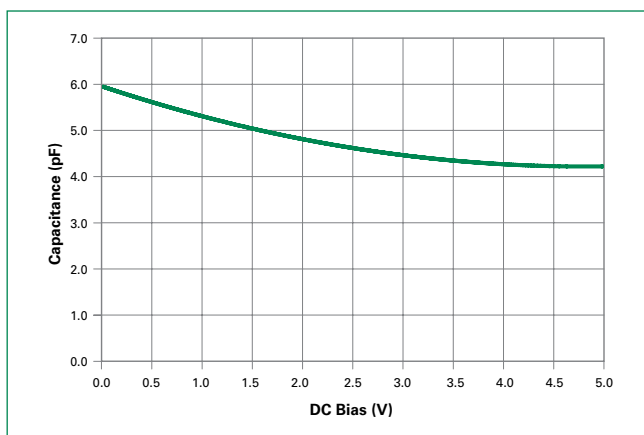

### Insertion Loss (S21)

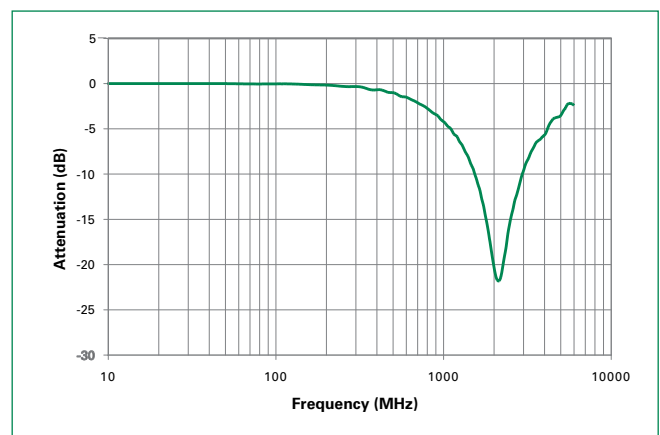

# SP1004 Series

## 5pF 8kV Bidirectional TVS Array

### Soldering Parameters

<b>Reflow Condition</b>	Pb – Free assembly	
<b>Pre Heat</b>	- Temperature Min ( $T_{s(min)}$ )	150°C
	- Temperature Max ( $T_{s(max)}$ )	200°C
	- Time (min to max) ( $t_s$ )	60 – 180 secs
<b>Average ramp up rate (Liquidus) Temp (<math>T_L</math>) to peak</b>	3°C/second max	
<b><math>T_{s(max)}</math> to <math>T_L</math> - Ramp-up Rate</b>	3°C/second max	
<b>Reflow</b>	- Temperature ( $T_L$ ) (Liquidus)	217°C
	- Temperature ( $t_L$ )	60 – 150 seconds
<b>Peak Temperature (<math>T_p</math>)</b>	260 <sup>+0/-5</sup> °C	
<b>Time within 5°C of actual peak Temperature (<math>t_p</math>)</b>	20 – 40 seconds	
<b>Ramp-down Rate</b>	6°C/second max	
<b>Time 25°C to peak Temperature (<math>T_p</math>)</b>	8 minutes Max.	
<b>Do not exceed</b>	260°C	

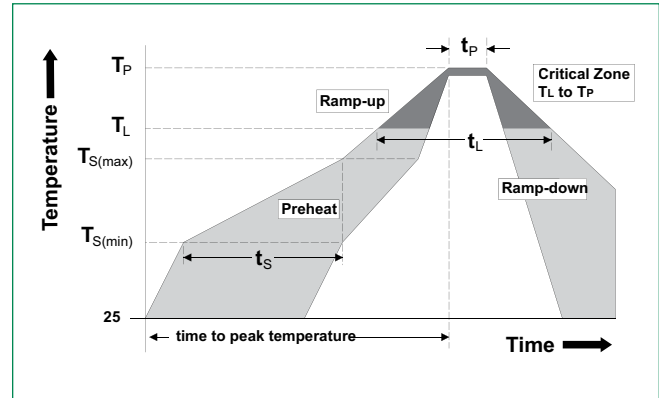

### Package Dimensions – SOT953

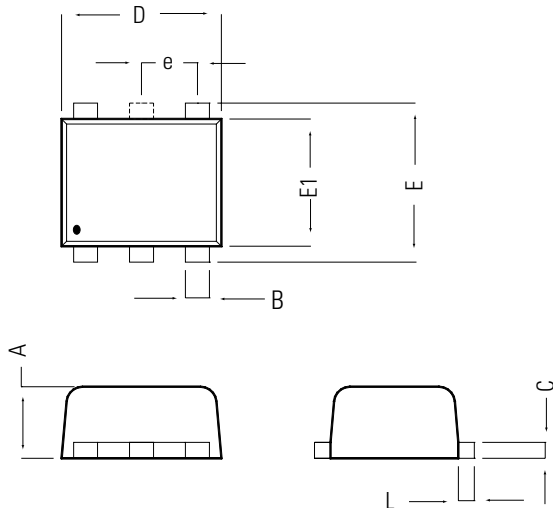

Symbol	SOT953			
	Millimeters		Inches	
	Min	Max	Min	Max
<b>A</b>	0.44	0.5	0.170	0.020
<b>B</b>	0.10	0.20	0.004	0.008
<b>c</b>	0.05	0.15	0.002	0.006
<b>D</b>	0.95	1.05	0.037	0.041
<b>E</b>	0.95	1.05	0.037	0.041
<b>E1</b>	0.75	0.85	0.029	0.033
<b>e</b>	0.35 BSC		0.014 BSC	
<b>L</b>	0.05	0.15	0.002	0.006

# SP1004 Series

## 5pF 8kV Bidirectional TVS Array

### Part Numbering System

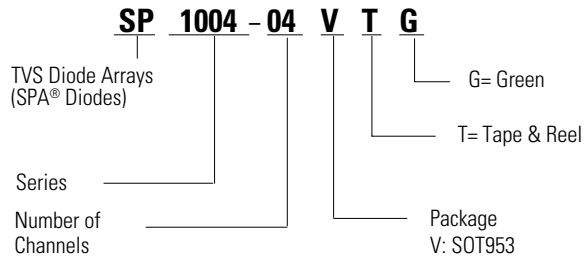

### Part Marking System

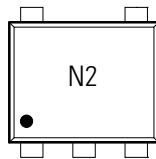

### Product Characteristics

<b>Lead Plating</b>	Pre-Plated Frame
<b>Lead Material</b>	Copper Alloy
<b>Lead Coplanarity</b>	0.0004 inches (0.102mm)
<b>Substitute Material</b>	Silicon
<b>Body Material</b>	Molded Epoxy
<b>Flammability</b>	UL 94 V-0

#### Notes :

1. All dimensions are in millimeters
2. Dimensions include solder plating.
3. Dimensions are exclusive of mold flash & metal burr.
4. Blo is facing up for mold and facing down for trim/form, i.e. reverse trim/form.
5. Package surface matte finish VDI 11-13.

### Ordering Information

Part Number	Package	Marking	Min. Order Qty.
SP1004-04VTG	SOT953	N2	8000

### Embossed Carrier Tape & Reel Specification – SOT953

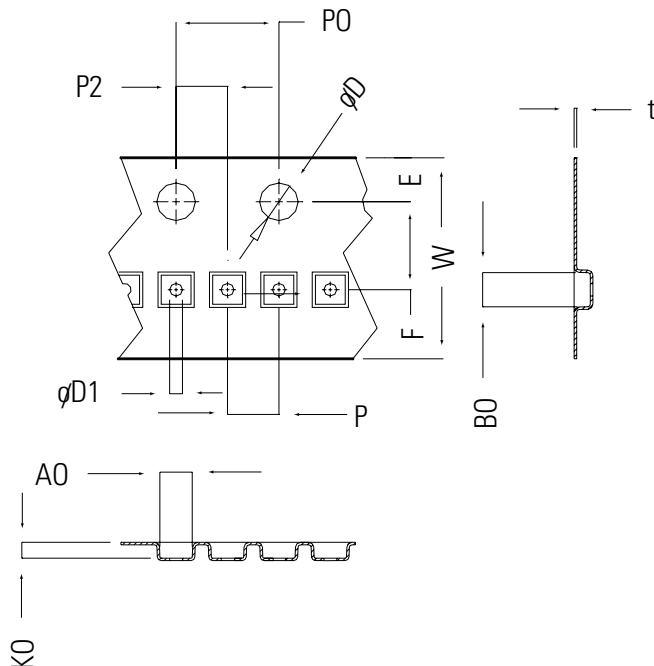

Symbol	Millimetres		Inches	
	Min	Max	Min	Max
<b>E</b>	1.65	1.85	0.065	0.073
<b>F</b>	3.45	3.55	0.136	0.140
<b>D1</b>	0.45	0.55	0.018	0.022
<b>D</b>	1.50 min		0.059 min	
<b>P0</b>	3.90	4.10	0.154	0.161
<b>10P0</b>	40.0 ± 0.20		1.575 ± 0.008	
<b>P</b>	1.95	2.05	0.077	0.081
<b>P2</b>	1.95	2.05	0.077	0.081
<b>W</b>	7.90	8.20	0.311	0.323
<b>A0</b>	1.11	1.21	0.044	0.048
<b>B0</b>	1.11	1.21	0.044	0.048
<b>K0</b>	0.58	0.68	0.023	0.027
<b>t</b>	0.22 max		0.009 max	

**Disclaimer Notice** - Information furnished is believed to be accurate and reliable. However, users should independently evaluate the suitability of and test each product selected for their own applications. Littelfuse products are not designed for, and may not be used in, all applications. Read complete Disclaimer Notice at [www.littelfuse.com/disclaimer-electronics](http://www.littelfuse.com/disclaimer-electronics).