

SP1006 Series

25pF 30kV Unidirectional Discrete TVS

**Additional Information**

Resources



Accessories

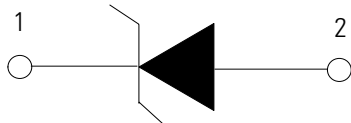

Samples

Pinout**Functional Block Diagram****Description**

Zener diodes fabricated in a proprietary silicon avalanche technology protect each I/O pin to provide a high level of protection for electronic equipment that may experience destructive electrostatic discharges (ESD). These robust diodes can safely absorb repetitive ESD strikes at $\pm 30\text{kV}$ (contact discharge, IEC 61000-4-2) without performance degradation. Additionally, each diode can safely dissipate 5A of 8/20 μs surge current (IEC 61000-4-5, 2nd Edition) with very low clamping voltages.

Features & Benefits

- RoHS compliant and Lead-free
- ESD, IEC 61000-4-2, $\pm 30\text{kV}$ contact, $\pm 30\text{kV}$ air
- EFT, IEC 61000-4-4, 40A (5/50ns)
- Lightning, 5A (8/20 μs as defined in IEC 61000-4-5, 2nd Edition)
- Low leakage current of 0.5 μA (MAX) at 5V
- Space efficient 0201 footprint
- AEC-Q101 qualified

Applications

- Mobile phones
- Smart phones
- PDAs
- Digital cameras
- Portable navigation devices
- Portable medical devices

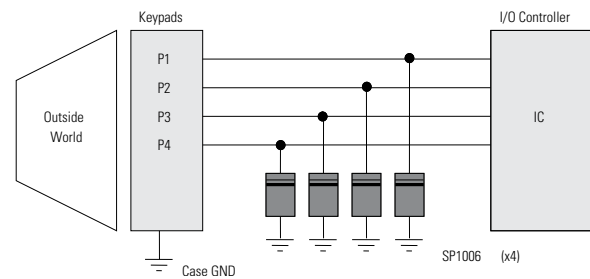
Application Example

Life Support Note:

Not Intended for Use in Life Support or Life Saving Applications

The products shown herein are not designed for use in life sustaining or life saving applications unless otherwise expressly indicated.

SP1006 Series

25pF 30kV Unidirectional Discrete TVS

Absolute Maximum Ratings

Symbol	Parameter	Value	Units
I_{PP}	Peak Pulse Current ($t_p=8/20\mu s$)	5	A
T_{OP}	Operating Temperature	-40 to 125	°C
T_{STOR}	Storage Temperature	-55 to 150	°C

Caution: Stresses above those listed in "Absolute Maximum Ratings" may cause permanent damage to the device. This is a stress only rating and operation of the device at these or any other conditions above those indicated in the operational sections of this specification is not implied.

Electrical Characteristics ($T_{OP}=25^\circ C$)

Parameter	Symbol	Test Conditions	Min	Typ	Max	Units
Reverse Standoff Voltage	V_{RWM}				6.0	V
Breakdown Voltage	V_{BR}	$I_R=1mA$ (Pin 1 to 2)		7.8		V
Forward Voltage Drop	V_F	$I_R=1mA$ (Pin 2 to 1)		0.8		V
Leakage Current	I_{LEAK}	$V_R=5V$		0.1	0.5	μA
Clamp Voltage ¹	V_C	$I_{PP}=1A, t_p=8/20\mu s$ (Pin 1 to 2)		8.3		V
		$I_{PP}=2A, t_p=8/20\mu s$ (Pin 1 to 2)		9.2		V
Dynamic Resistance	R_{DYN}	$(V_{C2} - V_{C1}) / (I_{PP2} - I_{PP1})$		0.9		Ω
ESD Withstand Voltage ¹	V_{ESD}	IEC 61000-4-2 (Contact Discharge)	± 30			kV
		IEC 61000-4-2 (Air Discharge)	± 30			kV
Diode Capacitance ¹	C_D	Reverse Bias=0V		25		pF
		Reverse Bias=2.5V		15		pF

Note: ¹ Parameter is guaranteed by design and/or device characterization.

Capacitance vs. Reverse Bias

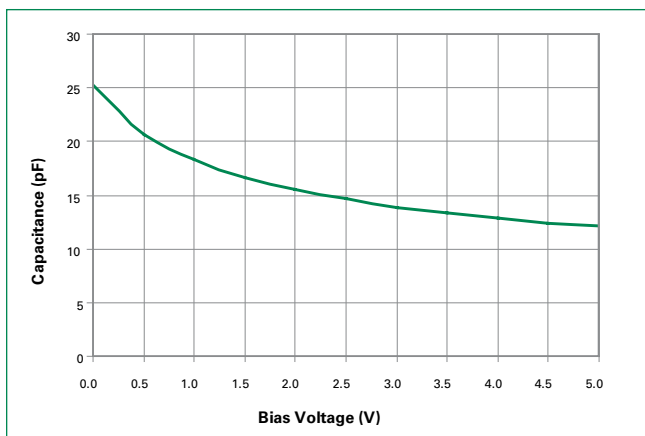

Pulse Waveform

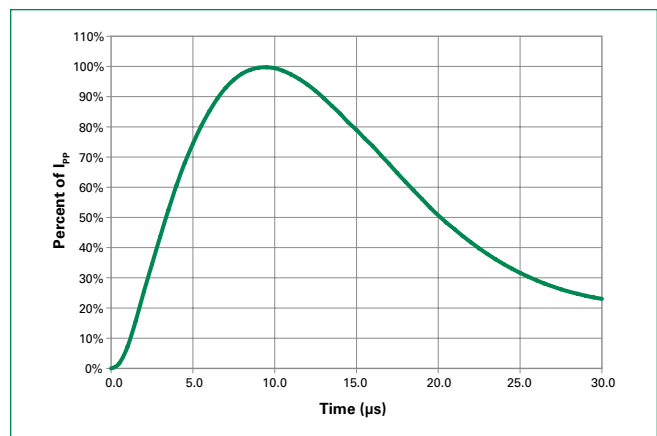

SP1006 Series

25pF 30kV Unidirectional Discrete TVS

Clamping Voltage vs. I_{PP}

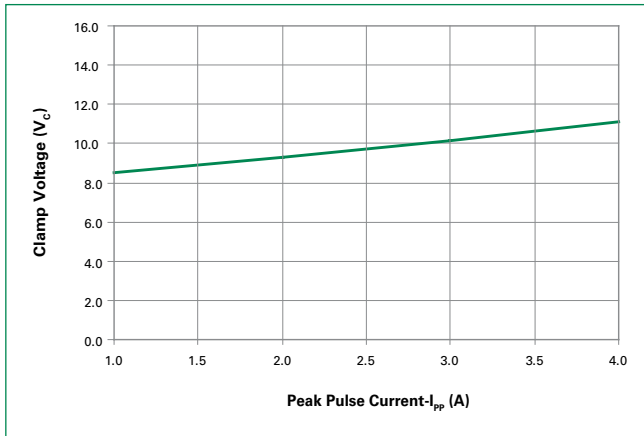

Transmission Line Pulsing (TLP) Plot

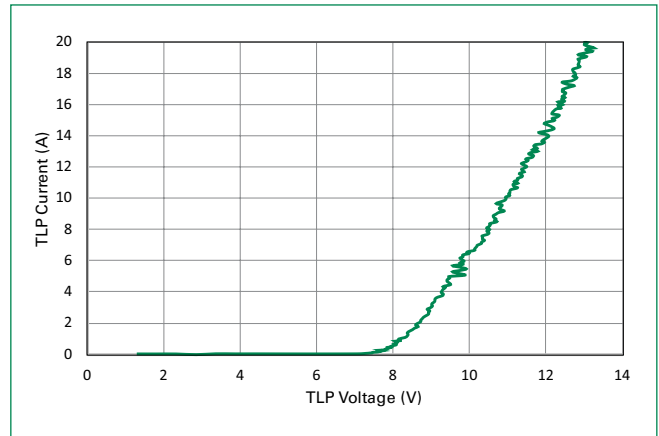

Soldering Parameters

Reflow Condition		Pb – Free assembly
Pre Heat	- Temperature Min ($T_{s(min)}$)	150°C
	- Temperature Max ($T_{s(max)}$)	200°C
	- Time (min to max) (t_s)	60 – 120 secs
Average ramp up rate (Liquidus) Temp (T_L) to peak		3°C/second max
$T_{S(max)}$ to T_L - Ramp-up Rate		3°C/second max
Reflow	- Temperature (T_L) (Liquidus)	217°C
	- Temperature (t_L)	60 – 150 seconds
Peak Temperature (T_p)		260 ^{+0/-5} °C
Time within 5°C of actual peak Temperature (t_p)		30 seconds
Ramp-down Rate		6°C/second max
Time 25°C to peak Temperature (T_p)		8 minutes Max.

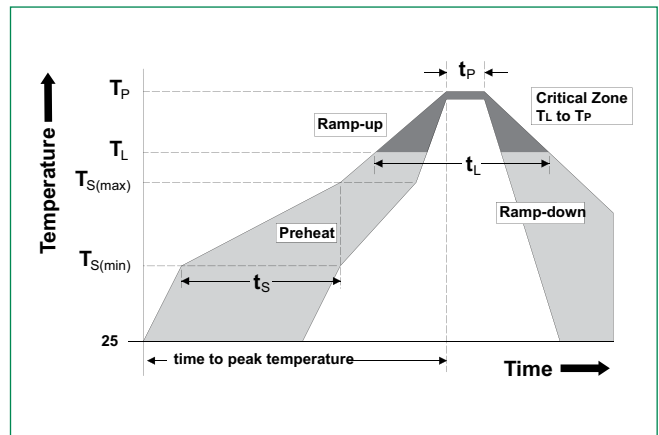

Package Dimensions – μ DFN-2 (0201)

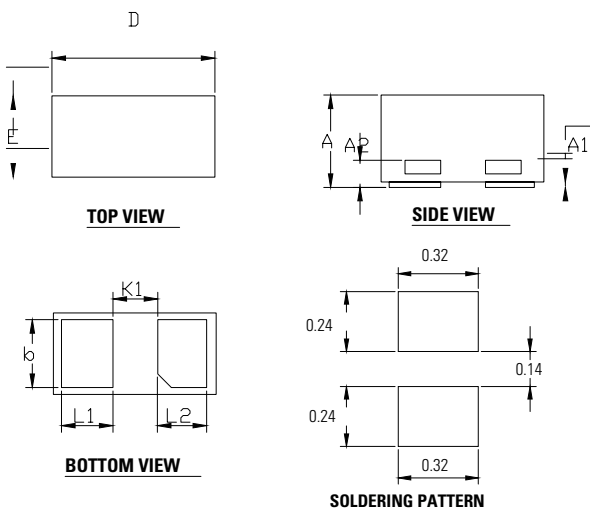

Package	μ DFN-2 (0201)			
	JEDEC MO-236			
	Millimeters		Inches	
Symbol	Min	Max	Min	Max
A	0.23	0.33	0.009	0.013
A1	0.00	0.05	0.000	0.002
A2	0.10 REF		0.004 REF	
b	0.18	0.30	0.007	0.012
D	0.55	0.65	0.022	0.026
E	0.25	0.35	0.010	0.014
L1	0.12	0.24	0.005	0.009
L2	0.12	0.23	0.005	0.009
K1	0.165 REF		0.006 REF	

SP1006 Series

25pF 30kV Unidirectional Discrete TVS

Part Numbering System

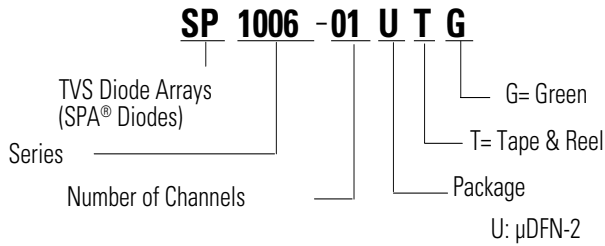

Product Characteristics

Lead Plating	Pre-Plated Frame
Lead Material	Copper Alloy
Lead Coplanarity	0.0004 inches (0.102mm)
Substrate Material	Silicon
Body Material	Molded Epoxy
Flammability	UL Recognized epoxy meeting flammability rating V-0

Part Marking System



Ordering Information

Part Number	Package	Min. Order Qty.
SP1006-01UTG	μDFN-2	15000

Embossed Carrier Tape & Reel Specification – μDFN-2

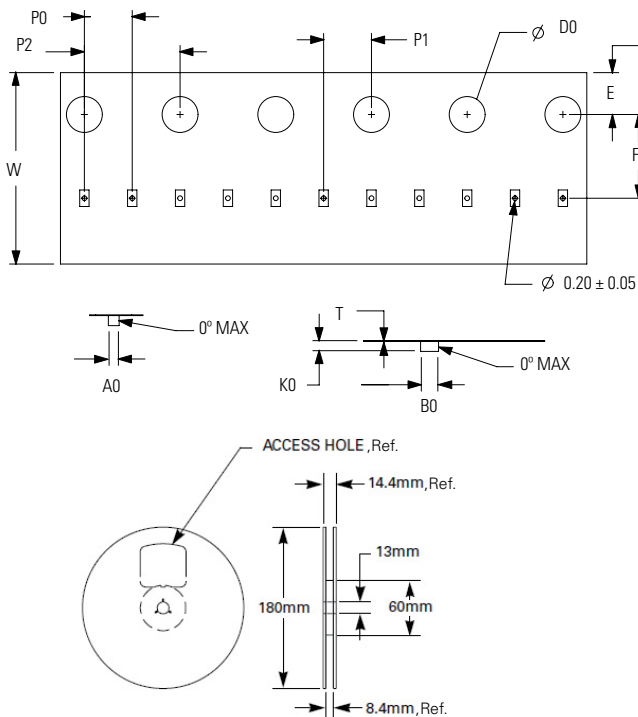

8mm TAPE AND REEL

Symbol	Millimetres		Inches	
	Min	Max	Min	Max
A0	0.33	0.40	0.013	0.016
B0	0.63	0.70	0.025	0.028
D0	1.40	1.60	0.055	0.063
E	1.65	1.85	0.065	0.073
F	3.45	3.55	0.136	0.140
K0	0.30	0.39	0.012	0.015
P0	1.90	2.10	0.075	0.083
P1	1.95	2.05	0.077	0.081
P2	3.90	4.10	0.154	0.161
T	0.13	0.25	0.005	0.010
W	7.90	8.30	0.311	0.327

Disclaimer Notice - Information furnished is believed to be accurate and reliable. However, users should independently evaluate the suitability of and test each product selected for their own applications. Littelfuse products are not designed for, and may not be used in, all applications. Read complete Disclaimer Notice at <http://www.littelfuse.com/disclaimer-electronics>.