

# SP1255 Series

## 160A for V<sub>BUS</sub>

**OBSOLETE** DATE: 6/25/2021 PCN/ECN# ESU270-54  
 REPLACED BY: N/A

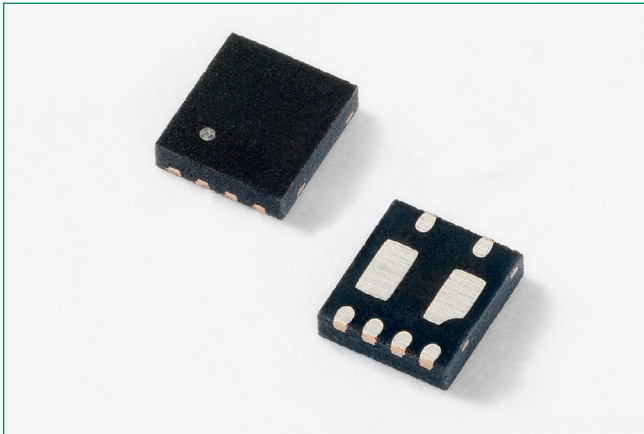

### Description

The SP1255 integrates a 13.5V TVS diode to provide lightning surge protection for the USB VBUS pin up to 160A ( $t_P=8/20\mu s$ ) per the IEC 61000-4-5 standard. The SP1255 provides superior protection for current intensive applications such as fast charging peripherals.

The SP1255 comes in a space saving 2.0x1.8mm  $\mu$ DFN package with a typical height of 0.55mm making it an ideal solution for smart phones, tablets, and other portable electronics.

### Features & Benefits

- ESD, IEC 61000-4-2,  $\pm 30kV$  contact,  $\pm 30kV$  air
- EFT, IEC 61000-4-4, 80A ( $t_P=5/50ns$ )
- Surge, IEC 61000-4-5 2nd edition, 160A ( $t_P=8/20\mu s$ )
- Protection for VBUS operating up to 13.5V
- Benchmark setting protection
- High current handling capability for fast charging applications
- Halogen free, Lead free and RoHS compliant
- AEC-Q101 qualified

### Additional Information



Resources



Accessories



Samples

### Applications

- Protection for the VBUS circuit on USB2.0 Fast Charging

### Functional Block Diagram

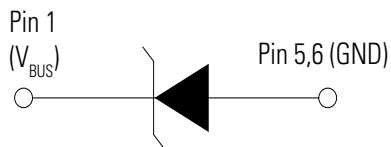

### Pinout

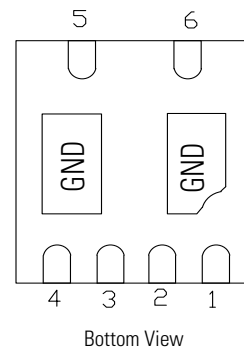

Life Support Note:

**Not Intended for Use in Life Support or Life Saving Applications**

The products shown herein are not designed for use in life sustaining or life saving applications unless otherwise expressly indicated.

# SP1255 Series

## 160A for V<sub>BUS</sub>

### Absolute Maximum Ratings

Symbol	Parameter	Value	Units
I <sub>PP</sub> (Pin 1)	Peak Current (t <sub>p</sub> =8/20μs)	160	A
T <sub>OP</sub>	Operating Temperature	-40 to 125	°C
T <sub>STOR</sub>	Storage Temperature	-55 to 150	°C

**CAUTION:** Stresses at or above those listed in "Absolute Maximum Ratings" may cause permanent damage to the device. This is a stress only rating and operation of the device at these or any other conditions above those indicated in the operational sections of this specification is not implied. Also due to variations in test equipment stresses shown above are averages.

### Electrical Characteristics (TOP=25°C)

Parameter	Symbol	Test Conditions	Min	Typ	Max	Units
USB V <sub>BUS</sub> (Pin 1)						
Reverse Standoff Voltage	V <sub>RWM</sub>	Pin 1 to GND			13.5	V
Reverse Breakdown Voltage	V <sub>BR</sub>	I <sub>T</sub> =1mA, Pin 1 to GND		14.5	16.5	V
Reverse Leakage Current	I <sub>LEAK</sub>	V <sub>R</sub> =13.5V, Pin 1 to GND		0.05	1	μA
Forward Voltage	V <sub>F</sub>	I <sub>F</sub> =10mA, GND to Pin 1	0.6	0.7	1.0	V
Clamp Voltage <sup>1</sup>	V <sub>C</sub>	I <sub>PP</sub> =30A, t <sub>p</sub> =8/20μs, Fwd		16.5	18	V
		I <sub>PP</sub> =100A, t <sub>p</sub> =8/20μs, Fwd		19.5	25	V
		I <sub>PP</sub> =135A, t <sub>p</sub> =8/20μs, Fwd		25.5		V
		I <sub>PP</sub> =160A, t <sub>p</sub> =8/20μs, Fwd		28.0		V
ESD Withstand Voltage <sup>1</sup>	V <sub>ESD</sub>	IEC 61000-4-2 (Contact)	±30			kV
		IEC 61000-4-2 (Air)	±30			kV
Diode Capacitance <sup>1</sup>	C <sub>D</sub>	Reverse Bias=0V, f=1MHz		1300	2500	pF

**Note:** 1 Parameter is guaranteed by design and/or device characterization.

### Capacitance vs. Reverse Bias (Pin1 to GND)

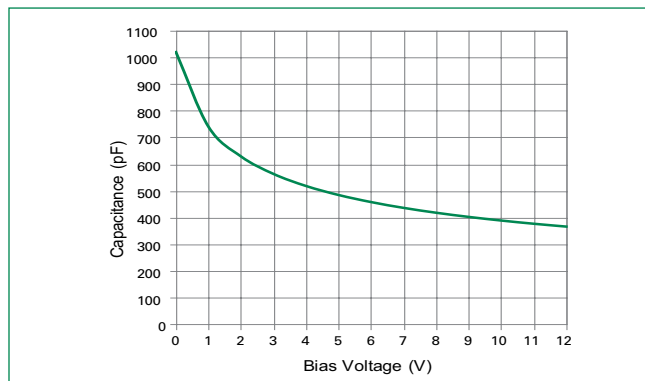

### Clamping Voltage vs. Peak Pulse Current (Pin1 to GND)

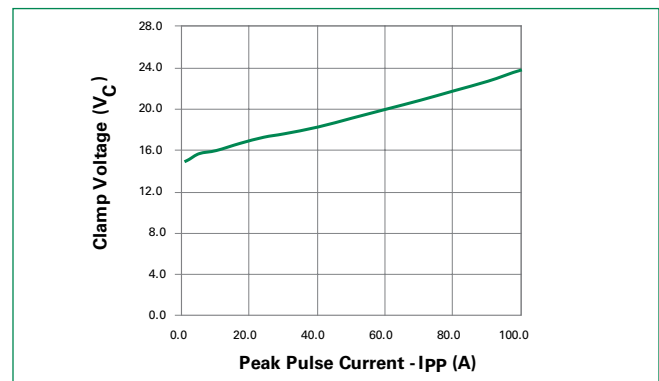

### Non-Repetitive Peak Pulse Power vs. Pulse Duration (Pin1 to GND)

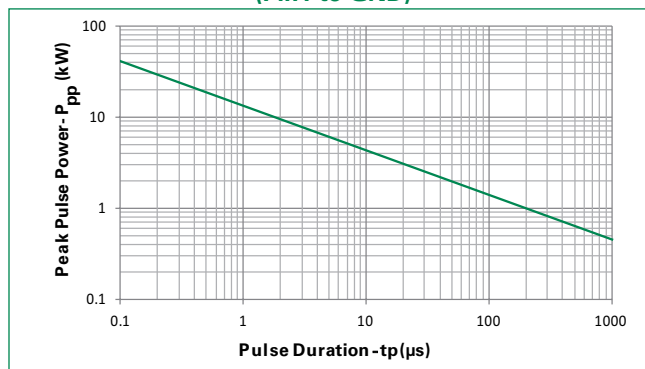

# SP1255 Series

## 160A for $V_{BUS}$

### Soldering Parameters

<b>Reflow Condition</b>		Pb – Free assembly
<b>Pre Heat</b>	- Temperature Min ( $T_{s(min)}$ )	150°C
	- Temperature Max ( $T_{s(max)}$ )	200°C
	- Time (min to max) ( $t_p$ )	60 – 180 secs
<b>Average ramp up rate (Liquidus) Temp (<math>T_L</math>) to peak</b>		3°C/second max
<b><math>T_{S(max)}</math> to <math>T_L</math> - Ramp-up Rate</b>		3°C/second max
<b>Reflow</b>	- Temperature ( $T_L$ ) (Liquidus)	217°C
	- Temperature ( $t_L$ )	60 – 150 seconds
<b>Peak Temperature (<math>T_p</math>)</b>		260 <sup>+0/-5</sup> °C
<b>Time within 5°C of actual peak Temperature (<math>t_p</math>)</b>		20 – 40 seconds
<b>Ramp-down Rate</b>		6°C/second max
<b>Time 25°C to peak Temperature (<math>T_p</math>)</b>		8 minutes Max.
<b>Do not exceed</b>		260°C

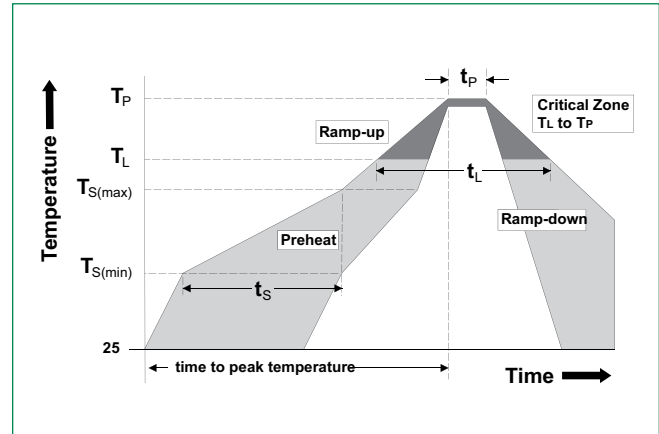

### Part Numbering System

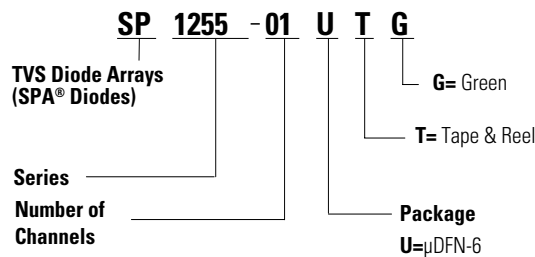

### Product Characteristics

<b>Lead Plating</b>	Pre-Plated Frame
<b>Lead Material</b>	Copper Alloy
<b>Lead Coplanarity</b>	0.004 inches(0.102mm)
<b>Substrate material</b>	Silicon
<b>Body Material</b>	Molded Epoxy
<b>Flammability</b>	UL 94 V-0

#### Notes :

1. All dimensions are in millimeters
2. Dimensions include solder plating.
3. Dimensions are exclusive of mold flash & metal burr.
4. Blo is facing up for mold and facing down for trim/form, i.e. reverse trim/form.
5. Package surface matte finish VDI 11-13.

### Part Marking System

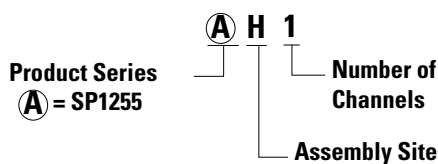

### Ordering Information

Part Number	Package	Marking	Min. Order Qty.	Packaging Option	P0/P1	Packaging Specification
SP1255-01UTG	μDFN-6	ⒶH1	3000	Tape & Reel – 8mm tape/7" reel	4mm/4mm	EIA RS-481

# SP1255 Series

160A for  $V_{BUS}$

## Package Dimensions — $\mu$ DFN-6 (1.8x2.0x0.55mm)

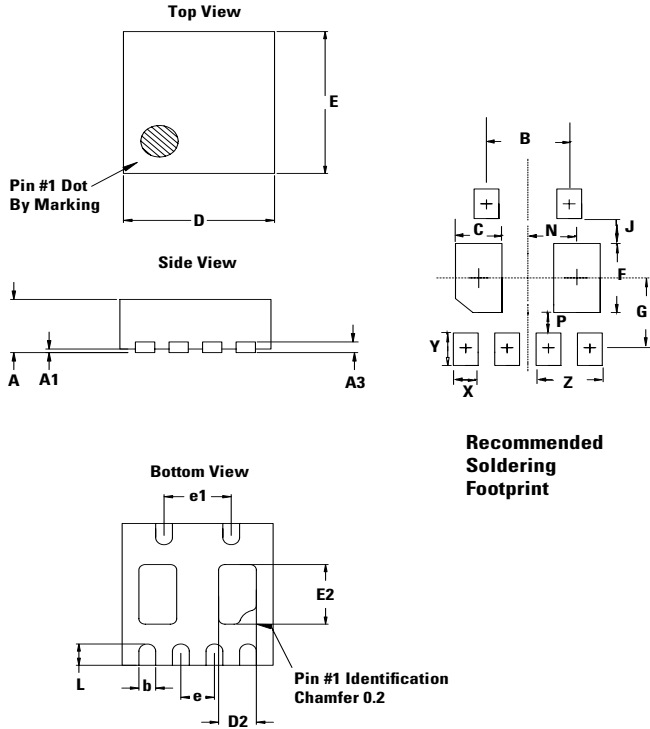

$\mu$ DFN6 (1.8x2.0x0.55mm)						
JEDEC MO-229						
Symbol	Millimeters			Inches		
	Min	Nom	Max	Min	Nom	Max
A	0.50	0.55	0.60	0.020	0.022	0.024
A1	0.00	-	0.05	0.000	-	0.002
A3	0.15 Ref			0.006 Ref		
D	1.75	1.80	1.85	0.069	0.071	0.073
E	1.95	2.00	2.05	0.077	0.079	0.081
b	0.15	0.20	0.25	0.006	0.008	0.010
L	0.20	0.30	0.40	0.008	0.012	0.016
D2	0.35	0.45	0.55	0.014	0.018	0.022
E2	0.74	0.84	0.94	0.029	0.033	0.037
e	0.40 BSC			0.016 BSC		
e1	0.80 BSC			0.031 BSC		
B	0.80 BSC			0.031 BSC		
C	0.35	0.45	0.55	0.014	0.018	0.022
F	0.81	0.84	0.87	0.032	0.033	0.034
G	0.82	0.85	0.88	0.032	0.033	0.034
J	0.24	0.25	0.26	0.010	0.010	0.010
N	0.47	0.48	0.49	0.018	0.019	0.020
P	0.24	0.25	0.26	0.010	0.010	0.010
X	0.23	0.24	0.25	0.009	0.009	0.009
Y	0.35	0.36	0.37	0.014	0.014	0.014
Z	0.62	0.64	0.66	0.024	0.025	0.026

**Notes:**

1. Dimension and tolerancing conform to ASME Y14.5M-1994.
2. Controlling dimensions: Millimeter. Converted Inch dimensions are not necessarily exact.

## Embossed Carrier Tape & Reel Specification — $\mu$ DFN-6

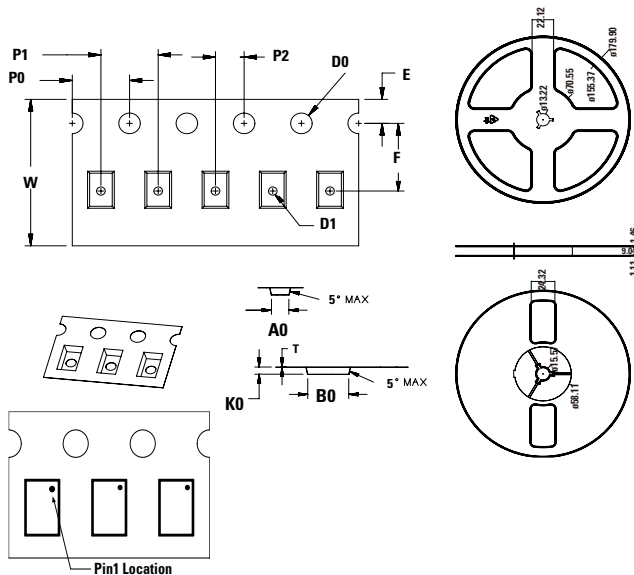

Symbol	Millimeters
A0	1.95 +/- 0.05
B0	2.30 +/- 0.05
D0	1.50 + 0.10
D1	Ø 0.60 + 0.05
E	1.75 +/- 0.10
F	3.50 +/- 0.05
K0	0.75 +/- 0.05
P0	4.00 +/- 0.10
P1	4.00 +/- 0.10
P2	2.00 +/- 0.05
T	0.25 +/- 0.02
W	8.00 + 0.30 /- 0.10

**Disclaimer Notice** - Information furnished is believed to be accurate and reliable. However, users should independently evaluate the suitability of and test each product selected for their own applications. Littelfuse products are not designed for, and may not be used in, all applications. Read complete Disclaimer Notice at <http://www.littelfuse.com/disclaimer-electronics>.