

SP2502L Series

3.3V 75A Diode Array

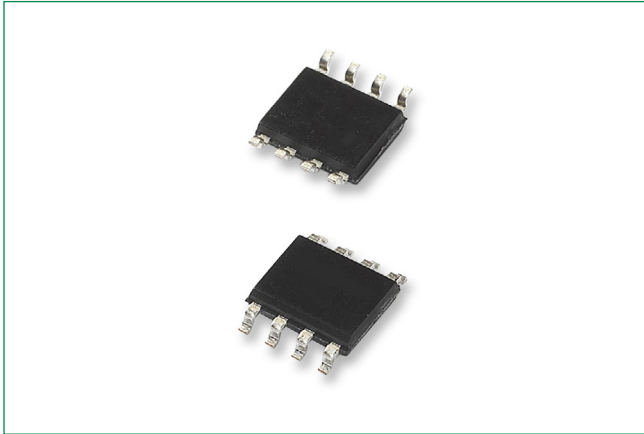

Additional Information



Resources



Accessories



Samples

Pinout

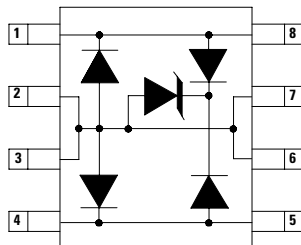

SOIC-8 (Top View)

Note: Pinout diagrams above shown as device footprint on circuit board.

Functional Block Diagram

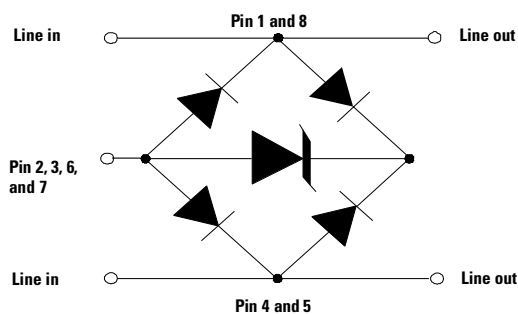

Life Support Note:

Not Intended for Use in Life Support or Life Saving Applications

The products shown herein are not designed for use in life sustaining or life saving applications unless otherwise expressly indicated.

Description

The SP2502L provides overvoltage protection for applications such as 10/100/1000 Base-T Ethernet and T3/E3 interfaces. This device has a low capacitance of only 5pF making it suitable for PHY side Ethernet protection and the capability to protect against both longitudinal and differential transients. Furthermore, the SP2502L is rated up to 100A ($t_p=2/10\mu s$) making it suitable for line side protection as well against lightning transients as defined by GR-1089 (intra-building), ITU, YD/T, etc. The application schematic provides the connection information for a PHY side protection scheme of a single differential pair.

Features & Benefits

- Lightning protection, IEC 61000-4-5, 75A (8/20 μs)
- Low clamping voltage
- Low insertion loss, log-linear capacitance
- Combined longitudinal and metallic protection
- Clamping speed of nanoseconds
- SOIC-8 surface mount package (JEDEC MS-012)
- Lead-Free and RoHS-Compliant

Applications

- T1/E1 Line cards
- 10/100/1000 BaseT Ethernet
- T3/E3 and DS3 Interfaces
- STS-1 Interfaces

Application Example

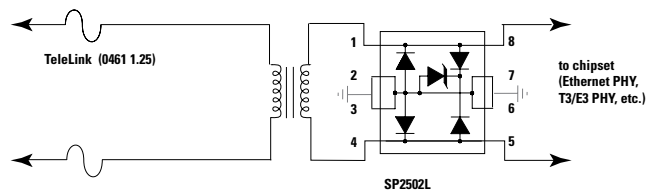

The schematic shows protection for a single differential pair as part of a larger high-speed data interface such as Ethernet. The SP2502L provides both metallic (differential) and longitudinal (common mode) protection from lightning induced surge events as specified by regulatory standards such as Telcordia's GR-1089 CORE and ITU K.20 and 21.

The SP2502L protects against both positive and negative induced surge events while the TeleLink fuse provides overcurrent protection for the long term 50/60 Hz power fault events.

SP2502L Series

3.3V 75A Diode Array

Absolute Maximum Ratings

Parameter	Rating	Units
Peak Pulse Current (8/20μs)	75	A
Peak Pulse Power (8/20μs)	2100	W
IEC 61000-4-2, Direct Discharge	30	kV
IEC 61000-4-2, Air Discharge	30	kV
Telcordia GR 1089 (Intra-Building) (2/10μs)	100	A
ITU K.20 (5/310μs)	20	A

Caution: Stresses above those listed in "Absolute Maximum Ratings" may cause permanent damage to the device. This is a stress only rating and operation of the device at these or any other conditions above those indicated in the operational sections of this specification is not implied.

Thermal Information

Parameter	Rating	Units
SOIC Package	170	°C/W
Operating Temperature Range	-40 to 125	°C
Storage Temperature Range	-55 to 150	°C
Maximum Junction Temperature	150	°C
Maximum Lead Temperature (Soldering 20-40s) (SOIC - Lead Tips Only)	260	°C

Electrical Characteristics (T_{OP} = 25°C)

Parameter	Symbol	Test Conditions	Min	Typ	Max	Units
Reverse Stand-Off Voltage	V _{RWM}	I _T ≤ 1 μA	-	-	3.3	V
Reverse Breakdown Voltage	V _{BR}	I _T = 2 μA	3.3	-	-	V
Snap Back Voltage	V _{SB}	I _T = 50 mA	3.3	-	-	V
Reverse Leakage Current	I _R	V _{RWM} = 3.3V	-	-	1	μA
Clamping Voltage, Line-Ground ¹	V _C	I _{PP} = 40A, t _p = 8/20 μs	-	-	14	V
Clamping Voltage, Line-Ground ¹	V _C	I _{PP} = 75A, t _p = 8/20 μs	-	-	20	V
Clamping Voltage, Line-Ground ¹	V _C	I _{PP} = 100A, t _p = 2/10 μs	-	-	20	V
Dynamic Resistance, Line-Ground ¹	R _{DYN}	(V _{C2} - V _{C1}) / (I _{PP2} - I _{PP1})	-	0.2	-	Ω
Clamping Voltage, Line-Line ¹	V _C	I _{PP} = 40A, t _p = 8/20 μs	-	-	20	V
Clamping Voltage, Line-Line ¹	V _C	I _{PP} = 75A, t _p = 8/20 μs	-	-	30	V
Clamping Voltage, Line-Line ¹	V _C	I _{PP} = 100A, t _p = 2/10 μs	-	-	30	V
Dynamic Resistance, Line-Line ¹	R _{DYN}	(V _{C2} - V _{C1}) / (I _{PP2} - I _{PP1})	-	0.3	-	Ω
Junction Capacitance ¹	C _J	Line to Ground, V _R = 0V, f = 1MHz	-	5	8	pF
		Line to Line, V _R = 0V, f = 1MHz	-	2.5	5	pF

Note: 1. Parameter is guaranteed by design and/or device characterization.

SP2502L Series

3.3V 75A Diode Array

Pulse Waveform

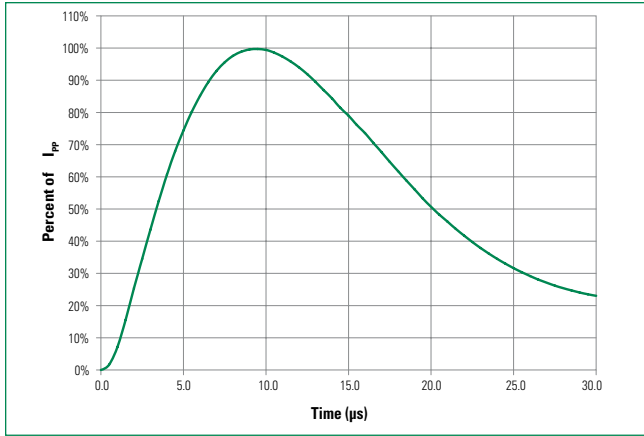

Clamping Voltage vs. IPP

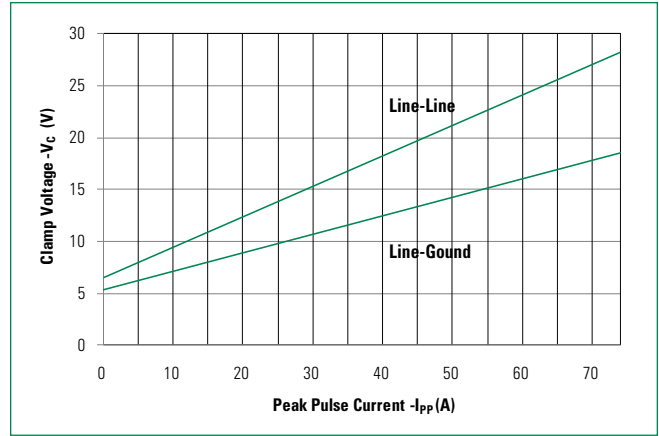

Capacitance vs. Reverse Bias at 1MHz

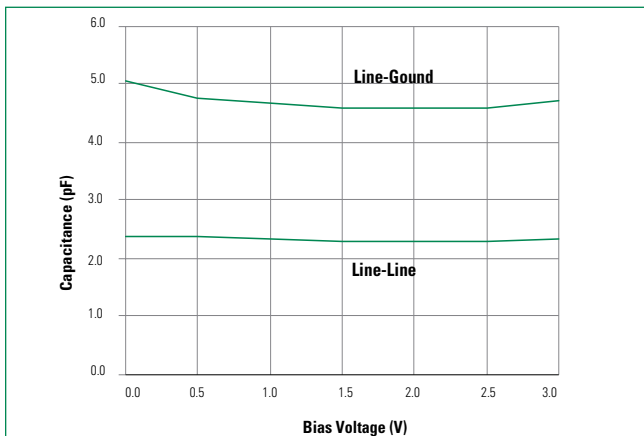

Current Derating Curve

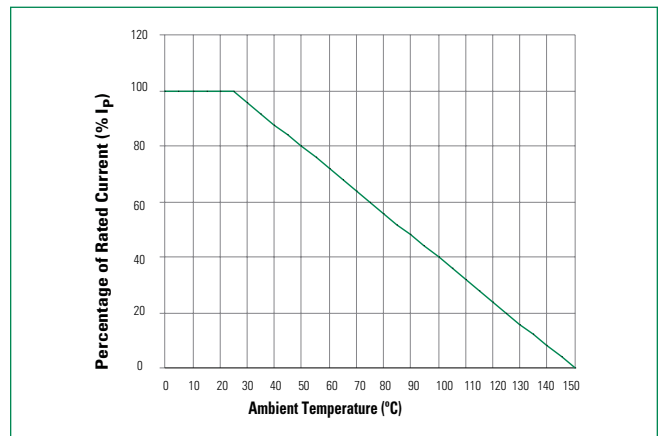

Non-Repetitive Peak Pulse Power vs. Pulse Time

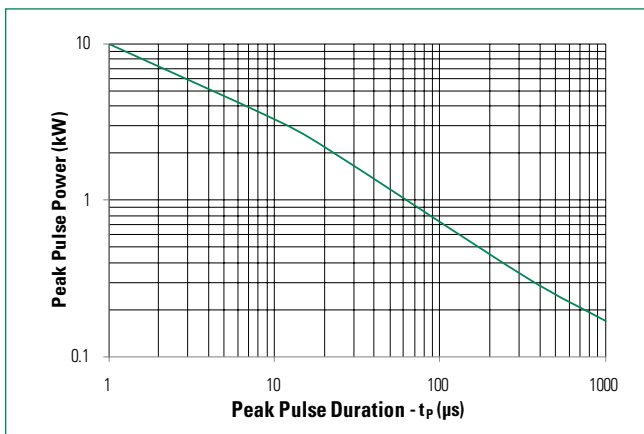

SP2502L Series

3.3V 75A Diode Array

Soldering Parameters

Reflow Condition		Pb – Free assembly
Pre Heat	- Temperature Min ($T_{s(min)}$)	150°C
	- Temperature Max ($T_{s(max)}$)	200°C
	- Time (min to max) (t_s)	60 – 180 secs
Average ramp up rate (Liquidus) Temp (T_L) to peak		3°C/second max
$T_{s(max)}$ to T_L - Ramp-up Rate		3°C/second max
Reflow	- Temperature (T_L) (Liquidus)	217°C
	- Temperature (t_l)	60 – 150 seconds
Peak Temperature (T_p)		260 ^{+0/-5} °C
Time within 5°C of actual peak Temperature (t_p)		20 – 40 seconds
Ramp-down Rate		6°C/second max
Time 25°C to peak Temperature (T_p)		8 minutes Max.
Do not exceed		260°C

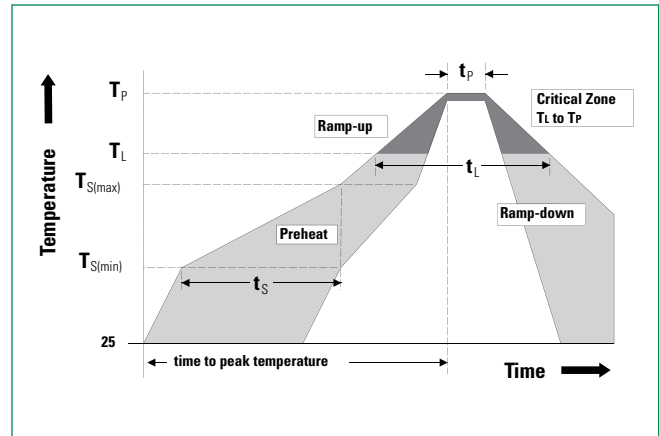

Part Marking System

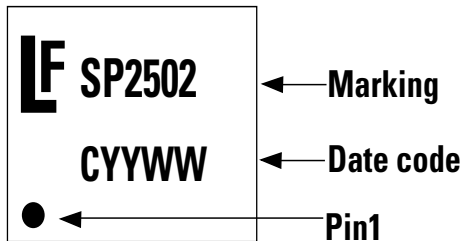

Product Characteristics

Lead Plating	Matte Tin
Lead Material	Copper Alloy
Lead Coplanarity	0.0004 inches (0.102mm)
Substitute Material	Silicon
Body Material	Molded Epoxy
Flammability	UL Recognized compound meeting flammability rating V-0

Part Numbering System

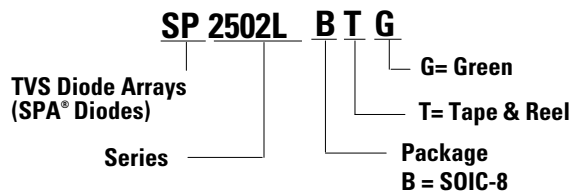

Ordering Information

Part Number	Package	Marking	Min. Order Qty.
SP2502LBTG	SOIC-8	SP2502	2500

SP2502L Series

3.3V 75A Diode Array

Package Dimensions — Mechanical Drawings and Recommended Solder Pad Outline

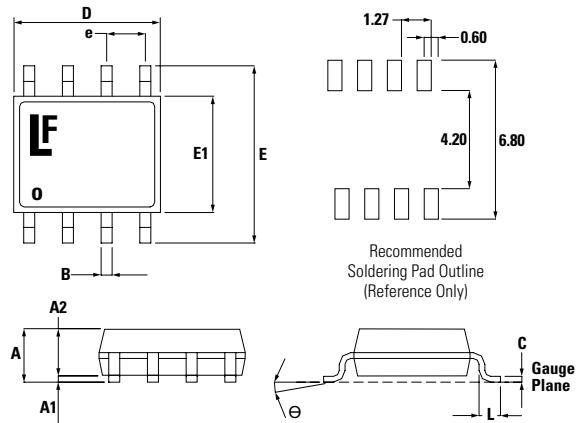

Package	SOIC			
Pins	8			
JEDEC	MS-012			
Symbol	Millimetres		Inches	
	Min	Max	Min	Max
A	1.35	1.75	0.053	0.069
A1	0.10	0.25	0.004	0.010
A2	1.25	1.65	0.050	0.065
B	0.31	0.51	0.012	0.020
c	0.17	0.25	0.007	0.010
D	4.80	5.00	0.189	0.197
E	5.80	6.20	0.228	0.244
E1	3.80	4.00	0.150	0.157
e	1.27 BSC		0.050 BSC	
L	0.40	1.27	0.016	0.050

Embossed Carrier Tape & Reel Specification — SOIC Package

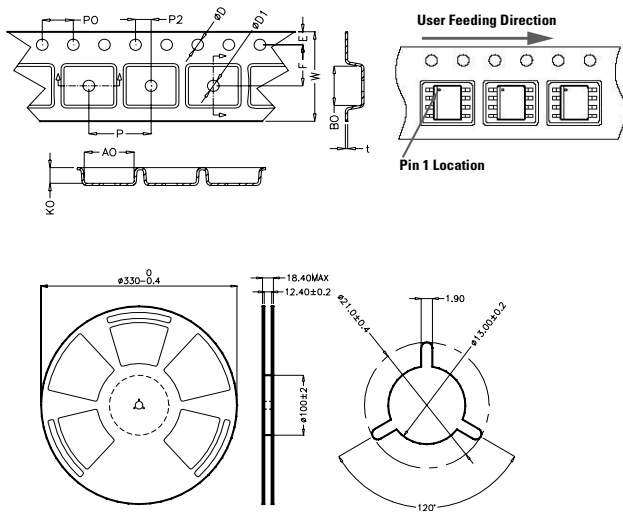

Symbol	Millimetres		Inches	
	Min	Max	Min	Max
E	1.65	1.85	0.065	0.073
F	5.4	5.6	0.213	0.22
P2	1.95	2.05	0.077	0.081
D	1.5	1.6	0.059	0.063
D1	1.50 Min		0.059 Min	
P0	3.9	4.1	0.154	0.161
10P0	40.0 ± 0.20		1.574 ± 0.008	
W	11.9	12.1	0.468	0.476
P	7.9	8.1	0.311	0.319
A0	6.3	6.5	0.248	0.256
B0	5.1	5.3	0.2	0.209
K0	2	2.2	0.079	0.087
t	0.30 ± 0.05		0.012 ± 0.002	

Disclaimer Notice - Information furnished is believed to be accurate and reliable. However, users should independently evaluate the suitability of and test each product selected for their own applications. Littelfuse products are not designed for, and may not be used in, all applications. Read complete Disclaimer Notice at www.littelfuse.com/disclaimer-electronics.