

# SP3019 Series

## Low Capacitance ESD Protection

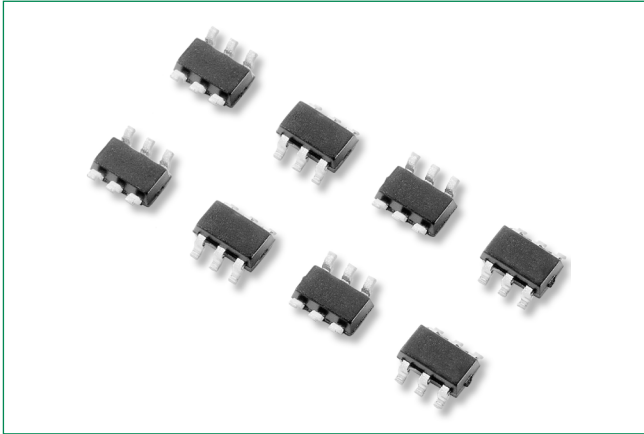

**Pinout**

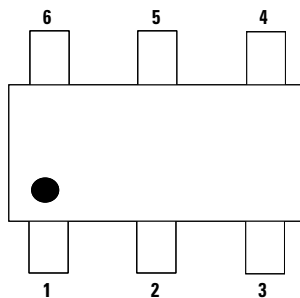

**Functional Block Diagram**

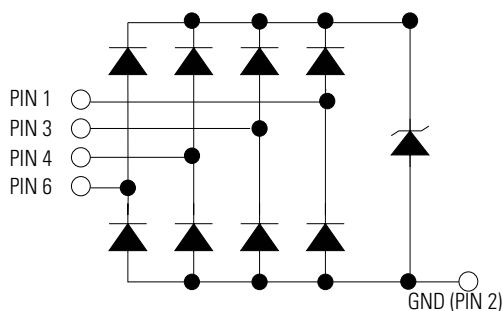

**Note:** PIN 5 is NC

Life Support Note:

**Not Intended for Use in Life Support or Life Saving Applications**

The products shown herein are not designed for use in life sustaining or life saving applications unless otherwise expressly indicated.

### Description

The SP3019 integrates 4 channels of ultra low capacitance asymmetrical protection for electronic equipment that may experience destructive electrostatic discharges (ESD). These robust components can safely absorb repetitive ESD strikes above the maximum contact level specified in IEC 61000-4-2 ( $\pm 8$ kV contact discharge) without performance degradation.

The extremely low off-state capacitance also makes it ideal for protecting high speed signal lines such as USB3.0, HDMI, USB2.0, and eSATA.

### Features & Benefits

- ESD, IEC 61000-4-2, +/-10kV contact, +/-15kV air
- EFT, IEC 61000-4-4, 40A (tP=5/50ns)
- Lightning, IEC 61000-4-5 2nd Edition, 2.5A (tp=8/20us)
- Low capacitance of 0.3pF @0V, 3GHz (TYP) per I/O
- Low leakage current of 10nA (TYP) at 5V
- AEC-Q101 qualified
- Moisture Sensitivity Level (MSL -1)
- Halogen free, lead free and RoHS compliant
- PPAP capable

### Applications

- LCD/PDP TVs
- External Storages
- DVD/Blu-ray Players
- Desktops
- MP3/PMP
- Set Top Boxes
- Smartphones
- Ultrabooks/Notebooks
- Digital Cameras

# SP3019 Series

## Low Capacitance ESD Protection

### Absolute Maximum Ratings

Symbol	Parameter	Value	Units
$I_{PP}$	Peak Current ( $t_p=8/20\mu s$ )	2.5	A
$T_{OP}$	Operating Temperature	-40 to 125	°C
$T_{STOR}$	Storage Temperature	-55 to 150	°C

**Caution:** Stresses above those listed in "Absolute Maximum Ratings" may cause permanent damage to the component. This is a stress only rating and operation of the component at these or any other conditions above those indicated in the operational sections of this specification is not implied.

### Electrical Characteristics ( $T_{OP}=25^{\circ}C$ )

Parameter	Symbol	Test Conditions	Min	Typ	Max	Units
Reverse Standoff Voltage	$V_{RWM}$	$I_R \leq 1\mu A$			5.0	V
Reverse Leakage Current	$I_{LEAK}$	$V_R=5V$ , Any I/O to GND		0.01	0.50	$\mu A$
Breakdown Voltage	$V_{BR}$	$I_R=1mA$		8.2		V
Clamp Voltage <sup>1</sup>	$V_C$	$I_{PP}=1A$ , $t_p=8/20\mu s$ , Fwd		10.5		V
		$I_{PP}=2A$ , $t_p=8/20\mu s$ , Fwd		11.5		V
Dynamic Resistance <sup>2</sup>	$R_{DYN}$	TLP, $t_p=100ns$ , I/O to GND		0.64		$\Omega$
ESD Withstand Voltage <sup>1</sup>	$V_{ESD}$	IEC 61000-4-2 (Contact)	+/- 10			kV
		IEC 61000-4-2 (Air)	+/- 15			kV
Diode Capacitance <sup>1</sup>	$C_{I/O-GND}$	Reverse Bias=0V, $f=3GHz$		0.3		$\mu F$
	$C_{I/O-I/O}$			0.18		

**Note:**

- Parameter is guaranteed by design and/or component characterization.
- Transmission Line Pulse (TLP) with 100ns width, 2ns rise time, and average window  $t_1=70ns$  to  $t_2=90ns$

#### Positive Transmission Line Pulsing(TLP) Plot

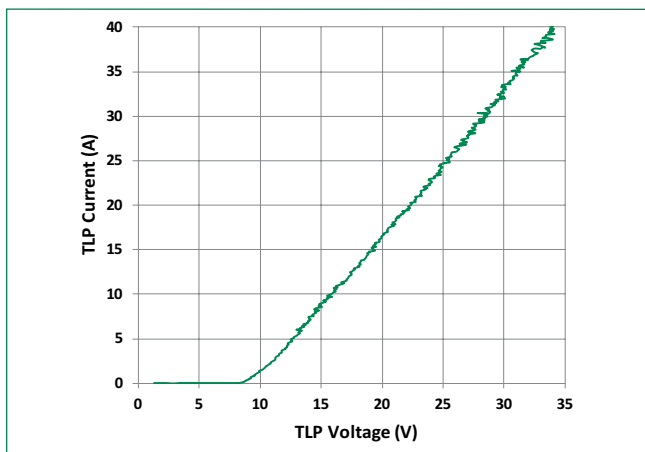

#### Positive Transmission Line Pulsing(TLP) Plot

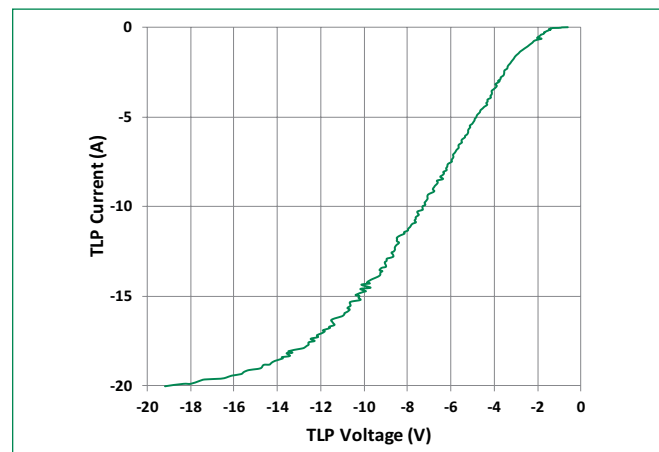

# SP3019 Series

## Low Capacitance ESD Protection

Clamping Voltage vs. IPP for 8/20µs Waveshape

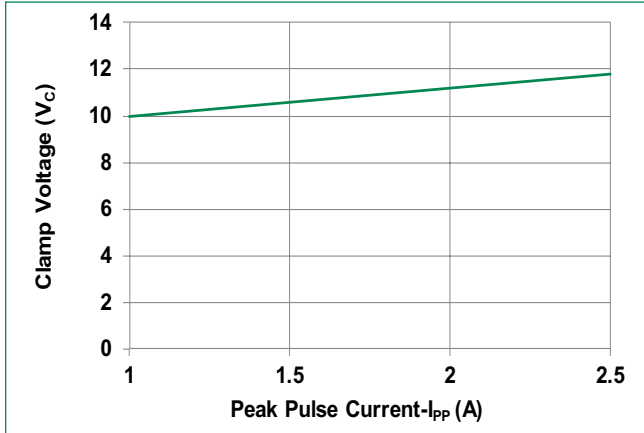

8/20 µs Pulse Waveform

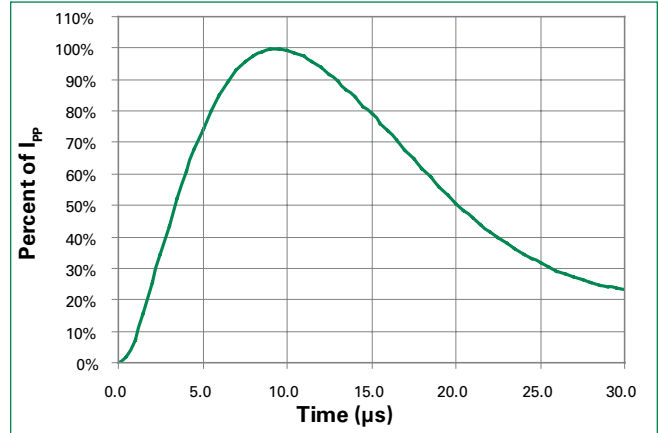

IEC 61000-4-2 +8 kV Contact ESD Clamping Voltage

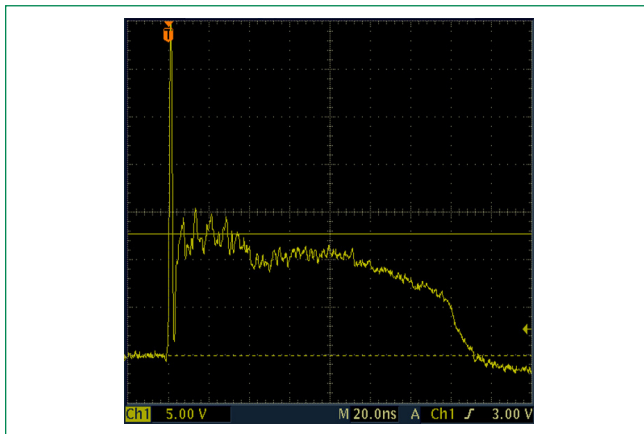

IEC 61000-4-2 -8 kV Contact ESD Clamping Voltage

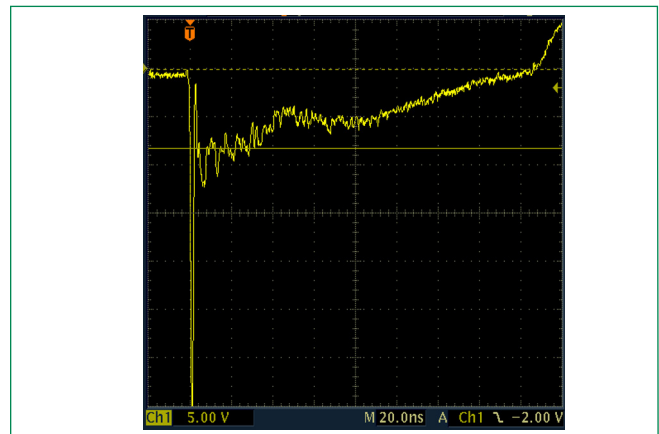

# SP3019 Series

## Low Capacitance ESD Protection

### Soldering Parameters

<b>Reflow Condition</b>		Pb – Free assembly
<b>Pre Heat</b>	- Temperature Min ( $T_{s(min)}$ )	150°C
	- Temperature Max ( $T_{s(max)}$ )	200°C
	- Time (min to max) ( $t_p$ )	60 – 120 secs
<b>Average ramp up rate (Liquidus) Temp (<math>T_L</math>) to peak</b>		3°C/second max
<b><math>T_{s(max)}</math> to <math>T_L</math> - Ramp-up Rate</b>		3°C/second max
<b>Reflow</b>	- Temperature ( $T_L$ ) (Liquidus)	217°C
	- Temperature ( $t_L$ )	60 – 150 seconds
<b>Peak Temperature (<math>T_p</math>)</b>		260 <sup>+0/-5</sup> °C
<b>Time within 5°C of actual peak Temperature (<math>t_p</math>)</b>		30 seconds
<b>Ramp-down Rate</b>		6°C/second max
<b>Time 25°C to peak Temperature (<math>T_p</math>)</b>		8 minutes Max.
<b>Do not exceed</b>		260°C

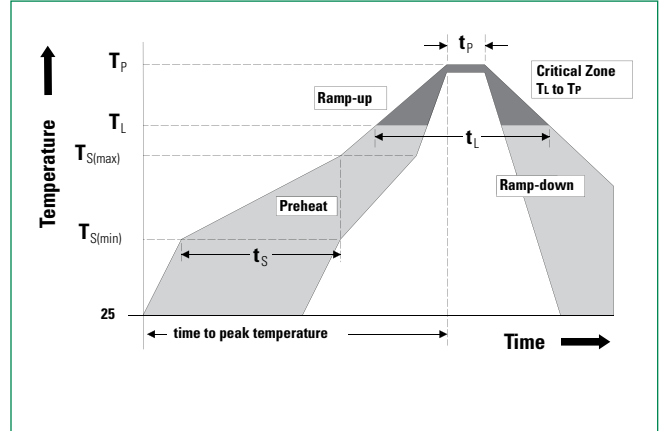

### Ordering Information

Part Number	Package	Min. Order Qty.
SP3019-04HTG	SOT23-6	3000

### Product Characteristics

<b>Lead Plating</b>	Matte tin
<b>Lead Material</b>	Copper Alloy
<b>Lead Coplanarity</b>	0.0004 inches (0.102mm)
<b>Substrate material</b>	Silicon
<b>Body Material</b>	Molded Compound
<b>Flammability</b>	UL Recognized compound meeting flammability rating V-0

### Part Marking System

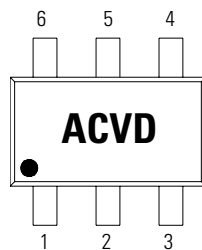

AC : Part code  
V : Assembly code  
D : Date code

### Part Numbering System

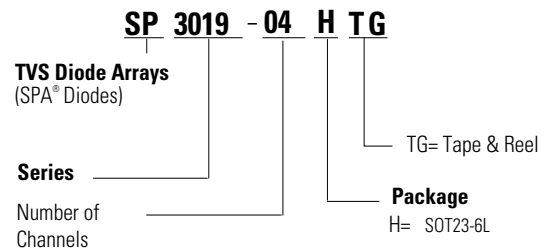

# SP3019 Series

## Low Capacitance ESD Protection

### Package Dimensions – SOT23-6L

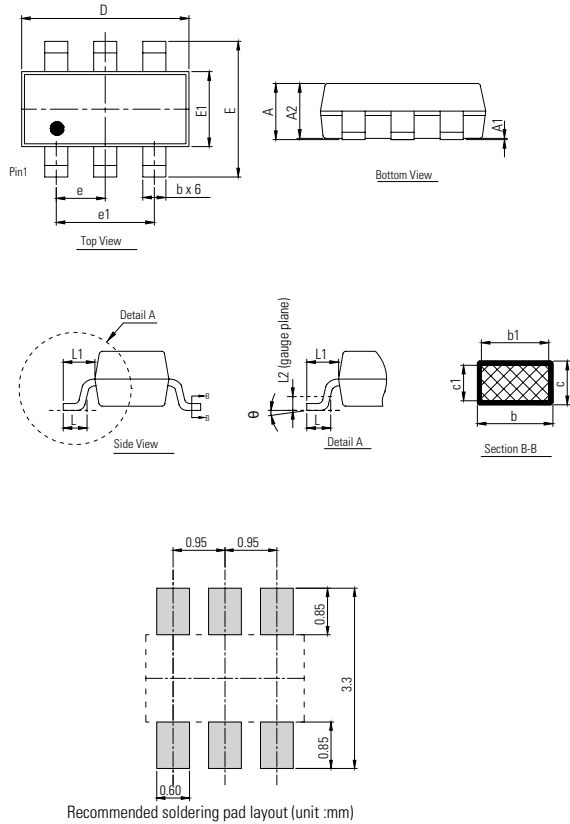

Symbol	Millimeters		
	Min	Nom	Max
<b>A</b>	-	-	1.45
<b>A1</b>	0.00	-	0.15
<b>A2</b>	0.90	1.15	1.30
<b>b</b>	0.25	-	0.50
<b>b1</b>	0.25	0.40	0.45
<b>c</b>	0.08	-	0.22
<b>c1</b>	0.08	0.13	0.20
<b>D</b>	2.75	2.90	3.05
<b>E</b>	2.60	2.80	3.00
<b>E1</b>	1.45	1.60	1.75
<b>e</b>	0.95 BSC		
<b>e1</b>	1.90 BSC		
<b>L</b>	0.30	0.50	0.60
<b>L1</b>	0.60 REF		
<b>L2</b>	0.25 BSC		
$\theta$	0°	4°	8°

### Embossed Carrier Tape & Reel Specification – SOT23-6L

#### 8mm TAPE AND REEL

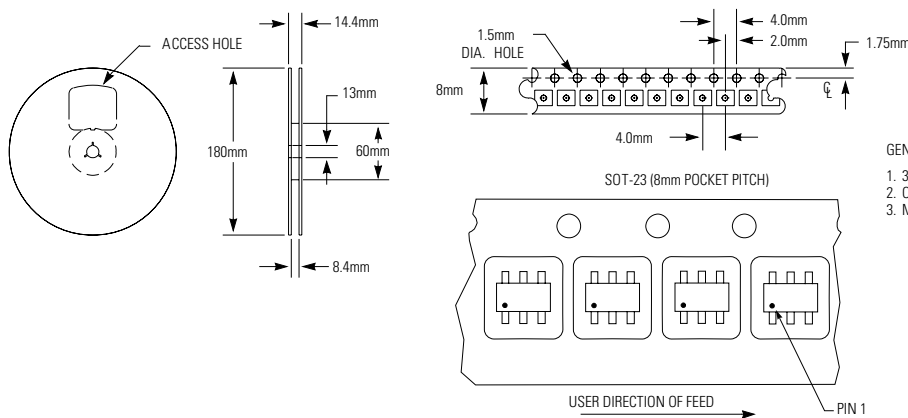

**Disclaimer Notice** - Information furnished is believed to be accurate and reliable. However, users should independently evaluate the suitability of and test each product selected for their own applications. Littelfuse products are not designed for, and may not be used in, all applications. Read complete Disclaimer Notice at <http://www.littelfuse.com/disclaimer-electronics>.