

# SP3051 Series

## 6V 20A Diode Array

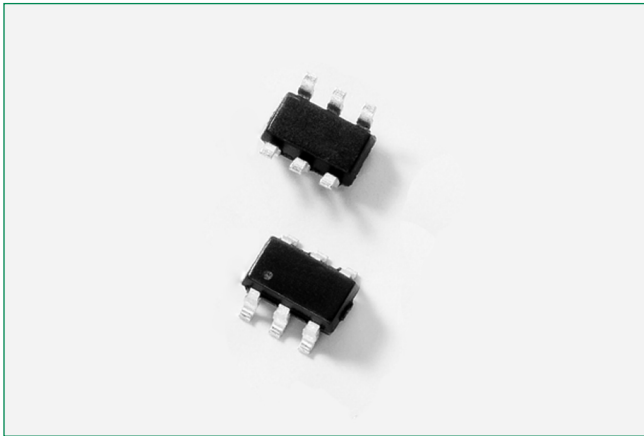

### Description

The SP3051 integrates low capacitance rail-to-rail diodes with an additional zener diode to protect each I/O pin against ESD and high surge events. This robust component can safely absorb 20A of current per IEC 61000-4-5 ( $t_P=8/20\mu s$ ) without performance degradation and a minimum  $\pm 30kV$  ESD rating per IEC 61000-4-2 2nd edition. Their very low off-state capacitance is compatible with high speed circuits.

### Features and Benefits

- ESD, IEC 61000-4-2,  $\pm 30kV$  contact,  $\pm 30kV$  air
- EFT, IEC 61000-4-4, 40A (5/50ns)
- Lightning, 20A (8/20 $\mu s$  as defined in IEC 61000-4-5 2<sup>nd</sup> edition)
- Low off-state capacitance of 3.8pF (TYP) per I/O
- Low leakage current of 0.5 $\mu A$  (MAX) at 5V
- Small SOT23-6 (JEDEC MO-178AB) packaging

### Additional Information



Resources



Accessories



Samples

### Pinout

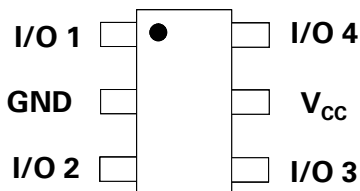

### Functional Block Diagram

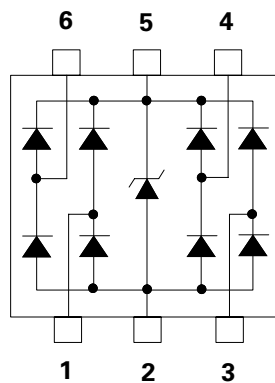

### Applications

- LCD/PDP TVs
- Monitors
- Notebooks
- 10/100/1000 Ethernet
- Firewire
- Set Top Boxes
- Flat Panel Displays
- Portable Medical

### Application Examples

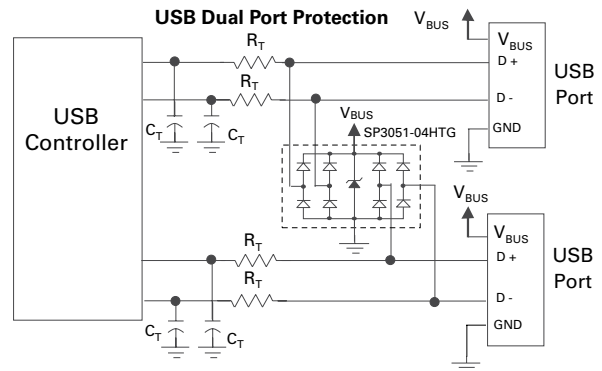

### 10/100/1000 Ethernet Protection

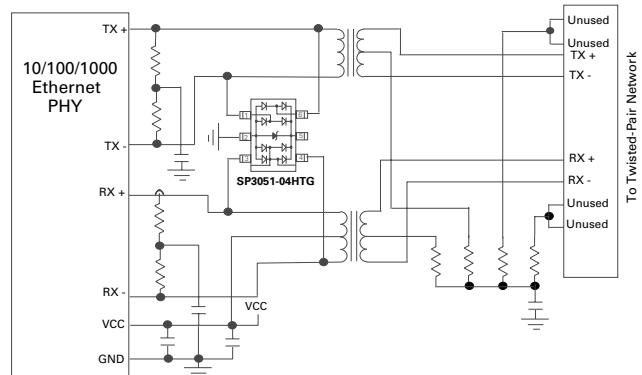

Life Support Note:

**Not Intended for Use in Life Support or Life Saving Applications**

The products shown herein are not designed for use in life sustaining or life saving applications unless otherwise expressly indicated.

\*Note: 1000Mbps Ethernet, or 1GbE, will require 8 channels of protection (4 differential pair) so the solution above should be replicated for the additional 2 differential pair.

# SP3051 Series

## 6V 20A Diode Array

### Absolute Maximum Ratings

Symbol	Parameter	Value	Units
$I_{PP}$	Peak Current ( $t_p=8/20\mu s$ )	20	A
$P_{PK}$	Peak Pulse Power ( $t_p=8/20\mu s$ )	400	W
$T_{OP}$	Operating Temperature	-40 to 125	°C
$T_{STOR}$	Storage Temperature	-55 to 150	°C

**Caution:** Stresses above those listed in "Absolute Maximum Ratings" may cause permanent damage to the component. This is a stress only rating and operation of the component at these or any other conditions above those indicated in the operational sections of this specification is not implied.

### Electrical Characteristics ( $T_{OP}=25^\circ C$ )

Parameter	Symbol	Test Conditions	Min	Typ	Max	Units
Reverse Standoff Voltage	$V_{RWM}$	$I_R = 1\mu A$			6.0	V
Breakdown Voltage	$V_R$	$I_R = 1mA$		8.0		V
Reverse Leakage Current	$I_{LEAK}$	$V_R=5V$		0.1	0.5	$\mu A$
Clamp Voltage <sup>1</sup>	$V_C$	$I_{PP}=1A, t_p=8/20\mu s, I/O$ to GND <sup>3</sup>		9.0	10.5	V
		$I_{PP}=10A, t_p=8/20\mu s, I/O$ to GND <sup>3</sup>		11.5	15.0	V
		$I_{PP}=20A, t_p=8/20\mu s, I/O$ to GND <sup>3</sup>		14.3	17.0	V
Dynamic Resistance <sup>2</sup>	$R_{DYN}$	TLP, $t_p=100ns, I/O$ to GND		0.2		$\Omega$
ESD Withstand Voltage <sup>1</sup>	$V_{ESD}$	IEC 61000-4-2 (Contact)	$\pm 30$			kV
		IEC 61000-4-2 (Air)	$\pm 30$			kV
Diode Capacitance <sup>1</sup>	$C_{I/O-GND}$	Reverse Bias=0V, f=1MHz		3.8	4.2	pF
		$V_{CC}=5V$ , Reverse Bias=2.5V, f=1MHz		1.7	2.0	pF
Diode Capacitance <sup>1</sup>	$C_{I/O-I/O}$	Reverse Bias=0V		2.0		pF

**Notes:** <sup>1</sup> Parameter is guaranteed by design and/or component characterization.

<sup>2</sup> Repetitive pulse per waveform shown on page 3.

<sup>3</sup> Transmission Line Pulse (TLP) with 100ns width, 2ns rise time, and average window  $t_1=70ns$  to  $t_2=90ns$

#### Capacitance vs. Reverse Voltage

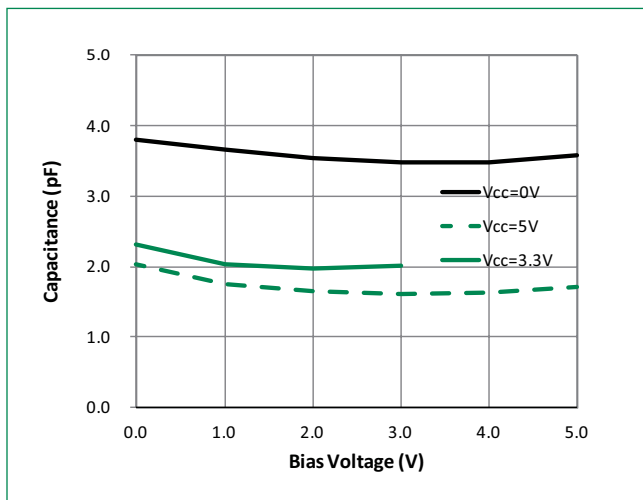

#### Clamping Voltage vs. Peak Pulse Current

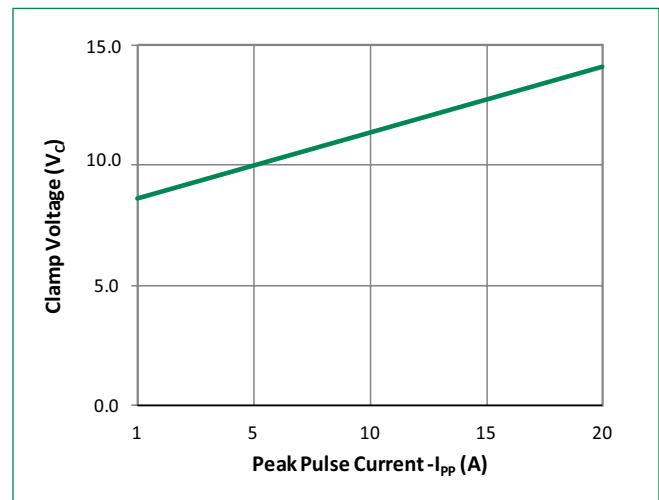

# SP3051 Series

## 6V 20A Diode Array

8/20µs Pulse Waveform

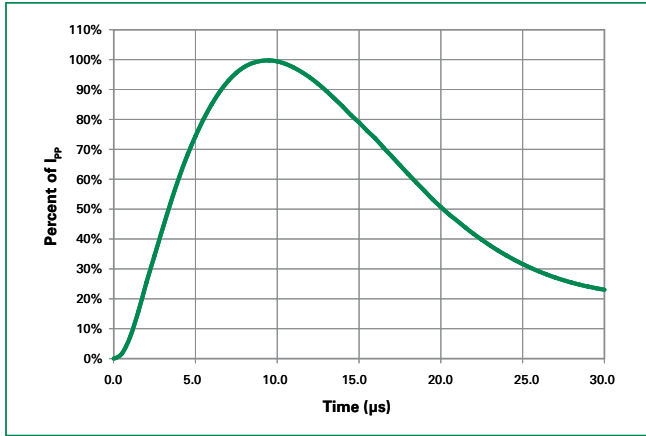

Transmission Line Pulsing(TLP) Plot

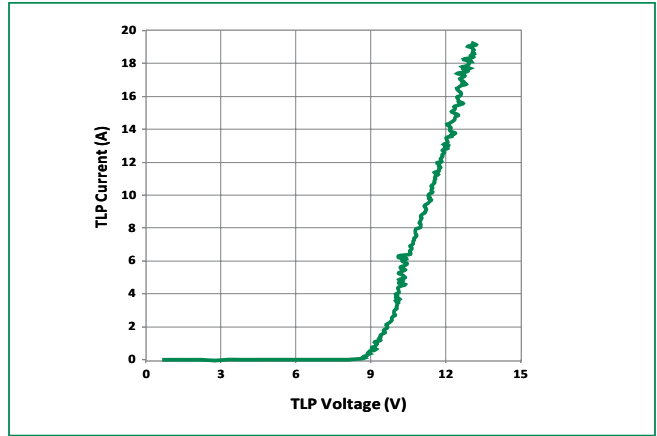

IEC 61000 -4-2 +8 kV Contact ESD Clamping Voltage

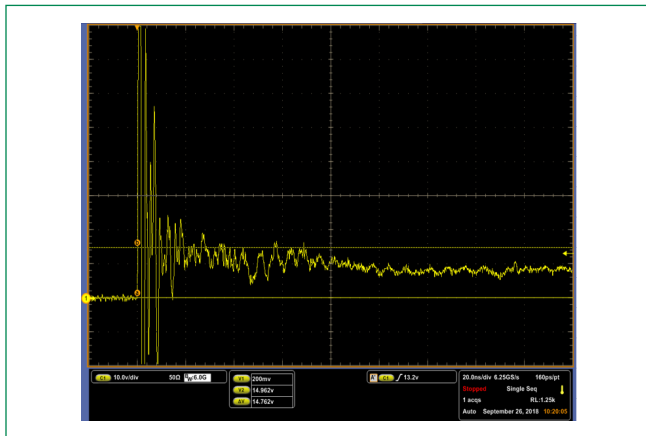

IEC 61000 -4-2 -8 kV Contact ESD Clamping Voltage

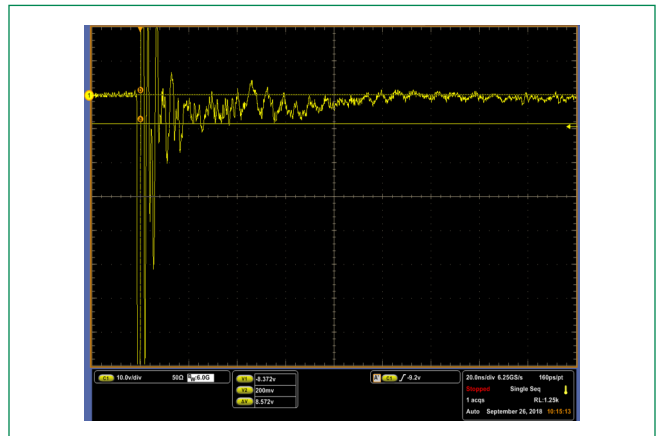

# SP3051 Series

## 6V 20A Diode Array

### Soldering Parameters

<b>Reflow Condition</b>		Pb – Free assembly
<b>Pre Heat</b>	- Temperature Min ( $T_{s(min)}$ )	150°C
	- Temperature Max ( $T_{s(max)}$ )	200°C
	- Time (min to max) ( $t_s$ )	60 – 180 secs
<b>Average ramp up rate (Liquidus) Temp (<math>T_L</math>) to peak</b>		3°C/second max
<b><math>T_{s(max)}</math> to <math>T_L</math> - Ramp-up Rate</b>		3°C/second max
<b>Reflow</b>	- Temperature ( $T_L$ ) (Liquidus)	217°C
	- Temperature ( $t_L$ )	60 – 150 seconds
<b>Peak Temperature (<math>T_p</math>)</b>		260 <sup>+0/-5</sup> °C
<b>Time within 5°C of actual peak Temperature (<math>t_p</math>)</b>		20 – 40 seconds
<b>Ramp-down Rate</b>		6°C/second max
<b>Time 25°C to peak Temperature (<math>T_p</math>)</b>		8 minutes Max.
<b>Do not exceed</b>		260°C

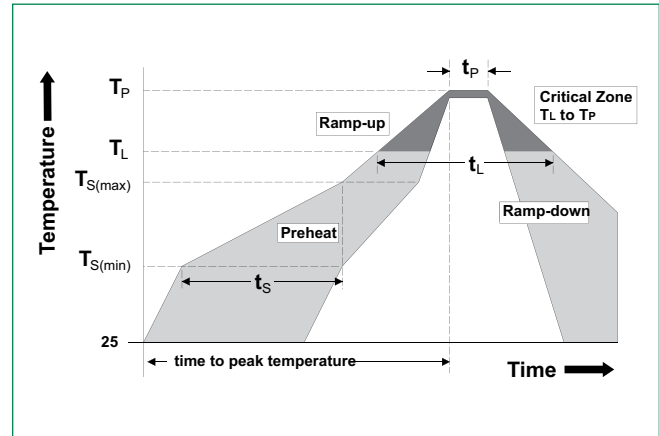

### Part Numbering System

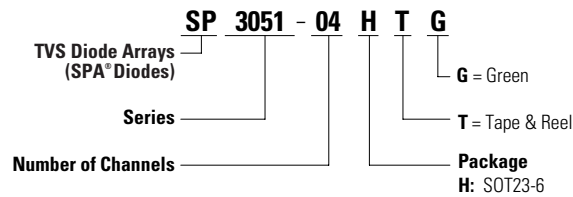

### Product Characteristics

<b>Lead Plating</b>	Tin
<b>Lead Material</b>	Copper Alloy
<b>Lead Coplanarity</b>	0.004 inches(0.102mm)
<b>Substrate Material</b>	Silicon
<b>Body Material</b>	Molded Compound
<b>Flammability</b>	UL Recognized compound meeting flammability rating V-0

### Ordering Information

Part Number	Package	Min. Order Qty.
SP3051-04HTG	SOT23-6	3000

### Part Marking System

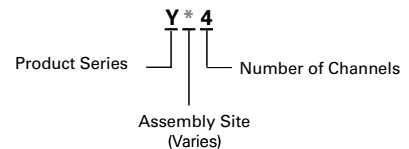
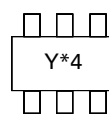

# SP3051 Series

## 6V 20A Diode Array

### Package Dimensions – SOT23-6

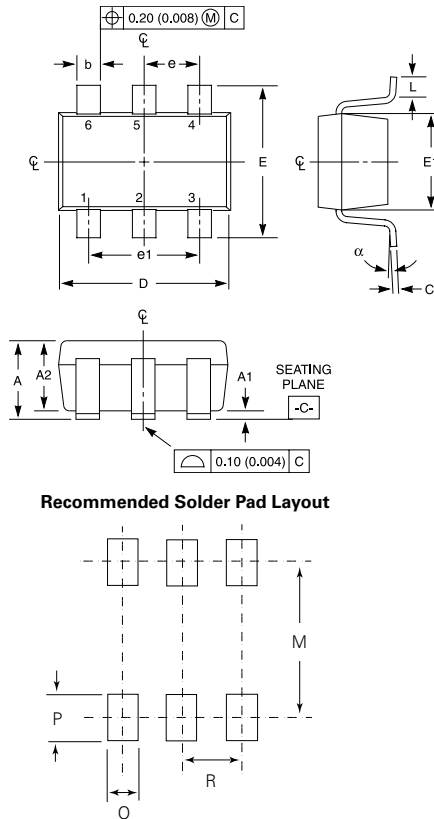

Package	SOT23				Notes
Pins	6				
JEDEC	MO-178AB				
	Millimeters		Inches		
	Min	Max	Min	Max	
A	0.900	1.450	0.035	0.057	-
A1	0.000	0.150	0.000	0.006	-
A2	0.900	1.300	0.035	0.051	-
b	0.350	0.500	0.0138	0.0196	-
C	0.080	0.220	0.0031	0.009	-
D	2.800	3.000	0.11	0.118	3
E	2.600	3.000	0.102	0.118	-
E1	1.500	1.750	0.06	0.069	3
e	0.95 Ref		0.0374 ref		-
e1	1.9 Ref		0.0748 Ref		-
L	0.30	0.600	0.012	0.023	4,5
N	6		6		6
a	0°	8°	0°	8°	-
M	-	2.590	-	0.102	-
O	-	0.690	-	.027 TYP	-
P	-	0.990	-	.039 TYP	-
R	-	0.950	-	0.038	-

#### Notes:

1. Dimensioning and tolerancing Per ASME Y14.5M-1994.
2. Package conforms to EIAJ SC-74 (1992).
3. Dimensions D and E1 are exclusive of mold flash, protrusions, or gate burrs.
4. Foot length L measured at reference to seating plane.
5. "L" is the length of flat foot surface for soldering to substrate.
6. "N" is the number of terminal positions.
7. Controlling dimension: MILLIMETER. Converted inch dimensions are not necessarily exact.

### Embossed Carrier Tape & Reel Specification – SOT23-6

#### 8mm TAPE AND REEL

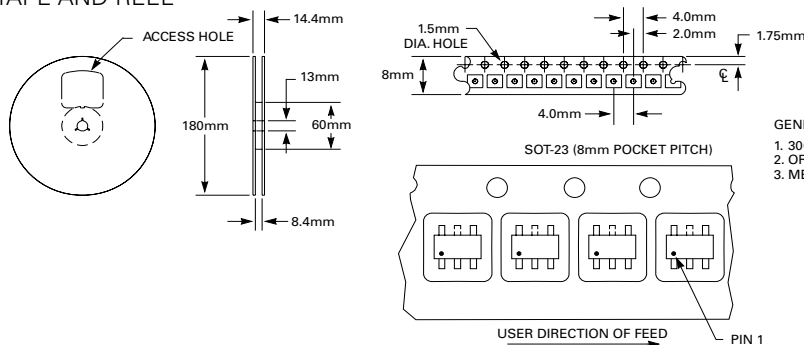

**Disclaimer Notice** - Information furnished is believed to be accurate and reliable. However, users should independently evaluate the suitability of and test each product selected for their own applications. Littelfuse products are not designed for, and may not be used in, all applications. Read complete Disclaimer Notice at <http://www.littelfuse.com/disclaimer-electronics>.