

SP3130E-01WTG

28 V, 0.3 pF, 30 kV, WLCSP0201, Bidirectional TVS, Ultra Low Capacitance ESD Protection

HF RoHS Pb

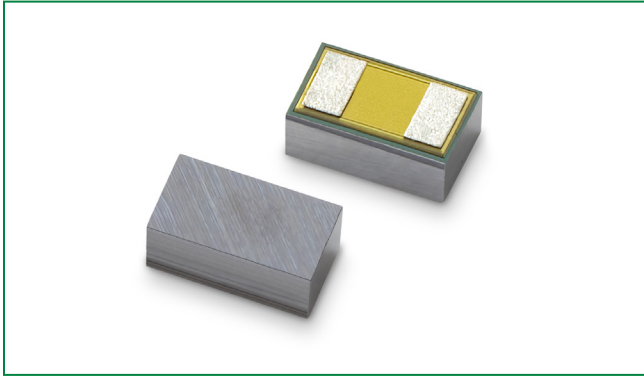

Pinout

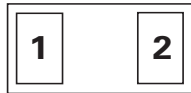

Functional Block Diagram



Description

The SP3130E-01WTG provides ultra-low capacitance, bidirectional and a high level of protection for electronic equipment that may experience destructive electrostatic discharges (ESD). The typical capacitance of 0.3 pF helps ensure excellent signal integrity on the most challenging consumer electronics interfaces.

It can safely absorb repetitive ESD strikes at ± 30 kV (contact discharge, IEC 61000-4-2) without performance degradation and safely dissipate 3.0 A of 8/20 μ s surge current (IEC 61000-4-5 2nd edition).

Features

- ESD, IEC 61000-4-2, ± 30 kV contact/air
- EFT, IEC 61000-4-4, 40 A (5/50 ns)
- Maximum surge tolerance, IEC 61000-4-5 2nd edition, 3.0 A (8/20 μ s)
- Ultra low capacitance of 0.3 pF (Typ @ $V_R = 0$ V)
- Low leakage current of 1 nA (Typ) at 28 V
- Halogen-free, lead-free and RoHS compliant
- Moisture Sensitivity Level (MSL-1)

Applications

- USB 2.0, USB 3.0
- Near Field Communications
- RF Signal ESD Protection
- RF Switching, Power Amplifier and Antenna ESD Protection

Life Support Note:

Not Intended for Use in Life Support or Life Saving Applications

The products shown herein are not designed for use in life sustaining or life saving applications unless otherwise expressly indicated.

SP3130E-01WTG

28 V, 0.3 pF, 30 kV, WLCSP0201, Bidirectional TVS, Ultra Low Capacitance ESD Protection

Absolute Maximum Ratings

Symbol	Parameter	Value	Units
I_{PP}	Peak Current ($t_p = 8/20 \mu s$)	3.0	A
T_{OP}	Operating Temperature	-40 to 125	°C
T_{STOR}	Storage Temperature	-55 to 150	°C

CAUTION: Stresses above those listed in "Absolute Maximum Ratings" may cause permanent damage to the component. This is a stress only rating and operation of the component at these or any other conditions above those indicated in the operational sections of this specification is not implied.

Electrical Characteristics ($T_{OP} = 25 \text{ }^\circ\text{C}$)

Parameter	Symbol	Test Conditions	Min	Typ	Max	Units
Reverse Standoff Voltage	V_{RWM}				28	V
Breakdown Voltage	V_{BR}	$I_R = 1 \text{ mA}$	30	35	40	V
Reverse Leakage Current	I_{LEAK}	$V_R = 28 \text{ V}$		1	50	nA
Clamp Voltage ¹	V_C	$I_{PP} = 1 \text{ A}$, $t_p = 8/20 \mu s$, I/O to GND		39	44	V
		$I_{PP} = 3 \text{ A}$, $t_p = 8/20 \mu s$, I/O to GND		42	48	V
Dynamic Resistance ^{1,2}	R_{DYN}	TLP, $t_p = 100 \text{ ns}$, I/O to GND		0.65		Ω
ESD Withstand Voltage ^{1,3}	V_{ESD}	IEC 61000-4-2 (Contact Discharge)	± 30			kV
		IEC 61000-4-2 (Air Discharge)	± 30			kV
Diode Capacitance ¹	C_{IO-GND}	Reverse Bias = 0 V, $f = 1 \text{ MHz}$, I/O to GND		0.30	0.45	pF

Note:

- Parameter is guaranteed by design and/or component characterization.
- Transmission Line Pulse (TLP) with 100ns width, 0.2 ns rise time, and average window $t_1 = 70 \text{ ns}$ to $t_2 = 90 \text{ ns}$
- Device stressed with ten non-repetitive ESD pulses.

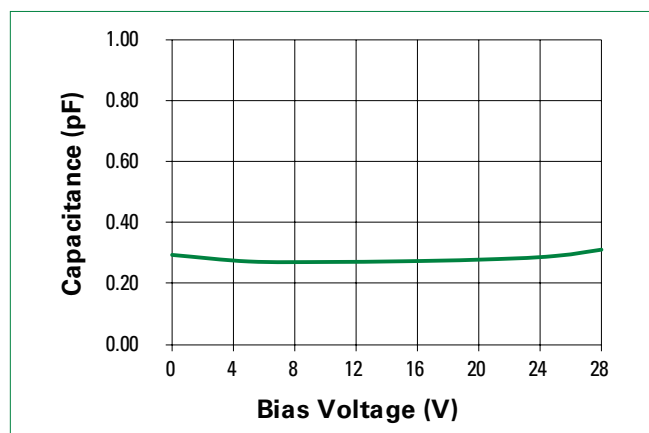
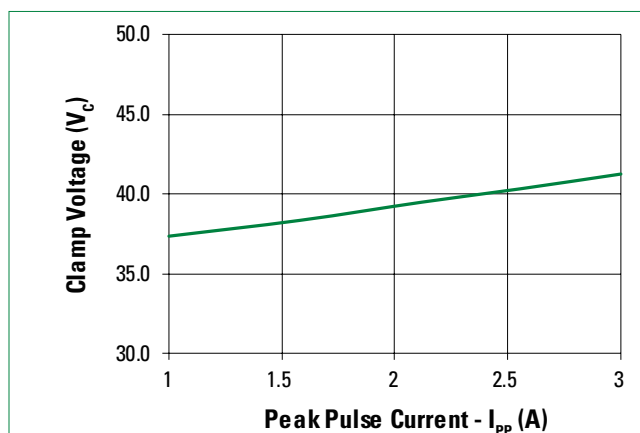
Capacitance vs. Reverse Bias**Clamping Voltage vs I_{PP}** 

SP3130E-01WTG

28 V, 0.3 pF, 30 kV, WLCSP0201, Bidirectional TVS, Ultra Low Capacitance ESD Protection

Positive Transmission Line Pulsing (TLP) Plot

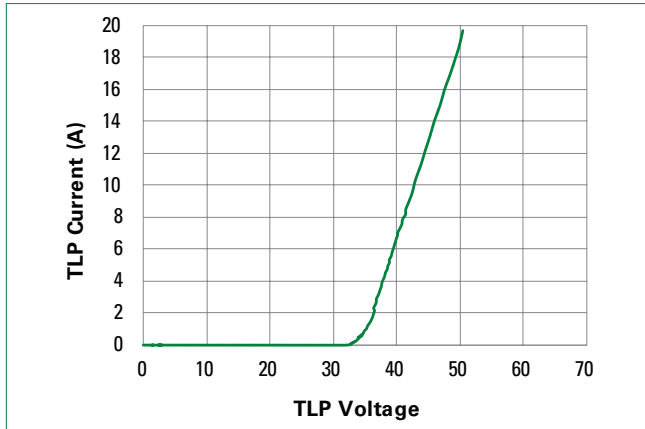

Negative Transmission Line Pulsing (TLP) Plot

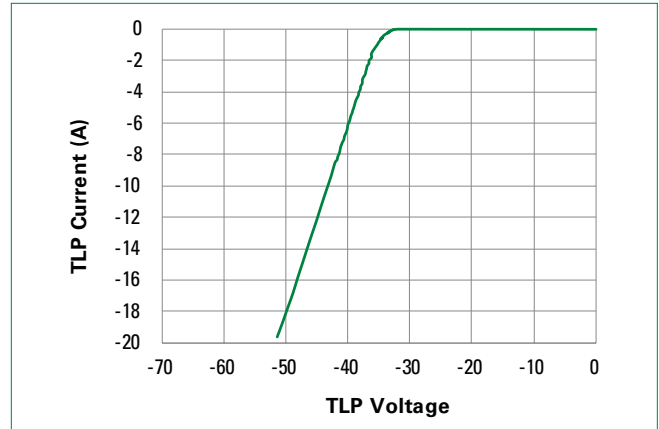

IEC 61000-4-2 +8 kV Contact ESD Clamping Voltage

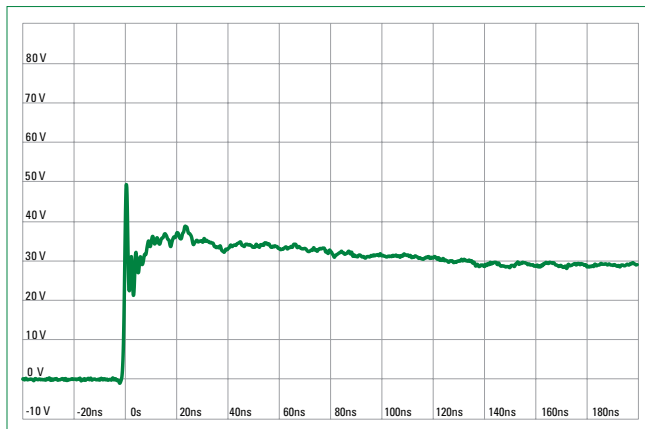

IEC 61000-4-2 -8 kV Contact ESD Clamping Voltage

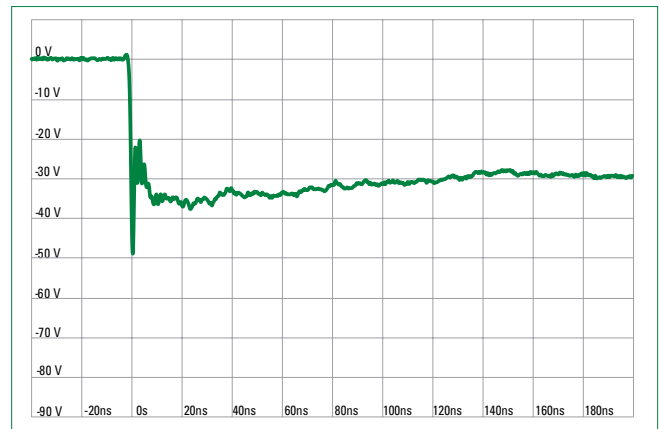

SP3130E-01WTG

28 V, 0.3 pF, 30 kV, WLCSP0201, Bidirectional TVS, Ultra Low Capacitance ESD Protection

Soldering Parameters

Reflow Condition		Pb – Free assembly
Pre Heat	- Temperature Min ($T_{s(min)}$)	150 °C
	- Temperature Max ($T_{s(max)}$)	200 °C
	- Time (min to max) (t_s)	60 – 120 seconds
Average Ramp up Rate (Liquidus) Temp (T_L) to Peak		3 °C/second max
$T_{s(max)}$ to T_L - Ramp-up Rate		3 °C/second max
Reflow	- Temperature (T_L) (Liquidus)	217 °C
	- Temperature (t_L)	60 – 150 seconds
Peak Temperature (T_p)		260 ^{+0/-5} °C
Time within 5 °C of Actual Peak Temperature (t_p)		30 seconds
Ramp-down Rate		6 °C/second max
Time 25 °C to Peak Temperature (T_p)		8 minutes max
Do not exceed		260 °C

Ordering Information

Part Number	Package	Min. Order Qty.
SP3130E-01WTG	WLCSP0201	10,000

Part Marking System

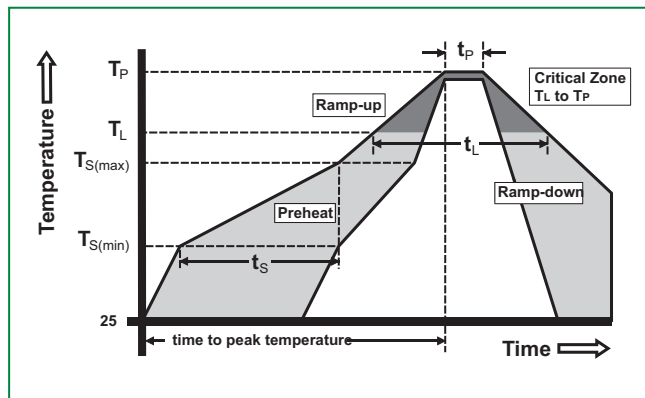

Product Characteristics

Lead plating	Tin plating
Lead material	Copper bump
Flammability	UL recognized compound meeting flammability rating V-0

Part Numbering System

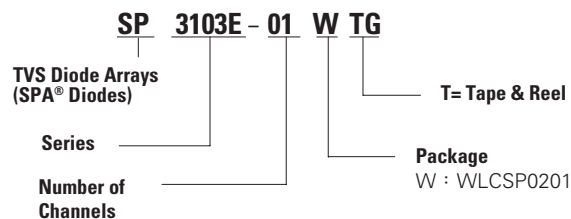

SP3130E-01WTG

28 V, 0.3 pF, 30 kV, WLCSP0201, Bidirectional TVS, Ultra Low Capacitance ESD Protection

Package Dimensions — WLCSP0201

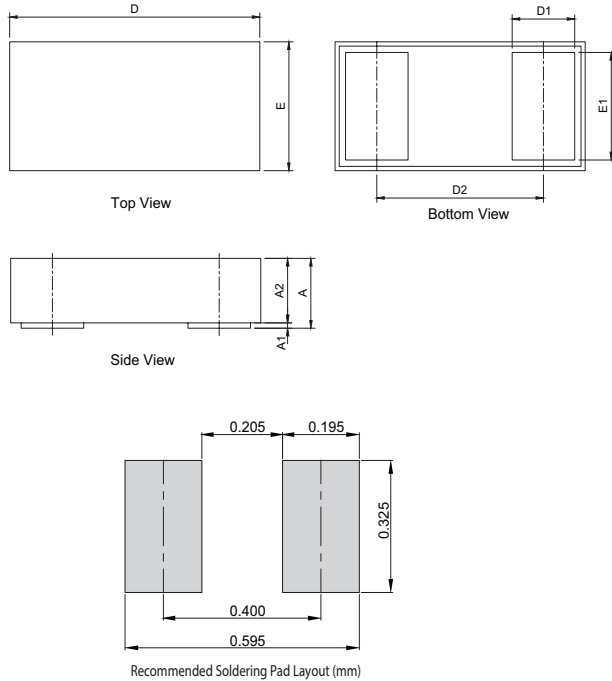

Symbol	Millimeters		Inches	
	Min	Max	Min	Max
D	0.605	0.655	0.0238	0.0258
E	0.305	0.355	0.0120	0.0140
D1	0.145	0.155	0.0057	0.0061
E1	0.245	0.255	0.0096	0.0100
D2	0.400 BSC		0.0157 BSC	
A	0.273	0.329	0.0107	0.0130
A2	0.265	0.315	0.0104	0.0124
A1	0.008	0.014	0.0003	0.0006

Embossed Carrier Tape & Reel Specification — WLCSP0201

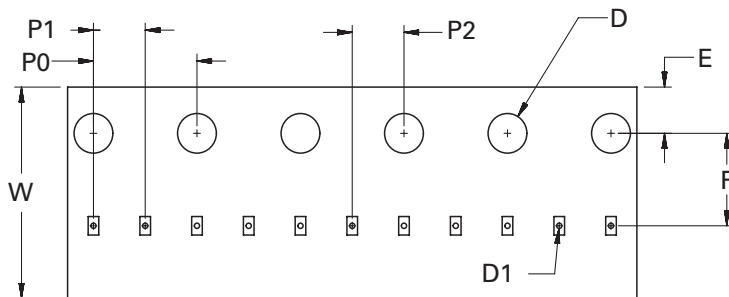

Symbol	Millimeters
A0	0.41+/-0.03
B0	0.70+/-0.03
D	∅ 1.50 + 0.10
D1	∅ 0.20 +/- 0.05
E	1.75+/-0.10
F	3.50+/-0.05
K0	0.38+/-0.03
P0	4.00+/-0.10
P1	2.00+/-0.05
P2	2.00+/-0.05
W	8.00+0.30/-0.10
T	0.23+/-0.02

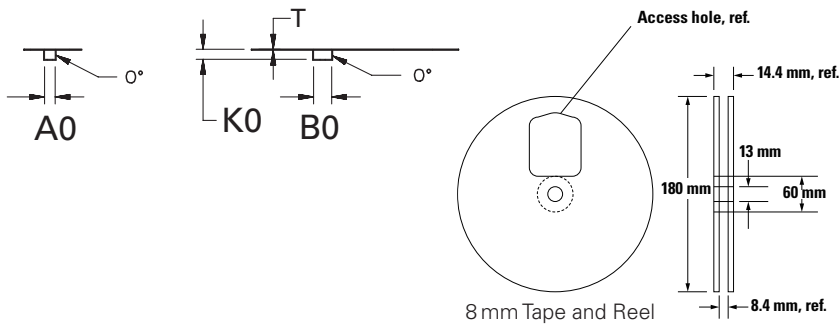

Component Orientation in Tape

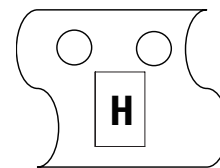

Product Disclaimer: Littelfuse products are not designed for, and shall not be used for, any purpose (including, without limitation, automotive, military, aerospace, medical, life-saving, life-sustaining or nuclear facility applications, devices intended for surgical implant into the body, or any other application in which the failure or lack of desired operation of the product may result in personal injury, death, or property damage) other than those expressly set forth in applicable Littelfuse product documentation. Warranties granted by Littelfuse shall be deemed void for products used for any purpose not expressly set forth in applicable Littelfuse documentation. Littelfuse shall not be liable for any claims or damages arising out of products used in applications not expressly intended by Littelfuse as set forth in applicable Littelfuse documentation. The sale and use of Littelfuse products is subject to Littelfuse Terms and Conditions of Sale, unless otherwise agreed by Littelfuse. "Littelfuse" includes Littelfuse, Inc., and all of its affiliate entities. <http://www.littelfuse.com/disclaimer-electronics>.