

# SP3384NUTG Series

## Lightning Surge Protection

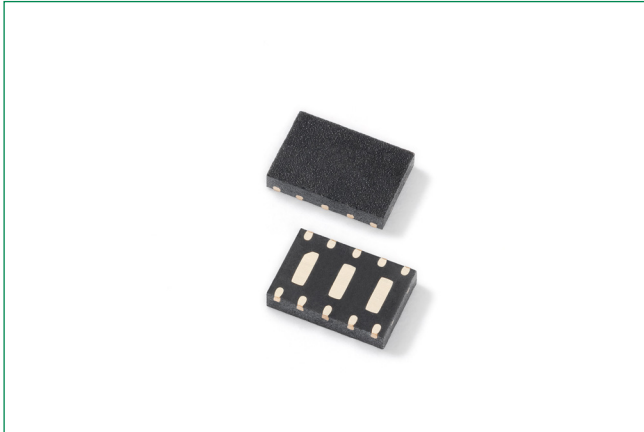

### Pinout

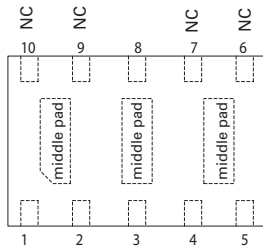

Note: PIN3, PIN8 and middle PADS are same potential

Top View

### Functional Block Diagram

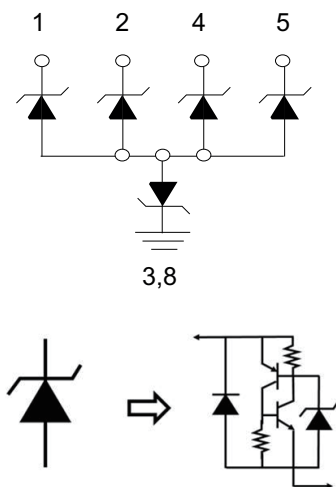

### Description

The SP3384NUTG is a low-capacitance, TVS Diode Array designed to provide protection against ESD (electrostatic discharge), CDE (cable discharge events), EFT (electrical fast transients), and lightning induced surges for highspeed, differential data lines. It's packaged in a  $\mu$ DFN package (3.0 x 2.0mm) and each device can protect up 4 channels up to 15A (IEC 61000-4- 5 2nd edition,) and up to  $\pm 30$ kV ESD (IEC 61000-4-2).

The SP3384NUTG with its low capacitance and low clamping voltage makes it ideal for high-speed data interfaces up to 10GbE application found in switches, servers, etc.

### Features

- ESD, IEC 61000-4-2,  $\pm 30$ kV contact,  $\pm 30$ kV air
- EFT, IEC 61000-4-4, 40A (5/50ns)
- Lightning, IEC 61000- 4-5 2nd edition, 15A (tP=8/20 $\mu$ s)
- Low capacitance of 0.5pF@0V (TYP)
- Low leakage current of 3nA(typ) & 40nA(max) at 3.3V
- Low leakage current of 40nA at 3.3V in 100°C"
- Low operating and clamping voltage
- $\mu$ DFN-10 package is optimized for high-speed data line routing
- Provides protection for two differential data pairs (4 channels) up to 15A
- AEC-Q101 qualified
- Halogen free, Lead free and RoHS compliant
- Moisture Sensitivity Level (MSL -1)

### Applications

- WAN/LAN Equipment
- Desktops, Servers and Notebooks
- LVDS Interfaces
- Integrated Magnetics
- Smart TV
- 2.5G/5G/10G Ethernet

### Application Example

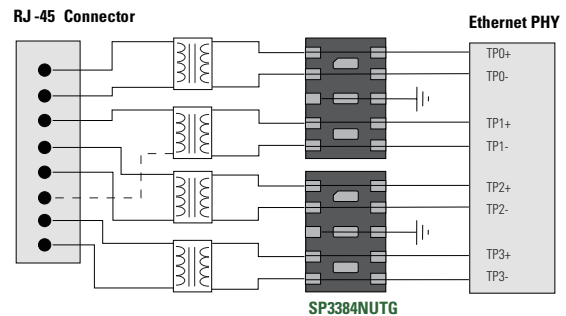

Life Support Note:

#### Not Intended for Use in Life Support or Life Saving Applications

The products shown herein are not designed for use in life sustaining or life saving applications unless otherwise expressly indicated.



# SP3384NUTG Series

## Lightning Surge Protection

### Absolute Maximum Ratings

Symbol	Parameter	Value	Units
$I_{PP}$	Peak Current ( $t_p=8/20\mu s$ )	15	A
$T_{OP}$	Operating Temperature	-40 to 125	°C
$T_{STOR}$	Storage Temperature	-55 to 150	°C

**CAUTION:** Stresses above those listed in "Absolute Maximum Ratings" may cause permanent damage to the component. This is a stress only rating and operation of the component at these or any other conditions above those indicated in the operational sections of this specification is not implied.

### Electrical Characteristics ( $T_{OP}=25^\circ C$ )

Parameter	Symbol	Test Conditions	Min	Typ	Max	Units
Reverse Standoff Voltage	$V_{RWM}$	$I_R = 1\mu A$			3.3	V
Breakdown Voltage	$V_{BR}$	$I_R = 1mA$	6.5	9		V
Reverse Leakage Current	$I_{LEAK}$	$V_R=3.3V$		3	20	nA
		$V_R=3.3V$ at 100°C		40		nA
Holding Voltage	$V_{HOLD}$	I/O to I/O		2.3		V
Clamp Voltage <sup>1</sup>	$V_C$	$I_{PP}=1A, t_p=8/20\mu s$		4	5.5	V
		$I_{PP}=15A, t_p=8/20\mu s$		12	15	V
Dynamic Resistance <sup>2</sup>	$R_{DYN}$	TLP, $t_p=100ns$		0.34		$\Omega$
ESD Withstand Voltage <sup>1,3</sup>	$V_{ESD}$	IEC 61000-4-2 (Contact Discharge)	$\pm 30$			kV
		IEC 61000-4-2 (Air Discharge)	$\pm 30$			kV
Diode Capacitance <sup>1</sup>	$C_{I/O-I/O}$	Reverse Bias=0V, f=1MHz		0.5	0.7	pF

#### Notes:

- Parameter is guaranteed by design and/or component characterization.
- Transmission Line Pulse (TLP) test setting : Std.TDR(50 $\Omega$ ), $t_p=100ns$ ,  $t_r=0.2ns$  ITLP and VTLP averaging window: start  $t_1=70ns$  to end  $t_2=90ns$
- Device stressed with ten non-repetitive ESD pulses.

#### 8/20 $\mu s$ Pulse Waveform

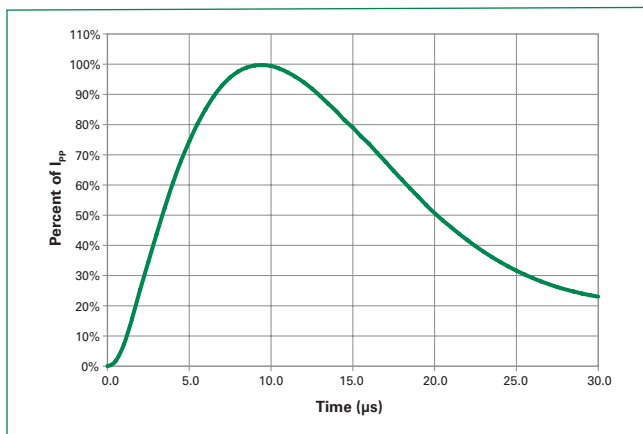

#### Capacitance vs. Reverse Bias

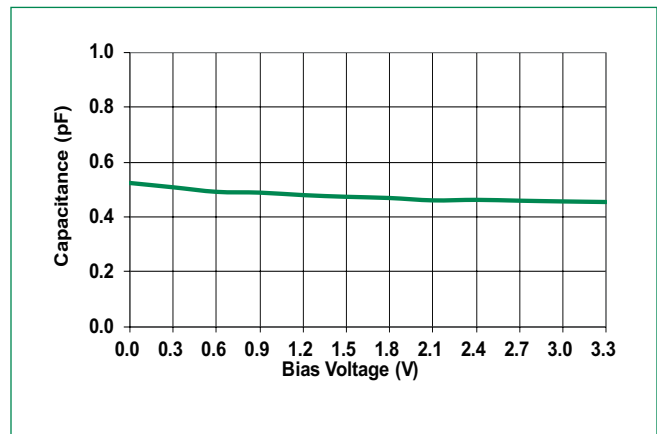

# SP3384NUTG Series

## Lightning Surge Protection

Positive Transmission Line Pulsing (TLP) Plot

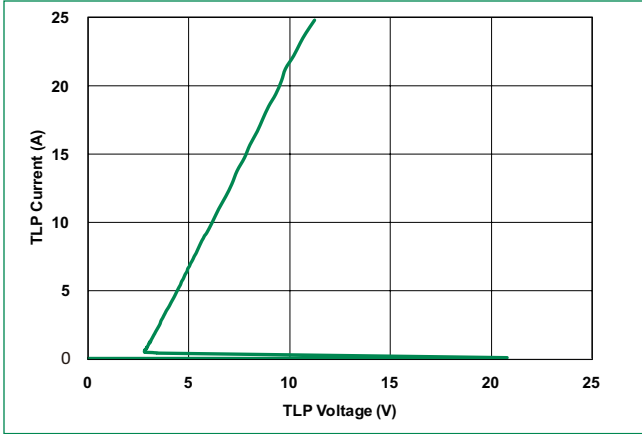

Negative Transmission Line Pulsing (TLP) Plot

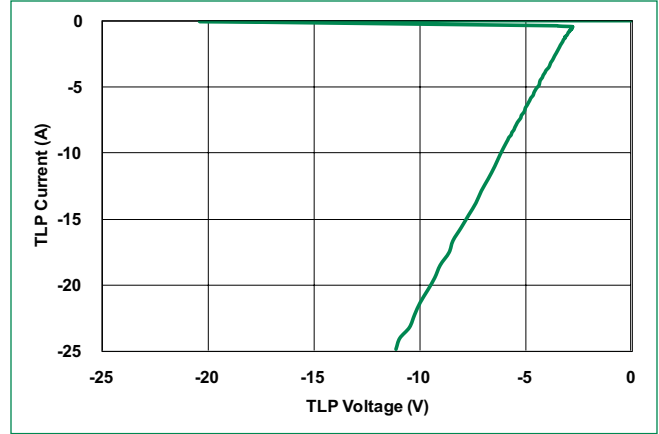

Clamping Voltage vs. Peak Pulse Current

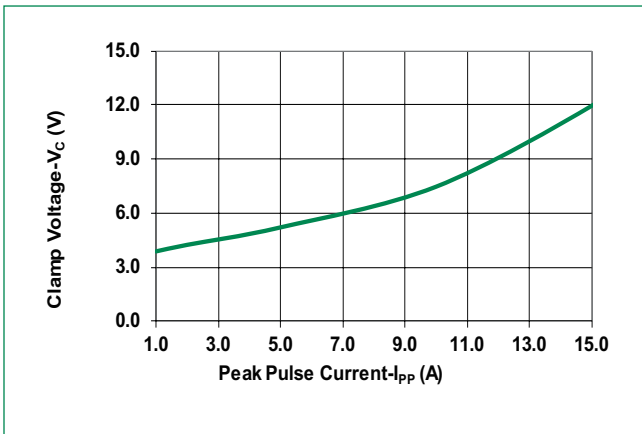

IEC 61000-4-2 +8 kV Contact ESD Clamping Voltage

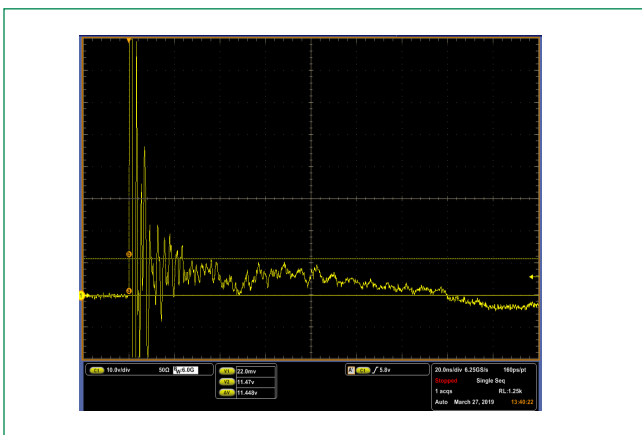

IEC 61000-4-2 -8 kV Contact ESD Clamping Voltage

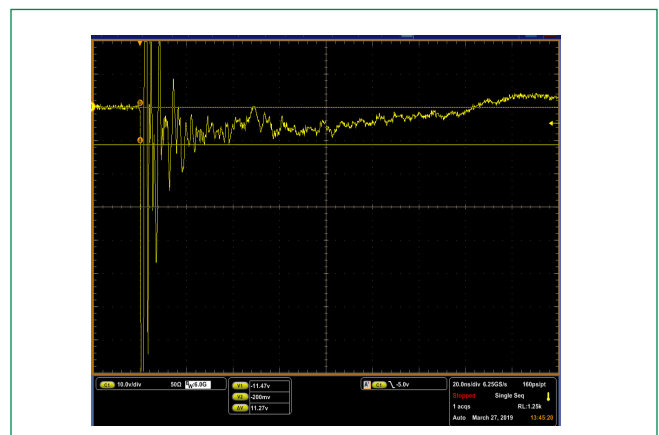

# SP3384NUTG Series

## Lightning Surge Protection

### Soldering Parameters

<b>Reflow Condition</b>		Pb – Free assembly
<b>Pre Heat</b>	- Temperature Min ( $T_{s(min)}$ )	150°C
	- Temperature Max ( $T_{s(max)}$ )	200°C
	- Time (min to max) ( $t_s$ )	60 – 120 secs
<b>Average ramp up rate (Liquidus) Temp (<math>T_L</math>) to peak</b>		3°C/second max
<b><math>T_{s(max)}</math> to <math>T_L</math> - Ramp-up Rate</b>		3°C/second max
<b>Reflow</b>	- Temperature ( $T_L$ ) (Liquidus)	217°C
	- Temperature ( $t_L$ )	60 – 150 seconds
<b>Peak Temperature (<math>T_p</math>)</b>		260 <sup>+0/-5</sup> °C
<b>Time within 5°C of actual peak Temperature (<math>t_p</math>)</b>		30 seconds
<b>Ramp-down Rate</b>		6°C/second max
<b>Time 25°C to peak Temperature (<math>T_p</math>)</b>		8 minutes Max.
<b>Do not exceed</b>		260°C

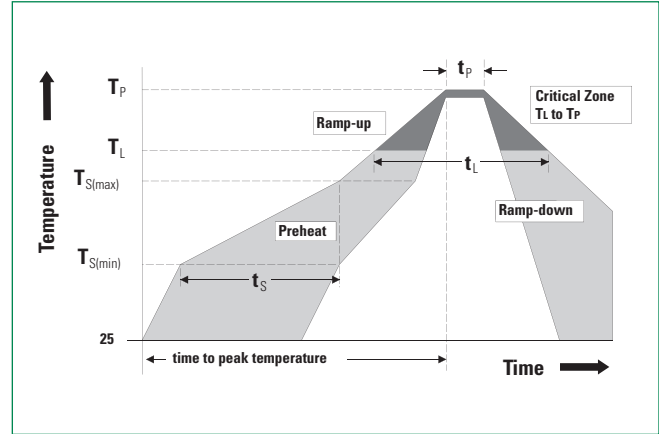

### Ordering Information

Part Number	Package	Min. Order Qty.
SP3384NUTG	μDFN-10 (3.0x2.0mm)	3000

### Product Characteristics

<b>Lead Plating</b>	PPF
<b>Lead Material</b>	Copper Alloy
<b>Substrate Material</b>	Silicon
<b>Body Material</b>	Molded Compound
<b>Flammability</b>	UL Recognized compound meeting flammability rating V-0

### Part Marking System

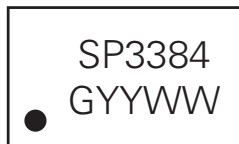

First row = Part name = SP3384  
Second row = Assembly code + Date Code

### Part Numbering System

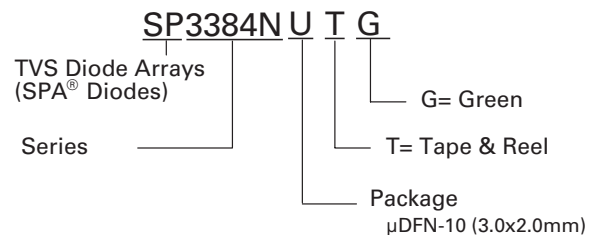

# SP3384NUTG Series

## Lightning Surge Protection

### Package Dimensions - $\mu$ DFN-10 (3.0x2.0mm)

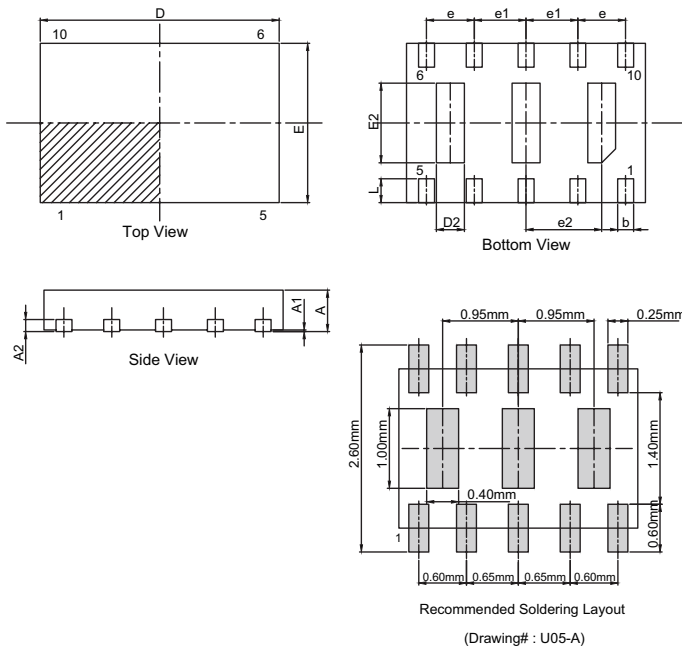

Symbol	Millimeters			Inches		
	Min	Nom	Max	Min	Nom	Max
A	0.50	0.55	0.60	0.020	0.022	0.024
A1	0.00	0.02	0.05	0.000	0.001	0.002
A2	0.15 Ref			0.006 Ref		
b	0.15	0.20	0.25	0.006	0.008	0.010
D	2.90	3.00	3.10	0.114	0.118	0.122
E	1.90	2.00	2.10	0.075	0.079	0.083
D2	0.25	0.35	0.45	0.010	0.014	0.018
E2	0.90	1.00	1.10	0.035	0.039	0.043
L	0.20	0.30	0.40	0.008	0.012	0.016
e	0.60 BSC			0.024 BSC		
e1	0.65 BSC			0.026 BSC		
e2	0.95 BSC			0.037 BSC		

### Tape & Reel Specification – $\mu$ DFN-10 (3.0x2.0mm)

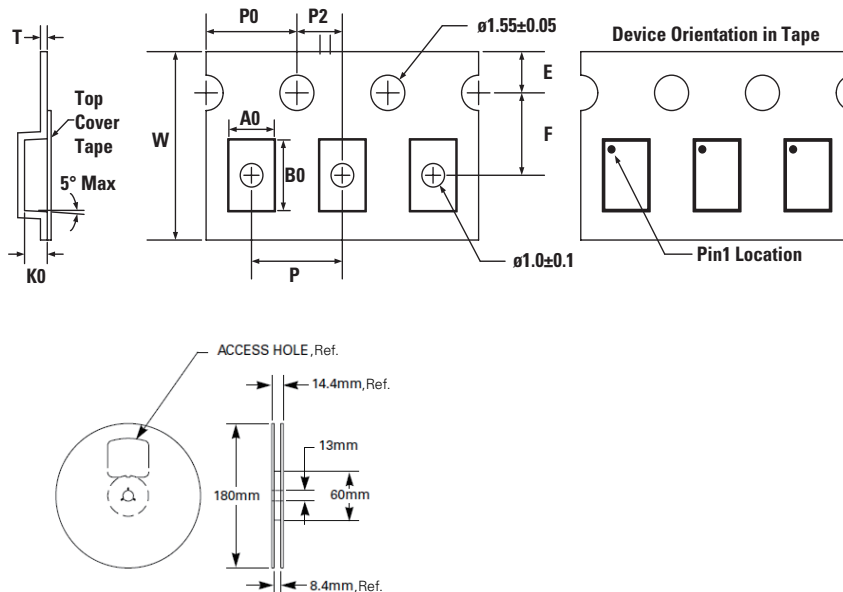

Package	$\mu$ DFN-10 (3.0x2.0mm)
Symbol	Millimeters
A0	2.30 +/- 0.10
B0	3.20 +/- 0.10
E	1.75 +/- 0.10
F	3.50 +/- 0.05
K0	1.0 +/- 0.10
P	4.00 +/- 0.10
P0	4.00 +/- 0.10
P2	2.00 +/- 0.10
T	0.3 +/- 0.05
W	8.00 +0.30/- 0.10

**Disclaimer Notice** - Information furnished is believed to be accurate and reliable. However, users should independently evaluate the suitability of and test each product selected for their own applications. Littelfuse products are not designed for, and may not be used in, all applications. Read complete Disclaimer Notice at <http://www.littelfuse.com/disclaimer-electronics>.