

SP4045 Series

Lightning Surge Protection

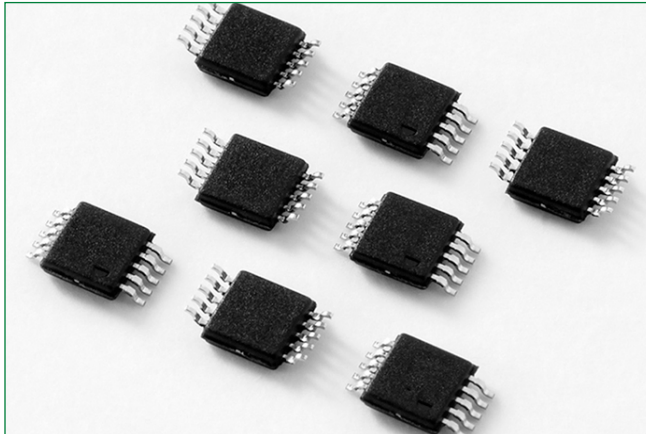

Description

The SP4045 integrates low capacitance diodes with an additional zener diode to protect each I/O pin against ESD and high surge events. This robust device can safely absorb up to 24A per IEC 61000-4-5 2nd edition ($t_p=8/20\mu s$) without performance degradation and a minimum $\pm 30kV$ ESD per IEC 61000-4-2 International Standard. Their low loading capacitance also makes them ideal for protecting high speed signal pins.

Features

- Signal-integrity-preserving straight through routing
- Low leakage current of $1\mu A$ (MAX) at 3.3V
- ESD, IEC 61000-4-2, $\pm 30kV$ contact, $\pm 30kV$ air
- EFT, IEC 61000-4-4, 40A (5/50ns)
- Lightning, IEC 61000-4-5 2nd edition, 24A (8/20 μs)
- Low capacitance of 1.5pF (TYP) per I/O
- AEC-Q101 qualified
- Halogen free, Lead free and RoHS compliant
- Moisture Sensitivity Level (MSL Level-1)

Additional Information



Resources



Accessories



Samples

Pinout

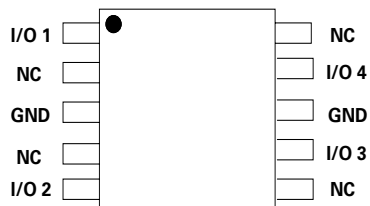

Applications

- HDBaseT Protector
- 10/100/1000 Ethernet
- 2.5 and 5 Gigabit Ethernet
- T1/E1 Secondary Protection
- T3/E3 Secondary Protection
- A/V Equipment
- Automotive Ethernet

Functional Block Diagram

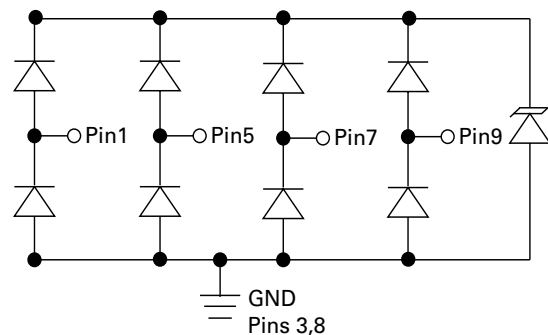

Life Support Note:

Not Intended for Use in Life Support or Life Saving Applications

The products shown herein are not designed for use in life sustaining or life saving applications unless otherwise expressly indicated.

SP4045 Series

Lightning Surge Protection

Absolute Maximum Ratings

| Symbol | Parameter | Value | Units |
|------------|--------------------------------------|------------|-------|
| I_{PP} | Peak Current ($t_p=8/20\mu s$) | 24 | A |
| P_{PK} | Peak Pulse Power ($t_p=8/20\mu s$) | 600 | W |
| T_{OP} | Operating Temperature | -40 to 125 | °C |
| T_{STOR} | Storage Temperature | -55 to 150 | °C |

Caution: Stresses above those listed in "Absolute Maximum Ratings" may cause permanent damage to the device. This is a stress only rating and operation of the device at these or any other conditions above those indicated in the operational sections of this specification is not implied.

Thermal Information

| Parameter | Rating | Units |
|---|------------|-------|
| Storage Temperature Range | -55 to 150 | °C |
| Maximum Junction Temperature | 150 | °C |
| Maximum Lead Temperature (Soldering 20-40s) | 260 | °C |

Electrical Characteristics ($T_{OP}=25^\circ C$)

| Parameter | Symbol | Test Conditions | Min | Typ | Max | Units |
|------------------------------------|---------------|-------------------------------------|----------|-----|-----|----------|
| Reverse Standoff Voltage | V_{RWM} | | | | 3.3 | V |
| Snap Back Voltage | V_{SB} | $I_{SB}=50mA$ | 2.8 | | | V |
| Reverse Leakage Current | I_{LEAK} | $V_R=3.3V$, I/O to GND | | 0.5 | 1.0 | μA |
| Clamp Voltage ¹ | V_C | $I_{PP}=1A$, $t_p=8/20\mu s$, Fwd | | 6.0 | | V |
| | | $I_{PP}=2A$, $t_p=8/20\mu s$, Fwd | | 7.0 | | V |
| Dynamic Resistance ² | R_{DYN} | TLP $t_p=100ns$, Pin 1 to Pin 2 | | 0.3 | | Ω |
| ESD Withstand Voltage ¹ | V_{ESD} | IEC 61000-4-2 (Contact) | ± 30 | | | kV |
| | | IEC 61000-4-2 (Air) | ± 30 | | | kV |
| Diode Capacitance ¹ | $C_{I/O-GND}$ | Reverse Bias=0V | | 1.5 | | pF |

Note: 1. Parameter is guaranteed by design and/or device characterization.

2. Transmission Line Pulse (TLP) test setting : Std.TDR(50 Ω), $t_p=100ns$, $t_r=0.2ns$ ITLP and VTLP averaging window: star $t_1=70ns$ to end $t_2=80ns$

8/20 μs Pulse Waveform

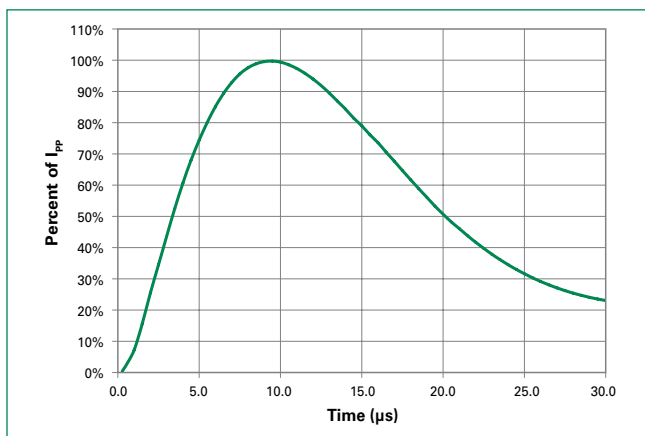

Capacitance vs. Reverse Bias

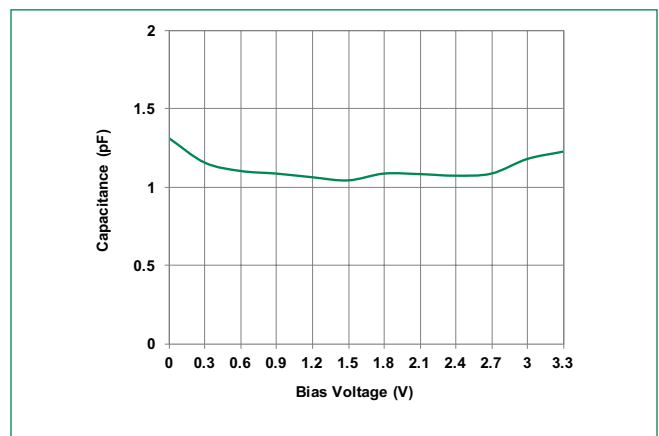

SP4045 Series

Lightning Surge Protection

Clamping Voltage vs. IPP

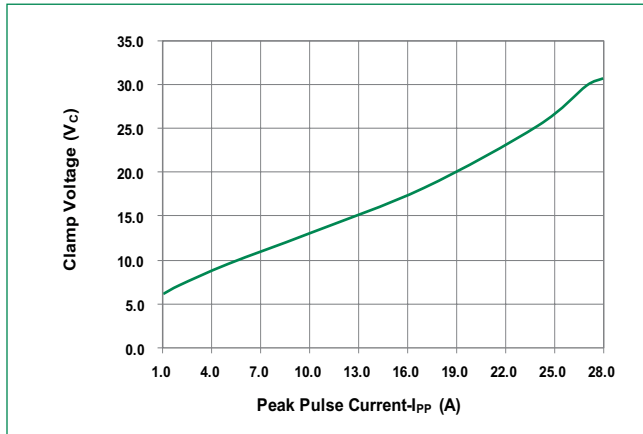

Transmission Line Pulsing (TLP) Plot (Pin 1 to Pin2)

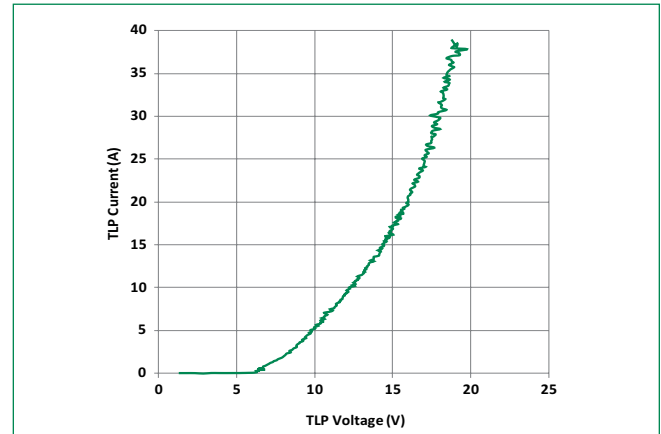

Soldering Parameters

| | | |
|--|------------------------------------|------------------|
| Reflow Condition | Pb – Free assembly | |
| Pre Heat | - Temperature Min ($T_{s(min)}$) | 150°C |
| | - Temperature Max ($T_{s(max)}$) | 200°C |
| | - Time (min to max) (t_s) | 60 – 120 secs |
| Average ramp up rate (Liquidus) Temp (T_L) to peak | 3°C/second max | |
| $T_{s(max)}$ to T_L - Ramp-up Rate | 3°C/second max | |
| Reflow | - Temperature (T_L) (Liquidus) | 217°C |
| | - Temperature (t_L) | 60 – 150 seconds |
| Peak Temperature (T_p) | 260 ^{+0/-5} °C | |
| Time within 5°C of actual peak Temperature (t_p) | 30 seconds | |
| Ramp-down Rate | 6°C/second max | |
| Time 25°C to peak Temperature (T_p) | 8 minutes Max. | |
| Do not exceed | 260°C | |

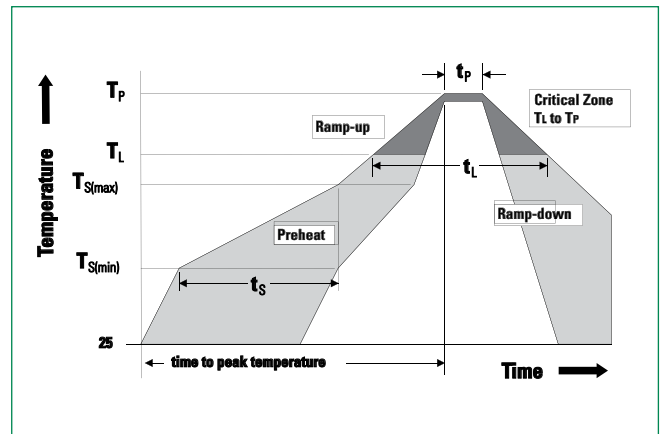

Part Numbering System

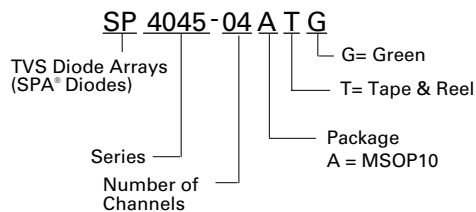

Ordering Information

| Part Number | Package | Marking | Min. Order Qty. |
|--------------|---------|---------|-----------------|
| SP4045-04ATG | MSOP-10 | ⒺH4 | 4000 |

Product Characteristics

| | |
|---------------------------|----------------------------|
| Lead Plating | Pre-Plated Frame |
| Lead Material | Copper Alloy |
| Lead Coplanarity | 0.0004 inches (0.102mm) |
| Substrate material | Silicon |
| Body Material | V-0 per UL 94 Molded Epoxy |

Notes :

- All dimensions are in millimeters
- Dimensions include solder plating.
- Dimensions are exclusive of mold flash & metal burr.
- Blo is facing up for mold and facing down for trim/form, i.e. reverse trim/form.
- Package surface matte finish VDI 11-13.

Part Marking System

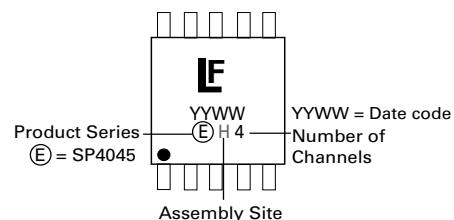

SP4045 Series

Lightning Surge Protection

Package Dimensions – MSOP-10

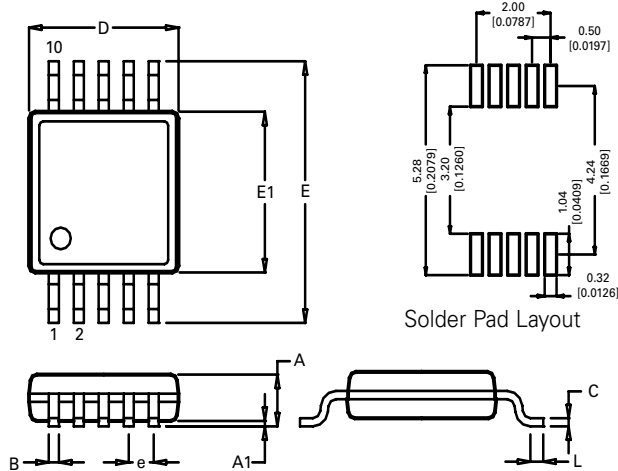

| Package | MSOP | | | |
|---------|-------------|------|-----------|-------|
| Pins | 10 | | | |
| JEDEC | MO-187 | | | |
| | Millimeters | | Inches | |
| DIM | Min | Max | Min | Max |
| A | - | 1.10 | - | 0.043 |
| A1 | 0.00 | 0.15 | 0.000 | 0.006 |
| B | 0.17 | 0.27 | 0.007 | 0.011 |
| c | 0.08 | 0.23 | 0.003 | 0.009 |
| D | 2.90 | 3.10 | 0.114 | 0.122 |
| E | 4.67 | 5.10 | 0.184 | 0.200 |
| E1 | 2.90 | 3.10 | 0.114 | 0.122 |
| e | 0.50 BSC | | 0.020 BSC | |
| L | 0.40 | 0.80 | 0.016 | 0.032 |

Embossed Carrier Tape & Reel Specification – MSOP-10

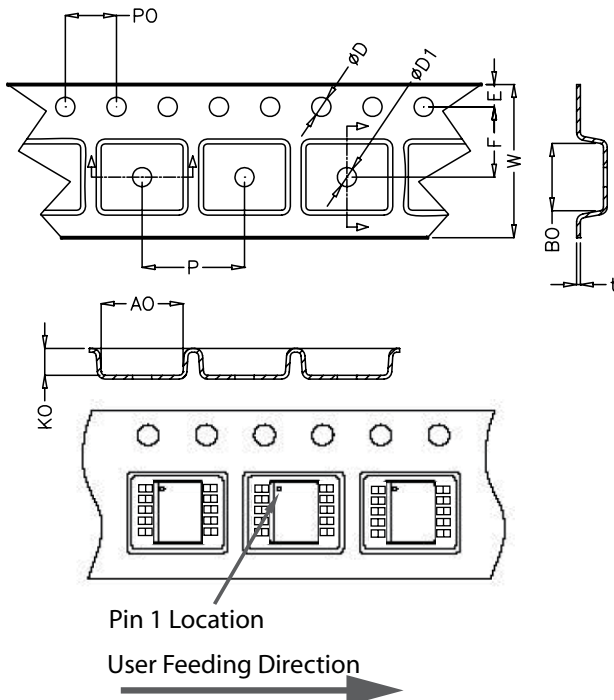

| | Millimeters | | Inches | |
|----|---------------|-------|-----------------|-------|
| | Min | Max | Min | Max |
| E | 1.65 | 1.85 | 0.065 | 0.073 |
| F | 5.40 | 5.60 | 0.213 | 0.220 |
| D | 1.50 | 1.60 | 0.059 | 0.063 |
| D1 | 1.50 Min | | 0.059 Min | |
| P0 | 3.90 | 4.10 | 0.154 | 0.161 |
| W | 11.70 | 12.30 | 0.460 | 0.484 |
| P | 7.90 | 8.10 | 0.311 | 0.319 |
| A0 | 5.20 | 5.40 | 0.205 | 0.213 |
| B0 | 3.20 | 3.50 | 0.126 | 0.138 |
| K0 | 1.20 | 1.50 | 0.047 | 0.059 |
| t | 0.30 +/- 0.05 | | 0.012 +/- 0.002 | |

Disclaimer Notice - Information furnished is believed to be accurate and reliable. However, users should independently evaluate the suitability of and test each product selected for their own applications. Littelfuse products are not designed for, and may not be used in, all applications. Read complete Disclaimer Notice at www.littelfuse.com/disclaimer-electronics.