

SP4050 Series

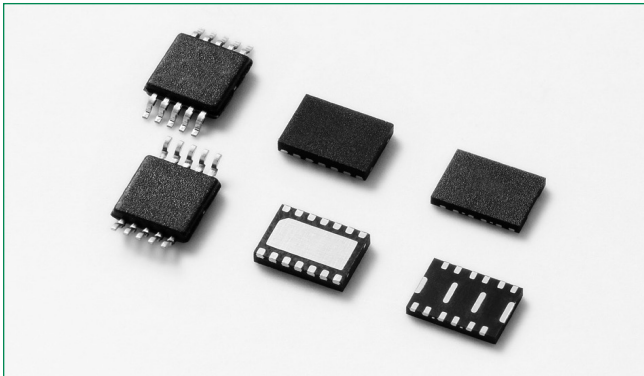

OBSOLETE DATE: 06/10th/2020 PCN/ECN# ESU270-51
REPLACED BY: SP4060-08ATG



Pinout

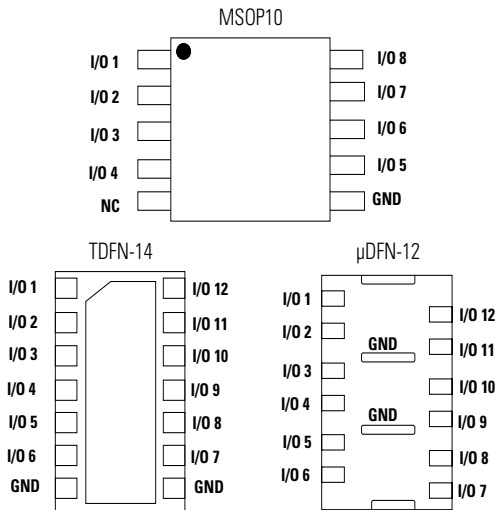

Note: Pinout diagrams above shown as component footprint on circuit board.

Functional Block Diagram

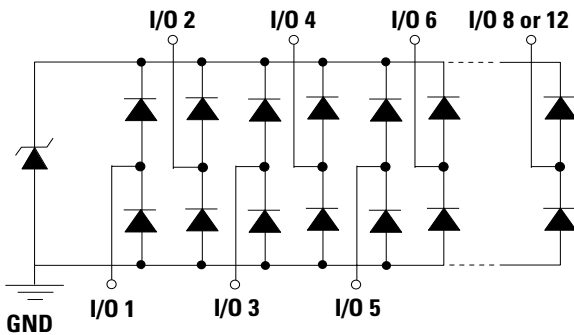

Life Support Note:

Not Intended for Use in Life Support or Life Saving Applications

The products shown herein are not designed for use in life sustaining or life saving applications unless otherwise expressly indicated.

Description

The SP4050 integrates low capacitance diodes with an additional zener diode to protect each I/O pin against ESD and high surge events. This robust component can safely absorb up to 20A per IEC 61000-4-5 2nd edition ($t_p=8/20\mu s$) without performance degradation and a minimum $\pm 30kV$ ESD per IEC 61000-4-2 International Standard. Their low loading capacitance also makes them ideal for protecting high speed signal pins.

Features

- ESD, IEC 61000-4-2, $\pm 30kV$ contact, $\pm 30kV$ air
- EFT, IEC 61000-4-4, 40A (5/50ns)
- Lightning, IEC 61000-4-5 2nd edition, 20A ($t_p=8/20\mu s$)
- Low capacitance of 4.4pF (TYP) per I/O
- Low leakage current of 0.5 μA (MAX) at 2.5V
- Moisture Sensitivity Level (MSL -1)
- Halogen free, lead free and RoHS compliant

Applications

- LCD/PDP TVs
- Desktops
- Game Consoles
- Set Top Boxes
- Notebooks

Application Example

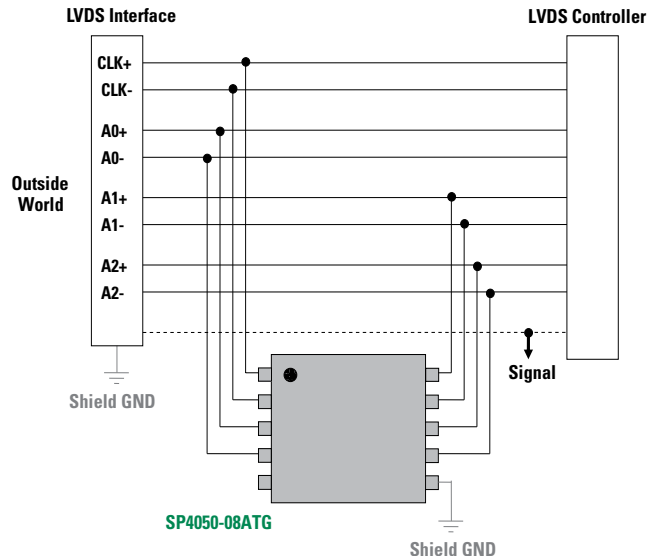

Absolute Maximum Ratings

Symbol	Parameter	Value	Units
I_{PP}	Peak Current ($t_p=8/20\mu s$)	20.0	A
P_{PK}	Peak Pulse Power ($t_p=8/20\mu s$)	300	W
T_{OP}	Operating Temperature	-40 to 125	°C
T_{STOR}	Storage Temperature	-55 to 150	°C

CAUTION: Stresses above those listed in "Absolute Maximum Ratings" may cause permanent damage to the component. This is a stress only rating and operation of the component at these or any other conditions above those indicated in the operational sections of this specification is not implied.

Electrical Characteristics ($T_{OP}=25^\circ C$)

Parameter	Symbol	Test Conditions	Min	Typ	Max	Units
Reverse Standoff Voltage	V_{RWM}				2.5	V
Snap Back Voltage	V_{SB}	$I_{SB}=50mA$	2.0			V
Reverse Leakage Current	I_{LEAK}	$V_R=2.5V$, I/O to GND			0.5	μA
Clamp Voltage ¹	V_C	$I_{PP}=1A$, $t_p=8/20\mu s$, Fwd		4.5		V
		$I_{PP}=10A$, $t_p=8/20\mu s$, Fwd		8.9		V
		$I_{PP}=20A$, $t_p=8/20\mu s$, Fwd		13.2		V
ESD Withstand Voltage ¹	V_{ESD}	IEC 61000-4-2 (Contact)	± 30			kV
		IEC 61000-4-2 (Air)	± 30			kV
Diode Capacitance ¹	$C_{I/O-GND}$	Reverse Bias=0V		4.4		pF
Diode Capacitance ¹	$C_{I/O-I/O}$	Reverse Bias=0V		2.2		pF

Note: ¹ Parameter is guaranteed by design and/or component characterization.

8/20 μs Pulse Waveform

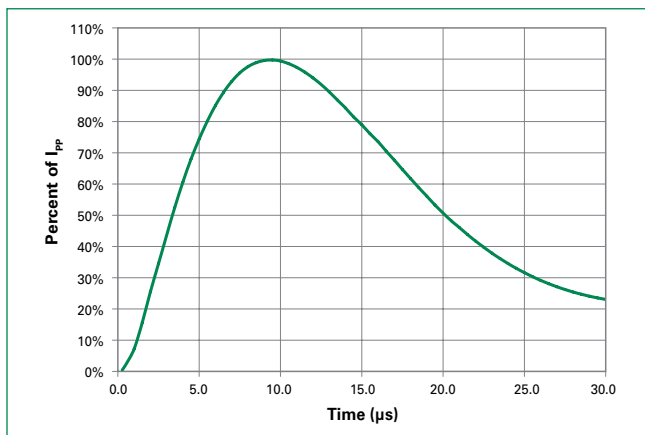

Clamping Voltage vs. I_{PP}

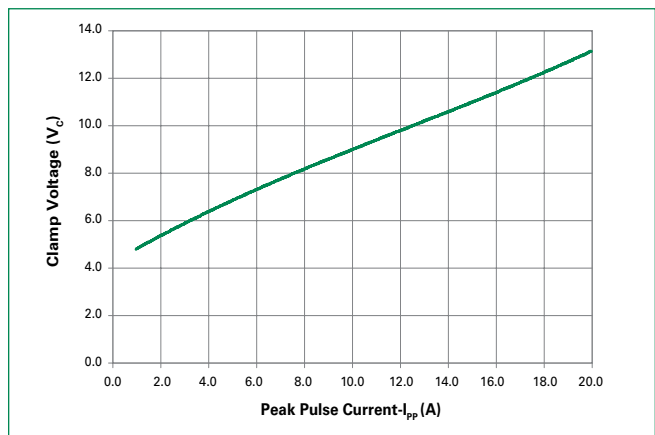

Capacitance vs. Bias

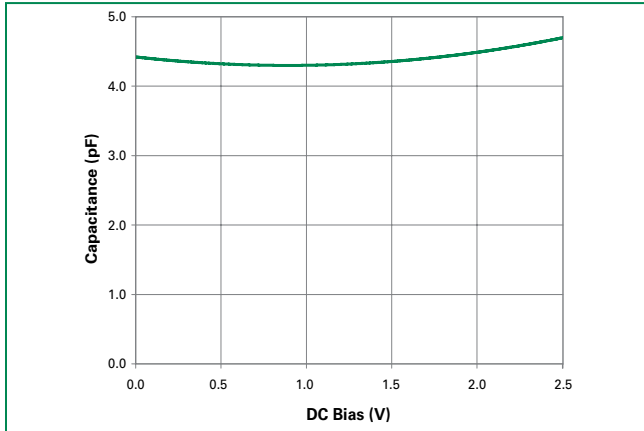

Insertion Loss (S21) I/O to GND

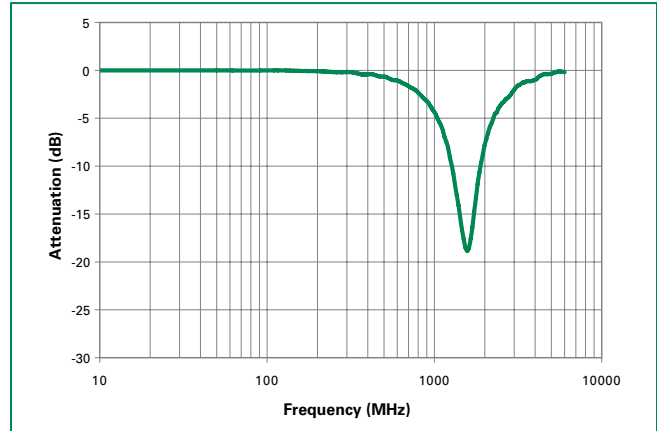

Soldering Parameters

Reflow Condition	Pb – Free assembly	
Pre Heat	- Temperature Min ($T_{s(min)}$)	150°C
	- Temperature Max ($T_{s(max)}$)	200°C
	- Time (min to max) (t_s)	60 – 180 secs
Average ramp up rate (Liquidus) Temp (T_L) to peak	3°C/second max	
$T_{s(max)}$ to T_L - Ramp-up Rate	3°C/second max	
Reflow	- Temperature (T_L) (Liquidus)	217°C
	- Temperature (t_L)	60 – 150 seconds
Peak Temperature (T_p)	250 ^{+0/-5} °C	
Time within 5°C of actual peak Temperature (t_p)	20 – 40 seconds	
Ramp-down Rate	6°C/second max	
Time 25°C to peak Temperature (T_p)	8 minutes Max.	
Do not exceed	260°C	

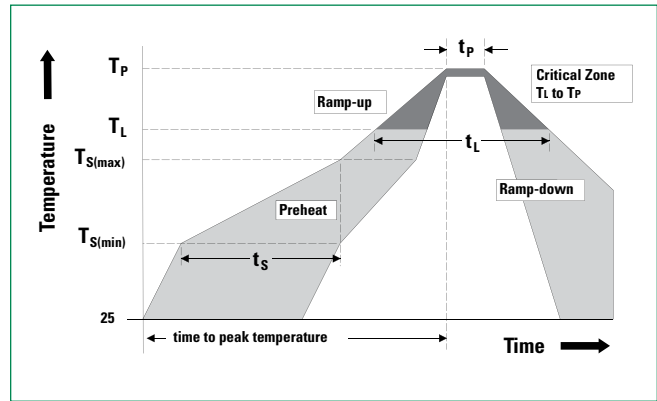

Ordering Information

Part Number	Package	Marking	Min. Order Qty.
SP4050-08ATG	MSOP10	P*8	4000
SP4050-12TTG	TDFN-14	P*12	3000
SP4050-12UTG	µDFN-12	P*12	3000

Part Marking System

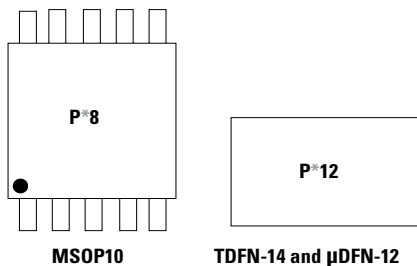

Note: * Assembly Site

Part Numbering System

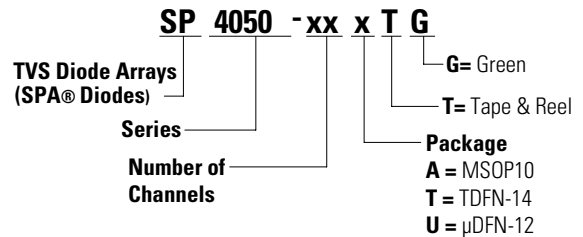

Package Dimensions - MSOP10

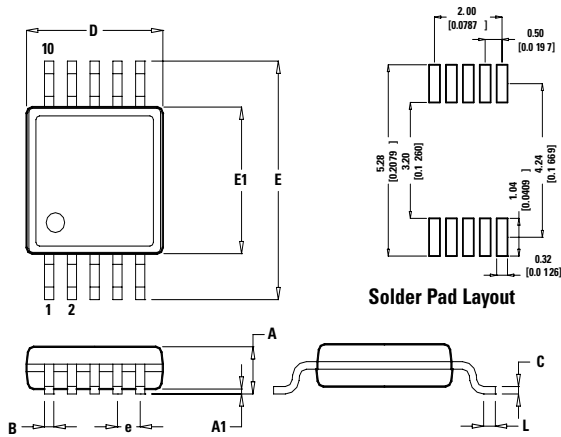

Package	MSOP10			
Pins	10			
Units	Millimeters		Inches	
DIM	Min	Max	Min	Max
A	-	1.10	-	0.043
A1	0.00	0.15	0.000	0.006
B	0.17	0.27	0.007	0.011
c	0.08	0.23	0.003	0.009
D	2.90	3.10	0.114	0.122
E	4.67	5.10	0.184	0.200
E1	2.90	3.10	0.114	0.122
e	0.50 BSC		0.020 BSC	
L	0.40	0.80	0.016	0.032

Package Dimensions - TDFN-14

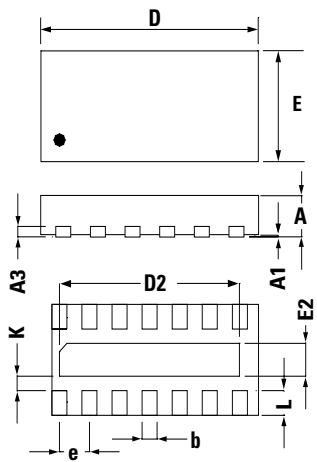

Symbol	TDFN-14			
	Millimeters		Inches	
	Min	Max	Min	Max
A	0.70	0.80	0.028	0.032
A1	0.00	0.05	0.00	0.002
A3	0.203 REF		0.008 REF	
b	0.20	0.30	0.008	0.012
D	3.40	3.60	0.134	0.142
D2	2.95	3.05	0.117	0.121
E	2.40	2.60	0.095	0.103
E2	1.40	1.50	0.056	0.060
e	0.50 BSC		0.02 BSC	
K	0.20	0.25	0.0075	0.095
L	0.25	0.35	0.01	0.014

Package Dimensions - μ DFN-12

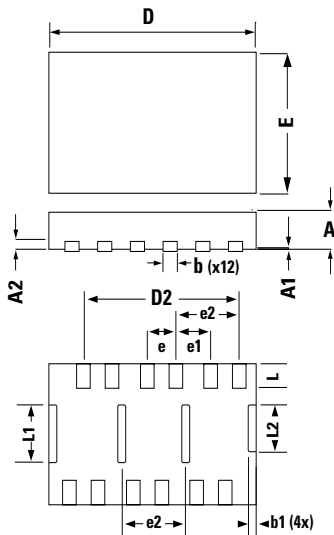

Symbol	μ DFN-12			
	Millimeters		Inches	
	Min	Max	Min	Max
A	0.50	0.65	0.020	0.026
A1	0.00	0.05	0.00	0.002
A2	0.150 REF		0.006 REF	
b	0.15	0.25	0.006	0.010
b1	0.10	0.30	0.004	0.012
D	3.40	3.60	0.134	0.142
D2	2.70		0.106	
E	2.40	2.60	0.095	0.103
e	0.50 BSC		0.020 BSC	
e1	0.60 BSC		0.024 BSC	
e2	1.10 BSC		0.044 BSC	
L	0.30	0.40	0.012	0.016
L1	0.90	1.10	0.036	0.044
L2	0.70	0.90	0.028	0.036

Embossed Carrier Tape & Reel Specification - MSOP10

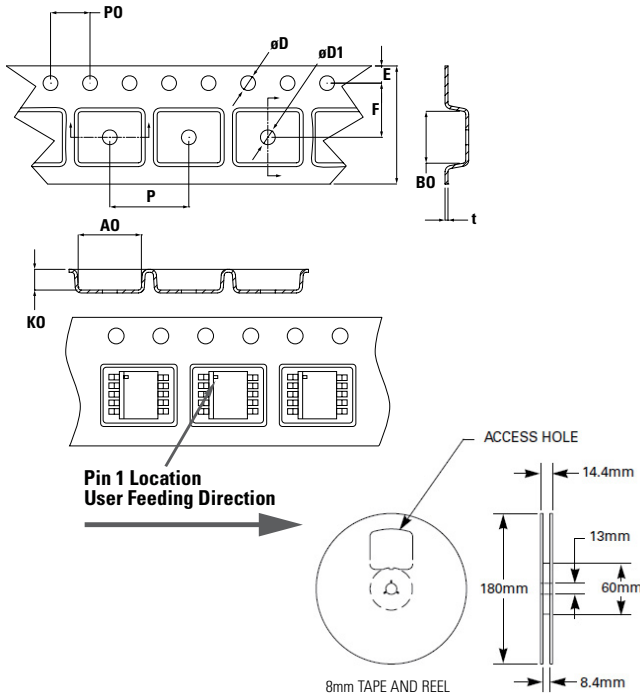

Symbol	Millimeters		Inches	
	Min	Max	Min	Max
A0	5.20	5.40	0.205	0.213
B0	3.20	3.40	0.126	0.134
D	1.50	1.60	0.059	0.063
D1	1.50 Min		0.059 Min	
E	1.65	1.85	0.065	0.073
F	5.40	5.60	0.213	0.220
P0	3.90	4.10	0.154	0.161
10P0	40.0+/- 0.20		1.574+/-0.008	
W	11.90	12.10	0.469	0.476
P	7.90	8.10	0.311	0.319
K0	1.20	1.40	0.047	0.055
t	0.30 +/- 0.05		0.012+/- 0.002	

Embossed Carrier Tape & Reel Specification – TDFN-14 and μ DFN-12

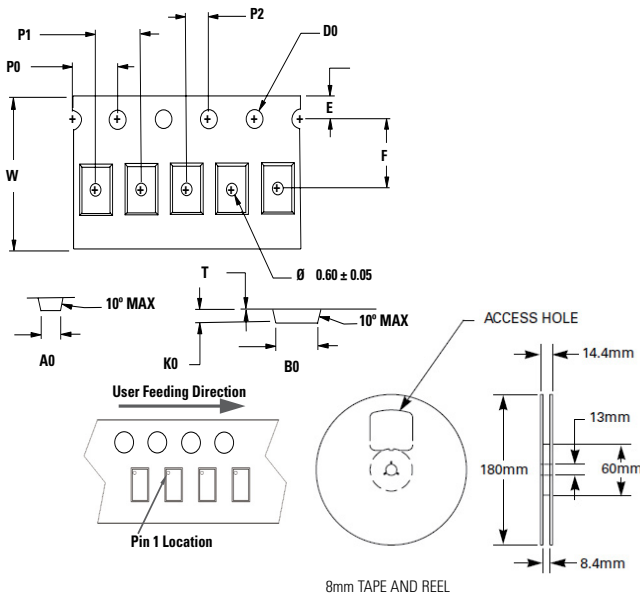

Symbol	Millimeters		Inches	
	Min	Max	Min	Max
A0	2.63	2.83	0.104	0.112
B0	3.63	3.83	0.143	0.151
D0	1.40	1.60	0.055	0.063
E	1.65	1.85	0.065	0.073
F	5.45	5.55	0.215	0.219
K0	0.85	1.05	0.033	0.041
P0	3.90	4.10	0.154	0.161
P1	3.90	4.10	0.154	0.161
P2	1.95	2.05	0.077	0.081
T	0.18	0.22	0.007	0.009
W	11.90	12.30	0.469	0.484