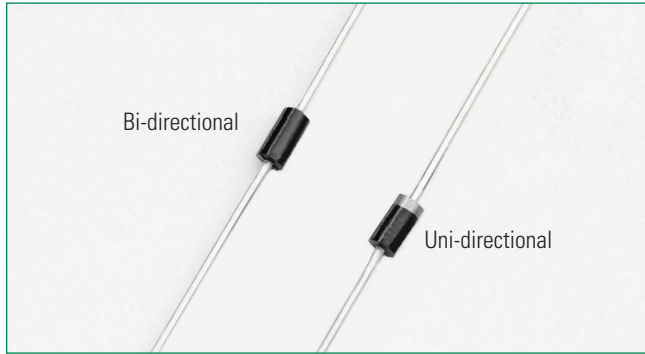


**P4KE Series**



**Agency Approvals**

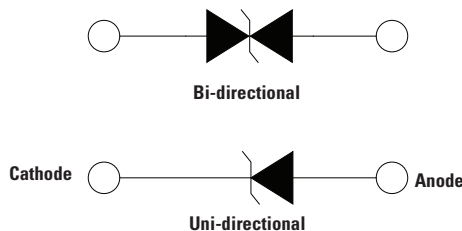
Agency	Agency File Number
	E230531

**Maximum Ratings and Thermal Characteristics (T<sub>A</sub>=25°C unless otherwise noted)**

Parameter	Symbol	Value	Unit
Peak Pulse Power Dissipation(Fig.2) by 10/1000us Test Waveform(Fig.4) (Note 1) -Single Die Parts	P <sub>PPM</sub>	400	W
Peak Pulse Power Dissipation(Fig.2) by 10/1000us Test Waveform(Fig.4) (Note 1) -Stacked Die Parts (Note 4)	P <sub>PPM</sub>	600	W
Steady State Power Dissipation on Infinite Heat Sink at T <sub>L</sub> =75°C	P <sub>D</sub>	1.5	W
Peak Forward Surge Current, 8.3ms Single Half Sine Wave Unidirectional Only (Note 2)	I <sub>FSM</sub>	60	A
Maximum Instantaneous Forward Voltage at 25A for Unidirectional Only (Note 3)	V <sub>F</sub>	3.5/5.0	V
Operating Junction and Storage Temperature Range	T <sub>J</sub> , T <sub>STG</sub>	-55 to 175	°C
Typical Thermal Resistance Junction to Lead	R <sub>θJL</sub>	60	°C/W
Typical Thermal Resistance Junction to Ambient	R <sub>θJA</sub>	100	°C/W

- Notes:**
1. Non-repetitive current pulse, per Fig. 4 and derated above T<sub>J</sub> (initial) = 25°C per Fig. 3.
  2. Measured on 8.3ms single half sine wave or equivalent square wave, duty cycle=4 per minute maximum.
  3. V<sub>F</sub> < 3.5V for single die parts and V<sub>F</sub> < 5.0V for stacked-die parts.
  4. For stacked die component details, please refer to part numbers labeled by \* in Electrical Characteristics.

**Functional Diagram**



**Description**

The P4KE Series is designed specifically to protect sensitive electronic equipment from EFTs, ESD, and induced lightning transients.

**Features**

- 400W peak pulse capability at 10/1000µs waveform, repetition rate (duty cycles):0.01%
- Glass passivated chip junction in DO-41 Package
- Fast response time: typically less than 1.0ps from 0 Volts to V<sub>BR</sub> min
- Excellent clamping capability
- Typical failure mode is a short circuit
- Whisker test is conducted per Table 4a/4c of JEDEC JESD201A
- IEC 61000-4-2 ESD 30kV(Air), 30kV (Contact)
- EFT protection of data lines in accordance with IEC 61000-4-4
- Low incremental surge resistance
- Typical IR ≤ 1 µA for VBR min > 12.6 V
- High temperature reflow soldering guaranteed: 260°C/30sec / 0.375”(9.5mm) lead length, 5 lbs., (2.3kg) tension
- V<sub>BR</sub> @ T<sub>J</sub> = V<sub>BR</sub> @ 25°C x (1 + αT x (T<sub>J</sub> - 25)) (αT: Temperature Coefficient, typical value is 0.1%)
- UL Recognized compound meeting flammability rating V-0
- Halogen free and RoHS compliant
- Pb-free E3 means 2nd level interconnect is Pb-free and the terminal finish material is tin(Sn) (IPC/ JEDEC J-STD-609A.01)

**Applications**

TVS components are ideal for the protection of I/O interfaces, V<sub>CC</sub> bus and other vulnerable circuits used in telecom, computer, industrial ICT equipment and consumer electronic applications.

**Additional Information**



Datasheet



Resources



Samples

### Electrical Characteristics (T<sub>A</sub>=25°C unless otherwise noted)

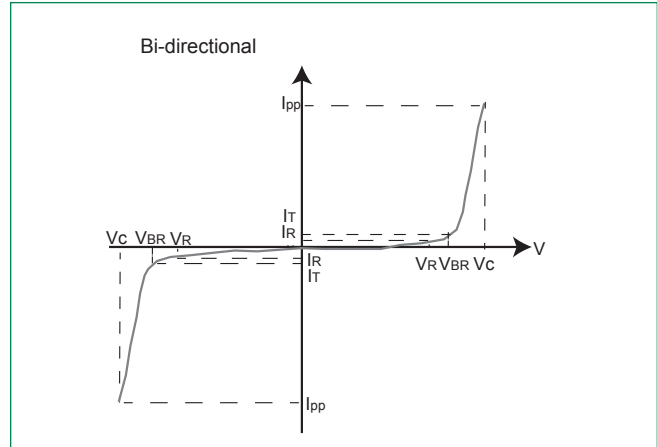
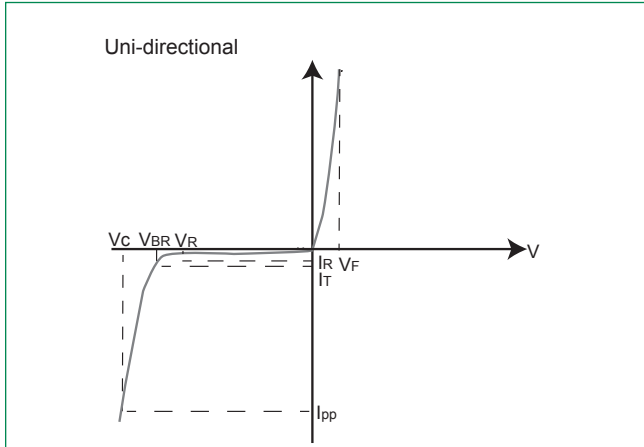
Part Number (Uni)	Part Number (Bi)	Reverse Stand off Voltage V <sub>R</sub> (Volts)	Breakdown Voltage V <sub>BR</sub> @ I <sub>T</sub> (V)		Test Current I <sub>T</sub> (mA)	Maximum Clamping Voltage V <sub>C</sub> @ I <sub>PP</sub> (V)	Maximum Peak Pulse Current I <sub>PP</sub> (A)	Maximum Reverse Leakage I <sub>R</sub> @ V <sub>R</sub> (μA)	Agency Approval 
			Min.	Max.					
P4KE6.8A	P4KE6.8CA	5.80	6.45	7.14	10	10.5	39.00	1000	X
P4KE7.5A	P4KE7.5CA	6.40	7.13	7.88	10	11.3	36.30	500	X
P4KE8.2A	P4KE8.2CA	7.02	7.79	8.61	10	12.1	33.90	200	X
P4KE9.1A	P4KE9.1CA	7.78	8.65	9.55	1	13.4	30.60	50	X
P4KE10A	P4KE10CA	8.55	9.50	10.50	1	14.5	28.30	10	X
P4KE11A	P4KE11CA	9.40	10.50	11.60	1	15.6	26.30	5	X
P4KE12A	P4KE12CA	10.20	11.40	12.60	1	16.7	24.60	5	X
P4KE13A	P4KE13CA	11.10	12.40	13.70	1	18.2	22.50	1	X
P4KE15A	P4KE15CA	12.80	14.30	15.80	1	21.2	19.30	1	X
P4KE16A	P4KE16CA	13.60	15.20	16.80	1	22.5	18.20	1	X
P4KE18A	P4KE18CA	15.30	17.10	18.90	1	25.5	16.10	1	X
P4KE20A	P4KE20CA	17.10	19.00	21.00	1	27.7	14.80	1	X
P4KE22A	P4KE22CA	18.80	20.90	23.10	1	30.6	13.40	1	X
P4KE24A	P4KE24CA	20.50	22.80	25.20	1	33.2	12.30	1	X
P4KE27A	P4KE27CA	23.10	25.70	28.40	1	37.5	10.90	1	X
P4KE30A	P4KE30CA	25.60	28.50	31.50	1	41.4	9.90	1	X
P4KE33A	P4KE33CA	28.20	31.40	34.70	1	45.7	9.00	1	X
P4KE36A	P4KE36CA	30.80	34.20	37.80	1	49.9	8.20	1	X
P4KE39A	P4KE39CA	33.30	37.10	41.00	1	53.9	7.60	1	X
P4KE43A	P4KE43CA	36.80	40.90	45.20	1	59.3	6.90	1	X
P4KE47A	P4KE47CA	40.20	44.70	49.40	1	64.8	6.30	1	X
P4KE51A	P4KE51CA	43.60	48.50	53.60	1	70.1	5.80	1	X
P4KE56A	P4KE56CA	47.80	53.20	58.80	1	77.0	5.30	1	X
P4KE62A	P4KE62CA	53.00	58.90	65.10	1	85.0	4.80	1	X
P4KE68A	P4KE68CA	58.10	64.60	71.40	1	92.0	4.50	1	X
P4KE75A	P4KE75CA	64.10	71.30	78.80	1	103.0	4.00	1	X
P4KE82A	P4KE82CA	70.10	77.90	86.10	1	113.0	3.60	1	X
P4KE91A	P4KE91CA	77.80	86.50	95.50	1	125.0	3.30	1	X
P4KE100A	P4KE100CA	85.50	95.00	105.00	1	137.0	3.00	1	X
P4KE110A	-	94.00	105.00	116.00	1	152.0	2.70	1	X
-	P4KE110CA*	94.00	105.00	116.00	1	152.0	4.00	1	X
P4KE120A	-	102.00	114.00	126.00	1	165.0	2.50	1	X
-	P4KE120CA*	102.00	114.00	126.00	1	165.0	3.70	1	X
P4KE130A	-	111.00	124.00	137.00	1	179.0	2.30	1	X
-	P4KE130CA*	111.00	124.00	137.00	1	179.0	3.40	1	X
P4KE150A	-	128.00	143.00	158.00	1	207.0	2.00	1	X
-	P4KE150CA*	128.00	143.00	158.00	1	207.0	2.90	1	X
P4KE160A	-	136.00	152.00	168.00	1	219.0	1.90	1	X
-	P4KE160CA*	136.00	152.00	168.00	1	219.0	2.80	1	X
P4KE170A	-	145.00	162.00	179.00	1	234.0	1.80	1	X
-	P4KE170CA*	145.00	162.00	179.00	1	234.0	2.60	1	X
P4KE180A	-	154.00	171.00	189.00	1	246.0	1.70	1	X
-	P4KE180CA*	154.00	171.00	189.00	1	246.0	2.50	1	X
P4KE200A	-	171.00	190.00	210.00	1	274.0	1.50	1	X
-	P4KE200CA*	171.00	190.00	210.00	1	274.0	2.20	1	X
P4KE220A	-	185.00	209.00	231.00	1	328.0	1.30	1	-
-	P4KE220CA*	185.00	209.00	231.00	1	328.0	1.90	1	-
P4KE250A	-	214.00	237.00	263.00	1	344.0	1.20	1	-
-	P4KE250CA*	214.00	237.00	263.00	1	344.0	1.80	1	-
P4KE300A	-	256.00	285.00	315.00	1	414.0	1.00	1	-
-	P4KE300CA*	256.00	285.00	315.00	1	414.0	1.50	1	-
P4KE350A*	P4KE350CA*	300.00	332.00	368.00	1	482.0	1.30	1	-
P4KE400A*	P4KE400CA*	342.00	380.00	420.00	1	548.0	1.10	1	-
P4KE440A*	P4KE440CA*	376.00	418.00	462.00	1	602.0	1.00	1	-
P4KE480A*	P4KE480CA*	408.00	456.00	504.00	1	658.0	0.92	1	-
P4KE510A*	P4KE510CA*	434.00	485.00	535.00	1	698.0	0.86	1	-
P4KE530A*	P4KE530CA*	451.00	503.50	556.50	1	725.0	0.83	1	-
P4KE540A*	P4KE540CA*	460.00	513.00	567.00	1	740.0	0.82	1	-
P4KE550A*	P4KE550CA*	468.00	522.50	577.50	1	760.0	0.79	1	-

For bidirectional type having V<sub>R</sub> of 10 volts and less, the I<sub>R</sub> value is double.

For parts without A, the V<sub>BR</sub> is ± 10% and V<sub>C</sub> is 5% higher than with A parts, the parts without A are currently available, but not recommended for new designs. The parts with A are preferred.

For stack-die parts, use \* to label the part number.

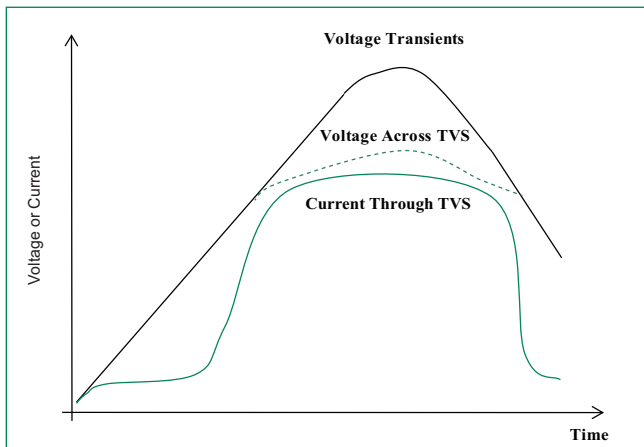
**I-V Curve Characteristics**



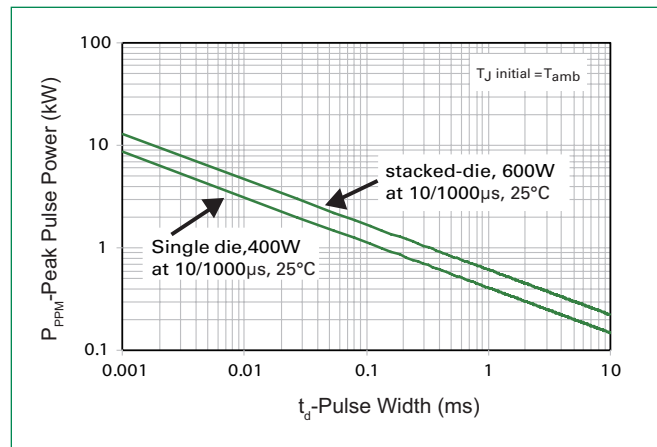
- P<sub>PPM</sub>** Peak Pulse Power Dissipation – Max power dissipation
- V<sub>R</sub>** Stand-off Voltage – Maximum voltage that can be applied to the TVS without operation
- V<sub>BR</sub>** Breakdown Voltage – Maximum voltage that flows through the TVS at a specified test current (I<sub>T</sub>)
- V<sub>C</sub>** Clamping Voltage – Peak voltage measured across the TVS at a specified I<sub>ppm</sub> (peak impulse current)
- I<sub>R</sub>** Reverse Leakage Current – Current measured at V<sub>R</sub>
- V<sub>F</sub>** Forward Voltage Drop for Uni-directional

**Ratings and Characteristic Curves (T<sub>A</sub>=25°C unless otherwise noted)**

**Figure 1 - TVS Transients Clamping Waveform**

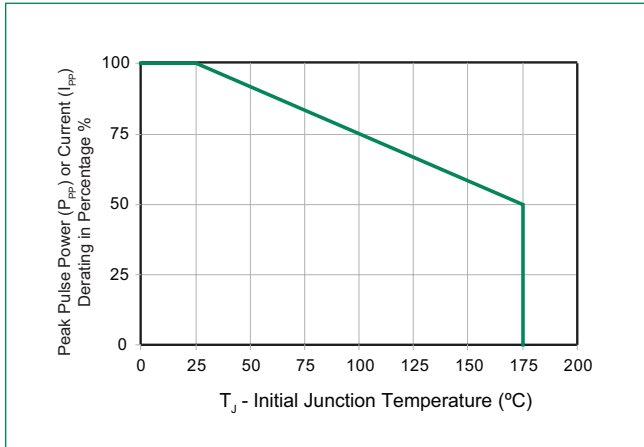


**Figure 2 - Peak Pulse Power Rating Curve**

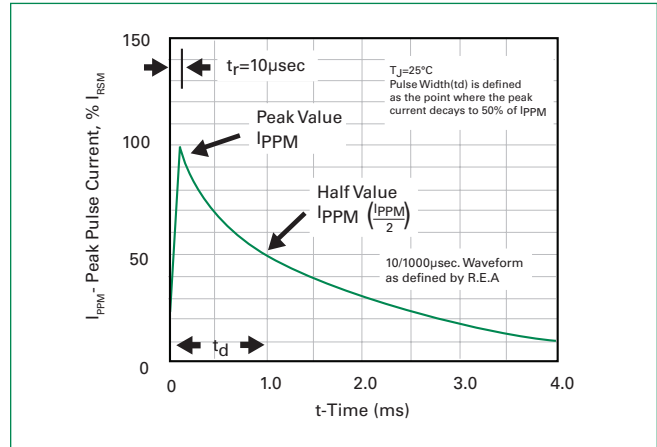


**Ratings and Characteristic Curves** ( $T_A=25^\circ\text{C}$  unless otherwise noted) (Continued)

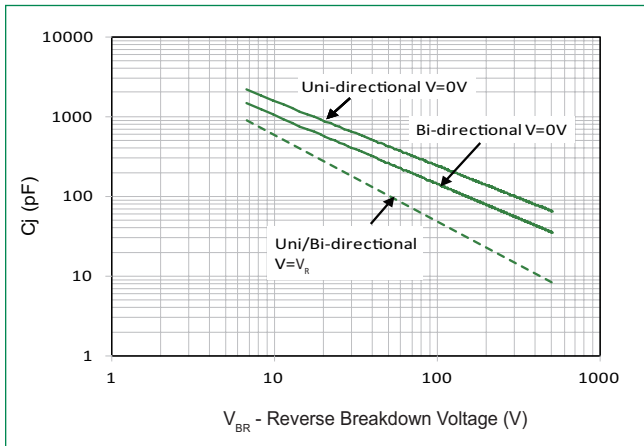
**Figure 3 - Peak Pulse Power Derating Curve**



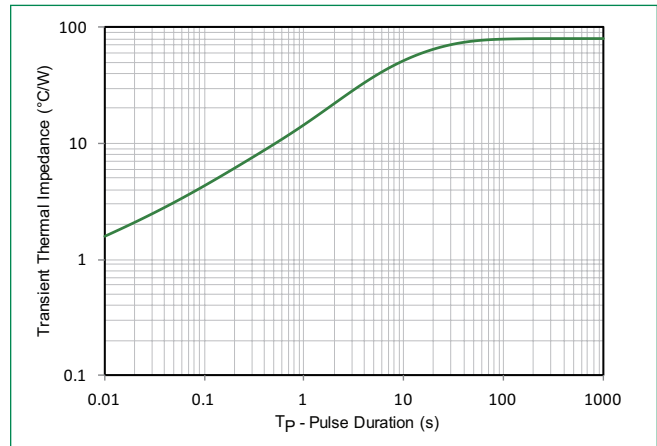
**Figure 4 - Pulse Waveform**



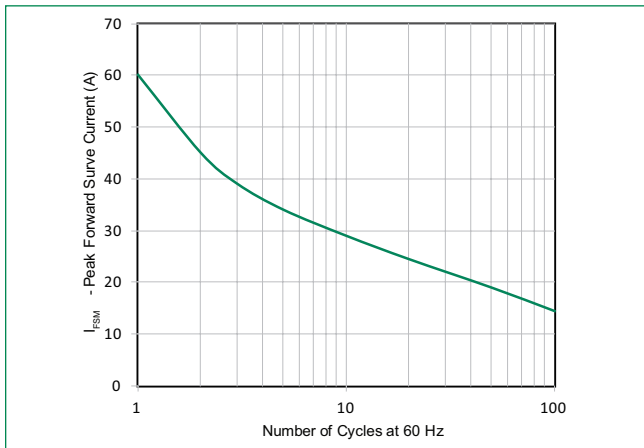
**Figure 5 - Typical Junction Capacitance**



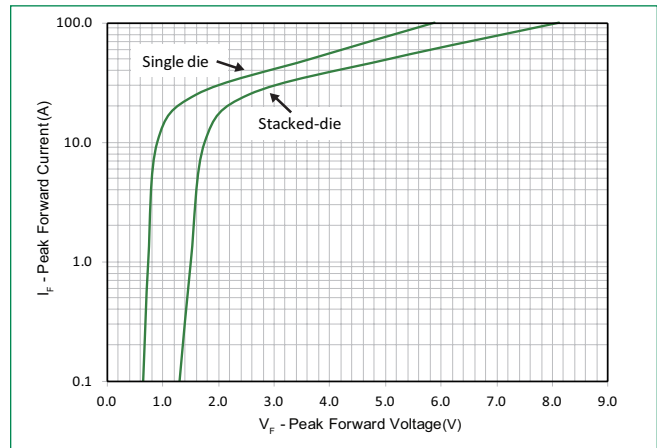
**Figure 6 - Typical Transient Thermal Impedance**



**Figure 7 - Maximum Non-Repetitive Forward Surge Current Uni-Directional Only**

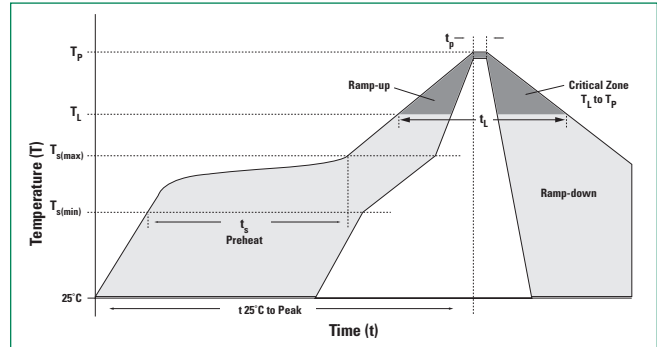


**Figure 8 - Peak Forward Voltage Drop vs Peak Forward Current (Typical Values)**



### Soldering Parameters

<b>Reflow Condition</b>		Lead-free assembly
<b>Pre Heat</b>	- Temperature Min ( $T_{s(min)}$ )	150°C
	- Temperature Max ( $T_{s(max)}$ )	200°C
	- Time (min to max) ( $t_s$ )	60 – 120 secs
<b>Average ramp up rate (Liquidus Temp (<math>T_L</math>) to peak)</b>		3°C/second max
<b><math>T_{s(max)}</math> to <math>T_L</math> - Ramp-up Rate</b>		3°C/second max
<b>Reflow</b>	- Temperature ( $T_L$ ) (Liquidus)	217°C
	- Time (min to max) ( $t_L$ )	60 – 150 seconds
<b>Peak Temperature (<math>T_p</math>)</b>		260 <sup>+0/-5</sup> °C
<b>Time within 5°C of actual peak Temperature (<math>t_p</math>)</b>		30 seconds max
<b>Ramp-down Rate</b>		6°C/second max
<b>Time 25°C to peak Temperature (<math>T_p</math>)</b>		8 minutes Max.
<b>Do not exceed</b>		260°C



### Flow/Wave Soldering (Solder Dipping)

<b>Peak Temperature :</b>	260°C
<b>Dipping Time :</b>	5 seconds
<b>Soldering :</b>	1 time

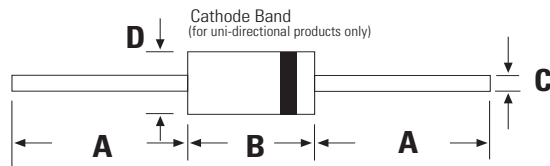
### Physical Specifications

<b>Weight</b>	0.012oz., 0.3g
<b>Case</b>	JEDEC DO-204AL (DO-41) molded plastic body over passivated junction.
<b>Polarity</b>	Colored band indicates unidirectional component's cathode end
<b>Terminal</b>	Matte Tin axial leads, solderable per JESD22-B102.

### Environmental Specifications

<b>High Temp. Storage</b>	JESD22-A103
<b>HTRB</b>	JESD22-A108
<b>Temperature Cycling</b>	JESD22-A104
<b>H3TRB</b>	JESD22-A101
<b>RSH</b>	JESD22-B106

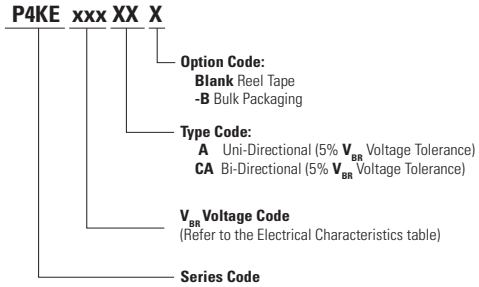
### Dimensions



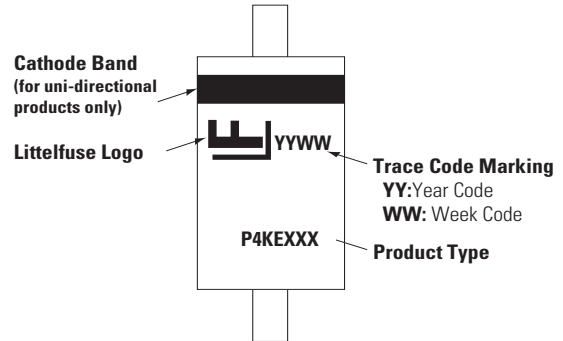
DO-204AL (DO-41)

Dimensions	Inches		Millimeters	
	Min	Max	Min	Max
A	1.000	-	25.40	-
B	0.160	0.205	4.10	5.20
C	0.028	0.034	0.71	0.86
D	0.080	0.107	2.00	2.70

### Part Numbering System



### Part Marking System



### Packaging

Part Number	Component Package	Quantity	Packaging Option	Packaging Specification
P4KExxxXX	DO-204AL	5000	Tape & Reel	EIA STD RS-296
P4KExxxXX-B	DO-204AL	500	BOX	Littelfuse Spec.

### Tape and Reel Specification

