

P4SMA Series

Surface Mount – 400W



Additional Information



Resources



Accessories



Samples

Maximum Ratings and Thermal Characteristics

($T_A=25^\circ\text{C}$ unless otherwise noted)

| Parameter | Symbol | Value | Unit |
|---|-----------------|------------|---------------------------|
| Peak Pulse Power Dissipation at $T_A=25^\circ\text{C}$ by 10/1000us Waveform(Fig.2)(Note 1), (Note 2)Single Die Parts | P_{PPM} | 400 | W |
| Peak Pulse Power Dissipation at $T_A=25^\circ\text{C}$ by 10/1000us Waveform(Fig.2)(Note 1), (Note 2) Stacked Die Parts(Note 5) | P_{PPM} | 600 | W |
| Power Dissipation on Infinite Heat Sink at $T_L=50^\circ\text{C}$ | P_D | 3.3 | W |
| Peak Forward Surge Current, 8.3ms Single Half Sine Wave (Note 3) | I_{FSM} | 60 | A |
| Maximum Instantaneous Forward Voltage at 25A for Unidirectional Only (Note 4) | V_F | 3.5/5.0 | V |
| Operating Temperature Range | T_J | -65 to 150 | $^\circ\text{C}$ |
| Storage Temperature Range | T_{STG} | -65 to 175 | $^\circ\text{C}$ |
| Typical Thermal Resistance Junction to Lead | $R_{\theta JL}$ | 30 | $^\circ\text{C}/\text{W}$ |
| Typical Thermal Resistance Junction to Ambient | $R_{\theta JA}$ | 120 | $^\circ\text{C}/\text{W}$ |

Notes:

1. Non-repetitive current pulse, per Fig.4 and derated above T_J (initial) $=25^\circ\text{C}$ per Fig. 3.
2. Mounted on 5.0x5.0mm copper pad to each terminal.
3. Measured on 8.3ms single half sine wave or equivalent square wave for unidirectional device only.
4. $V_F < 3.5\text{V}$ for single die parts and $V_F < 5.0\text{V}$ for stacked-die parts.
5. For stacked die component details, please refer to part numbers labeled by * in Electrical Characteristics.

Description

The P4SMA series is designed specifically to protect sensitive electronic equipment from voltage transients induced by lightning and other transient voltage events.

Features

- 400W peak pulse power capability at 10/1000 μs waveform, repetition rate (duty cycles):0.01%
- Excellent clamping capability
- Typical IR less than 1 μA when $V_{BR\ min} > 12\text{V}$
- Surface mount footprint for compact PCB layout
- Low profile package
- Typical failure mode due to exceeding maximum ratings is a short circuit condition
- Whisker test conducted based on Table 4a and 4c of JEDEC JESD201A
- IEC 61000-4-2 ESD 30kV(Air), 30kV (Contact)
- Built-in strain relief
- Fast response time: typically less than 1.0ps from 0V to BV min
- 260 $^\circ\text{C}$ /40sec change to 260 $^\circ\text{C}$ /30sec
- $V_{BR} @ T_J = V_{BR} @ 25^\circ\text{C} \times (1 + \alpha T \times (T_J - 25))$ (αT : Temperature Coefficient, typical value is 0.1%)
- Plastic package is flammability rated V-0 per UL-94.
- Meet MSL level1, per J-STD-020, LF maximum peak of 260 $^\circ\text{C}$
- Matte tin, lead-free plated
- Halogen-free and RoHS compliant
- Pb-free E3 means 2nd level interconnect is Pb-free and the terminal finish material is tin(Sn) (IPC/JEDEC J-STD-609A.01)

Applications

TVS devices are ideal for the protection of I/O Interfaces, VCC bus and other vulnerable circuits used in Telecom, Computer, Industrial and Consumer electronic applications.

Agency Approvals

| Agency | Agency File Number |
|--------|--------------------|
| | E230531 |

Functional Diagram



Bi-directional

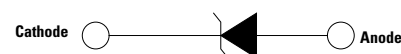

Uni-directional

P4SMA Series

Surface Mount – 400W

Electrical Characteristics ($T_A=25^\circ\text{C}$ unless otherwise noted)

| Part Number (Uni) | Part Number (Bi) | Marking | | Reverse Stand off Voltage V_R (Volts) | Breakdown Voltage V_{BR} (Volts) @ I_T | | Test Current I_T (mA) | Maximum Clamping Voltage V_C @ I_{PP} (V) | Maximum Peak Pulse Current I_{PP} (A) | Maximum Reverse Leakage I_R @ V_R (μA) | Maximum Temperature Coefficient of V_{BR} (%/C) | Agency Approval |
|-------------------|------------------|-----------|------------|---|--|--------|-------------------------|---|---|---|---|-----------------|
| | | Uni | Bi | | Min | Max | | | | | | |
| | | P4SMA6.8A | P4SMA6.8CA | | 6V8A | 6V8C | | | | | | |
| P4SMA7.5A | P4SMA7.5CA | 7V5A | 7V5C | 6.40 | 7.13 | 7.88 | 10 | 11.3 | 36.3 | 500 | 0.052 | X |
| P4SMA8.2A | P4SMA8.2CA | 8V2A | 8V2C | 7.02 | 7.79 | 8.61 | 10 | 12.1 | 33.9 | 200 | 0.058 | X |
| P4SMA9.1A | P4SMA9.1CA | 9V1A | 9V1C | 7.78 | 8.65 | 9.55 | 1 | 13.4 | 30.6 | 50 | 0.063 | X |
| P4SMA10A | P4SMA10CA | 10A | 10C | 8.55 | 9.50 | 10.50 | 1 | 14.5 | 28.3 | 10 | 0.066 | X |
| P4SMA11A | P4SMA11CA | 11A | 11C | 9.40 | 10.50 | 11.60 | 1 | 15.6 | 26.3 | 5 | 0.069 | X |
| P4SMA12A | P4SMA12CA | 12A | 12C | 10.20 | 11.40 | 12.60 | 1 | 16.7 | 24.6 | 5 | 0.071 | X |
| P4SMA13A | P4SMA13CA | 13A | 13C | 11.10 | 12.40 | 13.70 | 1 | 18.2 | 22.5 | 1 | 0.074 | X |
| P4SMA15A | P4SMA15CA | 15A | 15C | 12.80 | 14.30 | 15.80 | 1 | 21.2 | 19.3 | 1 | 0.076 | X |
| P4SMA16A | P4SMA16CA | 16A | 16C | 13.60 | 15.20 | 16.80 | 1 | 22.5 | 18.2 | 1 | 0.080 | X |
| P4SMA18A | P4SMA18CA | 18A | 18C | 15.30 | 17.10 | 18.90 | 1 | 25.5 | 16.1 | 1 | 0.083 | X |
| P4SMA20A | P4SMA20CA | 20A | 20C | 17.10 | 19.00 | 21.00 | 1 | 27.7 | 14.8 | 1 | 0.085 | X |
| P4SMA22A | P4SMA22CA | 22A | 22C | 18.80 | 20.90 | 23.10 | 1 | 30.6 | 13.4 | 1 | 0.088 | X |
| P4SMA24A | P4SMA24CA | 24A | 24C | 20.50 | 22.80 | 25.20 | 1 | 33.2 | 12.3 | 1 | 0.091 | X |
| P4SMA27A | P4SMA27CA | 27A | 27C | 23.10 | 25.70 | 28.40 | 1 | 37.5 | 10.9 | 1 | 0.092 | X |
| P4SMA30A | P4SMA30CA | 30A | 30C | 25.60 | 28.50 | 31.50 | 1 | 41.4 | 9.9 | 1 | 0.093 | X |
| P4SMA33A | P4SMA33CA | 33A | 33C | 28.20 | 31.40 | 34.70 | 1 | 45.7 | 9.0 | 1 | 0.094 | X |
| P4SMA36A | P4SMA36CA | 36A | 36C | 30.80 | 34.20 | 37.80 | 1 | 49.9 | 8.2 | 1 | 0.096 | X |
| P4SMA39A | P4SMA39CA | 39A | 39C | 33.30 | 37.10 | 41.00 | 1 | 53.9 | 7.6 | 1 | 0.097 | X |
| P4SMA43A | P4SMA43CA | 43A | 43C | 36.80 | 40.90 | 45.20 | 1 | 59.3 | 6.9 | 1 | 0.098 | X |
| P4SMA47A | P4SMA47CA | 47A | 47C | 40.20 | 44.70 | 49.40 | 1 | 64.8 | 6.3 | 1 | 0.099 | X |
| P4SMA51A | P4SMA51CA | 51A | 51C | 43.60 | 48.50 | 53.60 | 1 | 70.1 | 5.8 | 1 | 0.100 | X |
| P4SMA56A | P4SMA56CA | 56A | 56C | 47.80 | 53.20 | 58.80 | 1 | 77.0 | 5.3 | 1 | 0.101 | X |
| P4SMA62A | P4SMA62CA | 62A | 62C | 53.00 | 58.90 | 65.10 | 1 | 85.0 | 4.8 | 1 | 0.102 | X |
| P4SMA68A | P4SMA68CA | 68A | 68C | 58.10 | 64.60 | 71.40 | 1 | 92.0 | 4.5 | 1 | 0.103 | X |
| P4SMA75A | P4SMA75CA | 75A | 75C | 64.10 | 71.30 | 78.80 | 1 | 103.0 | 4.0 | 1 | 0.104 | X |
| P4SMA82A | P4SMA82CA | 82A | 82C | 70.10 | 77.90 | 86.10 | 1 | 113.0 | 3.6 | 1 | 0.105 | X |
| P4SMA91A | P4SMA91CA | 91A | 91C | 77.80 | 86.50 | 95.50 | 1 | 125.0 | 3.3 | 1 | 0.106 | X |
| P4SMA100A | P4SMA100CA | 100A | 100C | 85.50 | 95.00 | 105.00 | 1 | 137.0 | 3.0 | 1 | 0.106 | X |
| P4SMA110A | P4SMA110CA | 110A | 110C | 94.00 | 105.00 | 116.00 | 1 | 152.0 | 2.7 | 1 | 0.107 | X |
| P4SMA120A | P4SMA120CA | 120A | 120C | 102.00 | 114.00 | 126.00 | 1 | 165.0 | 2.5 | 1 | 0.107 | X |
| P4SMA130A | P4SMA130CA | 130A | 130C | 111.00 | 124.00 | 137.00 | 1 | 179.0 | 2.3 | 1 | 0.107 | X |
| P4SMA150A | P4SMA150CA | 150A | 150C | 128.00 | 143.00 | 158.00 | 1 | 207.0 | 2.0 | 1 | 0.108 | X |
| P4SMA160A | P4SMA160CA | 160A | 160C | 136.00 | 152.00 | 168.00 | 1 | 219.0 | 1.9 | 1 | 0.108 | X |
| P4SMA170A | P4SMA170CA | 170A | 170C | 145.00 | 162.00 | 179.00 | 1 | 234.0 | 1.8 | 1 | 0.108 | X |
| P4SMA180A | P4SMA180CA | 180A | 180C | 154.00 | 171.00 | 189.00 | 1 | 246.0 | 1.7 | 1 | 0.108 | X |
| P4SMA200A | P4SMA200CA | 200A | 200C | 171.00 | 190.00 | 210.00 | 1 | 274.0 | 1.5 | 1 | 0.108 | X |
| P4SMA220A | P4SMA220CA | 220A | 220C | 185.00 | 209.00 | 231.00 | 1 | 328.0 | 1.3 | 1 | 0.110 | X |
| P4SMA250A | - | 250A | - | 214.00 | 237.00 | 263.00 | 1 | 344.0 | 1.2 | 1 | 0.110 | X |
| - | P4SMA250CA* | - | 250C | 214.00 | 237.00 | 263.00 | 1 | 344.0 | 1.8 | 1 | 0.110 | X |
| P4SMA300A | - | 300A | - | 256.00 | 285.00 | 315.00 | 1 | 414.0 | 1.0 | 1 | 0.110 | X |
| - | P4SMA300CA* | - | 300C | 256.00 | 285.00 | 315.00 | 1 | 414.0 | 1.5 | 1 | 0.110 | X |
| P4SMA350A* | P4SMA350CA* | 350A | 350C | 300.00 | 332.00 | 368.00 | 1 | 482.0 | 1.3 | 1 | 0.112 | X |
| P4SMA400A* | P4SMA400CA* | 400A | 400C | 342.00 | 380.00 | 420.00 | 1 | 548.0 | 1.1 | 1 | 0.112 | X |
| P4SMA440A* | P4SMA440CA* | 440A | 440C | 376.00 | 418.00 | 462.00 | 1 | 602.0 | 1.0 | 1 | 0.112 | X |
| P4SMA480A* | P4SMA480CA* | 480A | 480C | 408.00 | 456.00 | 504.00 | 1 | 658.0 | 1.0 | 1 | 0.112 | X |
| P4SMA510A* | P4SMA510CA* | 510A | 510C | 434.00 | 485.00 | 535.00 | 1 | 698.0 | 0.9 | 1 | 0.112 | X |
| P4SMA530A* | P4SMA530CA* | 530A | 530C | 451.00 | 503.50 | 556.50 | 1 | 725.0 | 0.9 | 1 | 0.112 | X |
| P4SMA540A* | P4SMA540CA* | 540A | 540C | 460.00 | 513.00 | 567.00 | 1 | 740.0 | 0.9 | 1 | 0.112 | X |
| P4SMA550A* | P4SMA550CA* | 550A | 550C | 468.00 | 522.50 | 577.50 | 1 | 760.0 | 0.8 | 1 | 0.112 | X |

For bidirectional type having V_R of 10 volts and less, the I_R limit is double.
 $V_{BR} @ T_A = V_{BR} @ 25^\circ\text{C} \times (1 + \alpha T \times (T_J - 25))$ (α : Temperature Coefficient)
 For stack-die parts, use * to label the part number.

P4SMA Series

Surface Mount – 400W

I-V Curve Characteristics

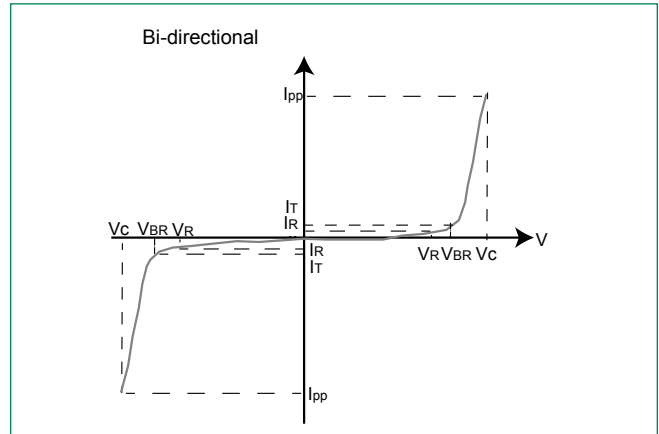
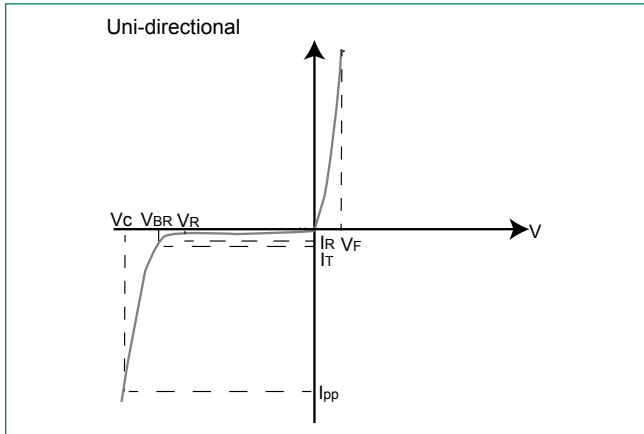

- P_{PPM} **Peak Pulse Power Dissipation** – Max power dissipation
- V_R **Stand-off Voltage** – Maximum voltage that can be applied to the TVS without operation
- V_{BR} **Breakdown Voltage** – Maximum voltage that flows through the TVS at a specified test current (I_T)
- V_C **Clamping Voltage** – Peak voltage measured across the TVS at a specified I_{ppm} (peak impulse current)
- I_R **Reverse Leakage Current** – Current measured at V_R
- V_F **Forward Voltage Drop for Uni-directional**

Ratings and Characteristic Curves ($T_A=25^\circ\text{C}$ unless otherwise noted)

Figure 1:
TVS Transients Clamping Waveform

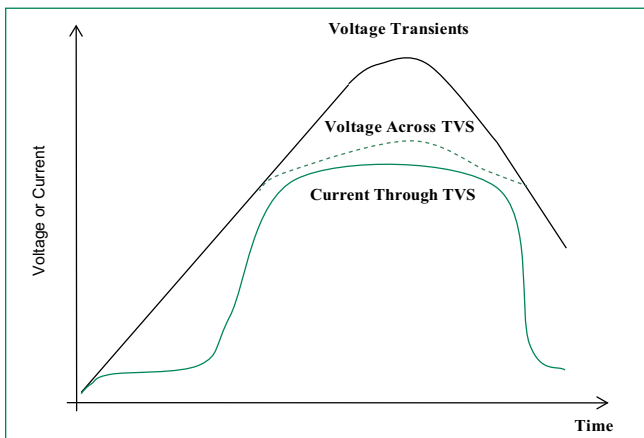
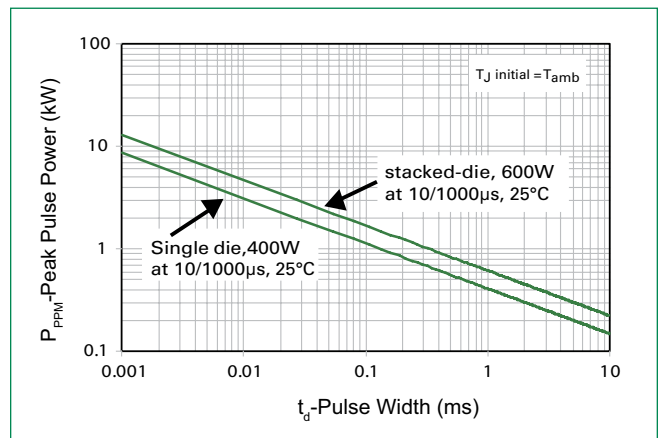

Figure 2:
Peak Pulse Power Rating Curve



P4SMA Series

Surface Mount – 400W

Ratings and Characteristic Curves ($T_A=25^\circ\text{C}$ unless otherwise noted) (Continued)

Figure 3:
Peak Pulse Power Derating Curve

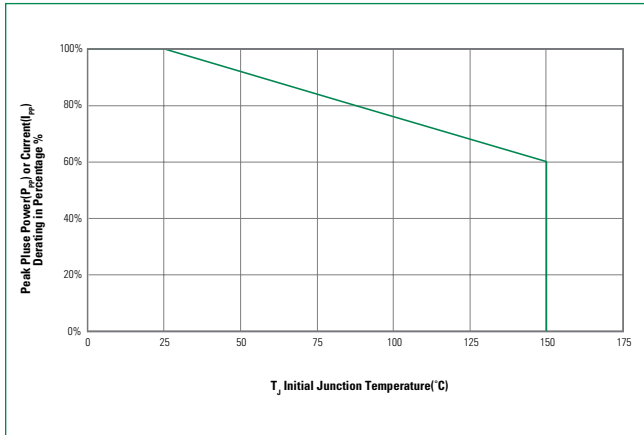

Figure 4:
Pulse Waveform

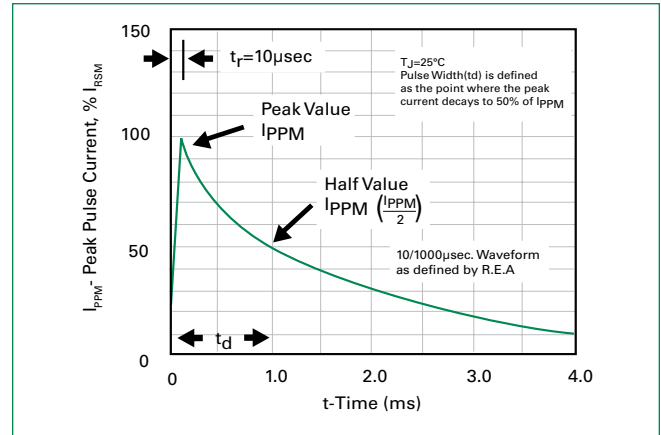

Figure 5:
Typical Junction Capacitance

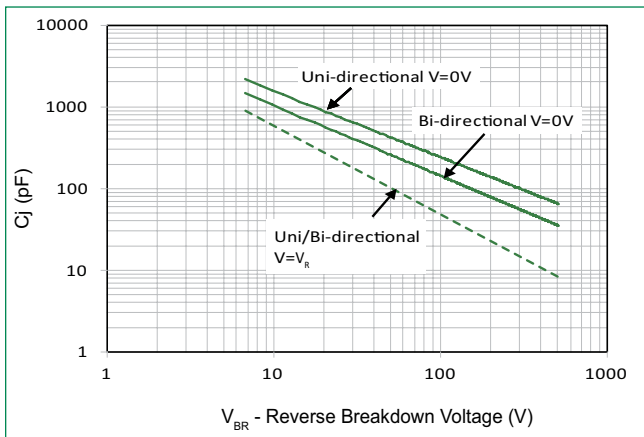

Figure 6:
Typical Transient Thermal Impedance

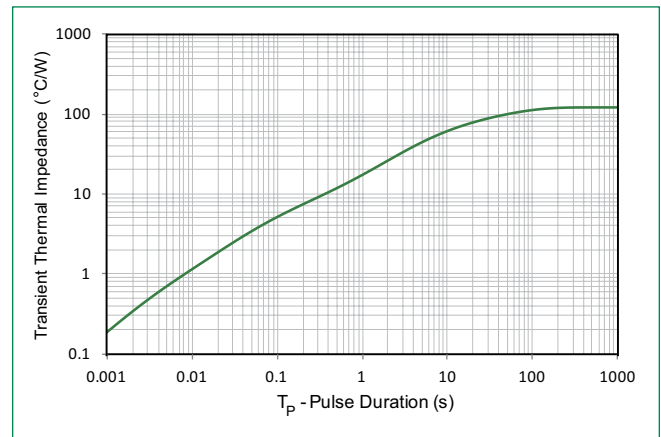

Figure 7:
Maximum Non-Repetitive Forward Surge Current
Uni-Directional Only

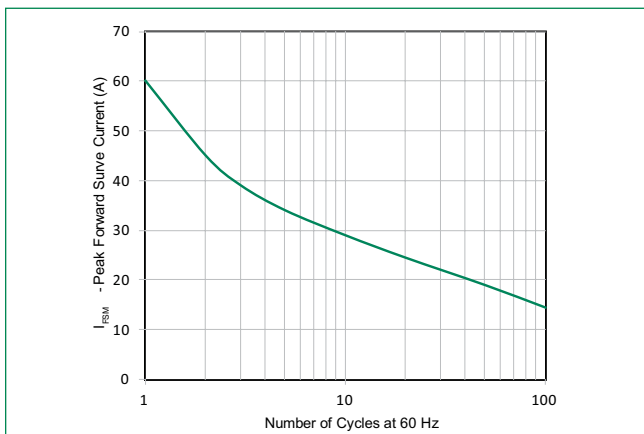
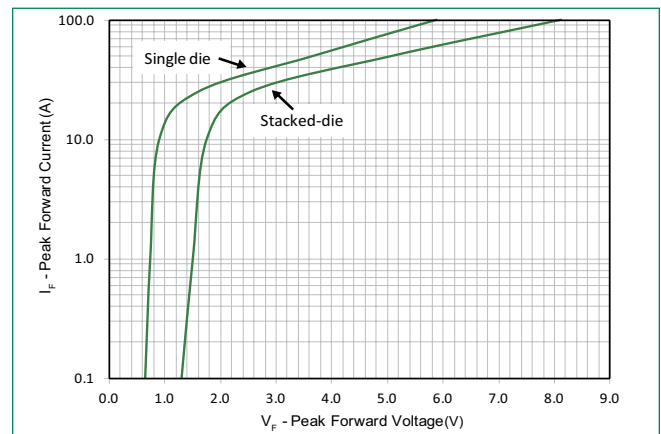

Figure 8:
Peak Forward Voltage Drop vs Peak Forward Current
(Typical Values)



P4SMA Series

Surface Mount – 400W

Soldering Parameters

| | | |
|--|------------------------------------|-------------------------|
| Reflow Condition | | Lead-free assembly |
| Pre Heat | - Temperature Min ($T_{s(min)}$) | 150°C |
| | - Temperature Max ($T_{s(max)}$) | 200°C |
| | - Time (min to max) (t_s) | 60 – 120 secs |
| Average ramp up rate (Liquidus Temp (T_L) to peak) | | 3°C/second max |
| $T_{s(max)}$ to T_L - Ramp-up Rate | | 3°C/second max |
| Reflow | - Temperature (T_L) (Liquidus) | 217°C |
| | - Time (min to max) (t_L) | 60 – 150 seconds |
| Peak Temperature (T_p) | | 260 ^{+0/-5} °C |
| Time within 5°C of actual peak Temperature (t_p) | | 30 seconds max |
| Ramp-down Rate | | 6°C/second max |
| Time 25°C to peak Temperature (T_p) | | 8 minutes Max. |
| Do not exceed | | 260°C |

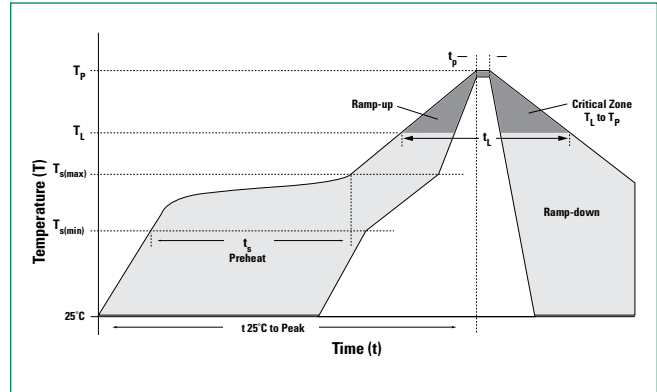

Physical Specifications

| | |
|-----------------|--|
| Weight | 0.002 ounce, 0.061 gram |
| Case | JEDEC DO-214AC. Molded plastic body over glass passivated junction |
| Polarity | Color band denotes positive end (cathode) except bidirectional |
| Terminal | Matte tin-plated leads, Solderable per JESD22-B102 |

Environmental Specifications

| | |
|----------------------------|--------------------------|
| High Temp. Storage | JESD22-A103 |
| HTRB | JESD22-A108 |
| Temperature Cycling | JESD22-A104 |
| MSL | JEDEC-J-STD-020, Level 1 |
| H3TRB | JESD22-A101 |
| RSH | JESD22-A111 |

Dimensions

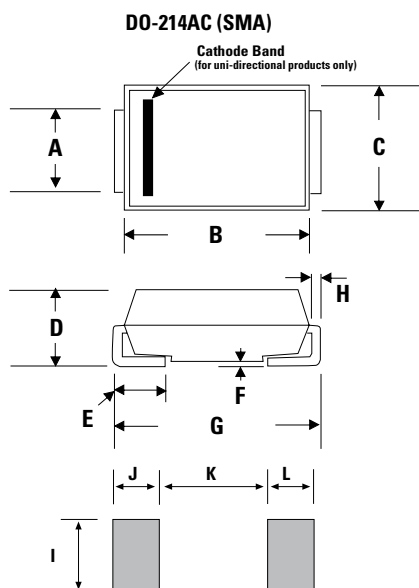

| Dimensions | Inches | | Millimeters | |
|------------|--------|-------|-------------|-------|
| | Min | Max | Min | Max |
| A | 0.049 | 0.065 | 1.250 | 1.650 |
| B | 0.157 | 0.181 | 3.990 | 4.600 |
| C | 0.095 | 0.110 | 2.400 | 2.790 |
| D | 0.075 | 0.090 | 1.900 | 2.290 |
| E | 0.030 | 0.060 | 0.780 | 1.520 |
| F | - | 0.008 | - | 0.203 |
| G | 0.189 | 0.208 | 4.800 | 5.280 |
| H | 0.006 | 0.012 | 0.152 | 0.305 |
| I | 0.070 | - | 1.800 | - |
| J | 0.082 | - | 2.100 | - |
| K | - | 0.090 | - | 2.300 |
| L | 0.082 | - | 2.100 | - |

P4SMA Series

Surface Mount – 400W

Part Numbering System

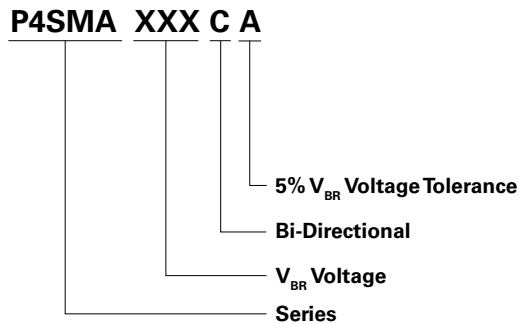

Part Marking System

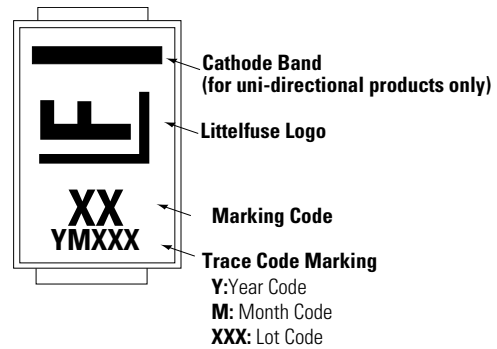

Packaging

| Part number | Component Package | Quantity | Packaging Option | Packaging Specification |
|-------------|-------------------|----------|----------------------------------|-------------------------|
| P4SMAxxxXX | DO-214AC | 5000 | Tape & Reel - 12mm tape/13" reel | EIA STD RS-481 |

Tape and Reel Specification

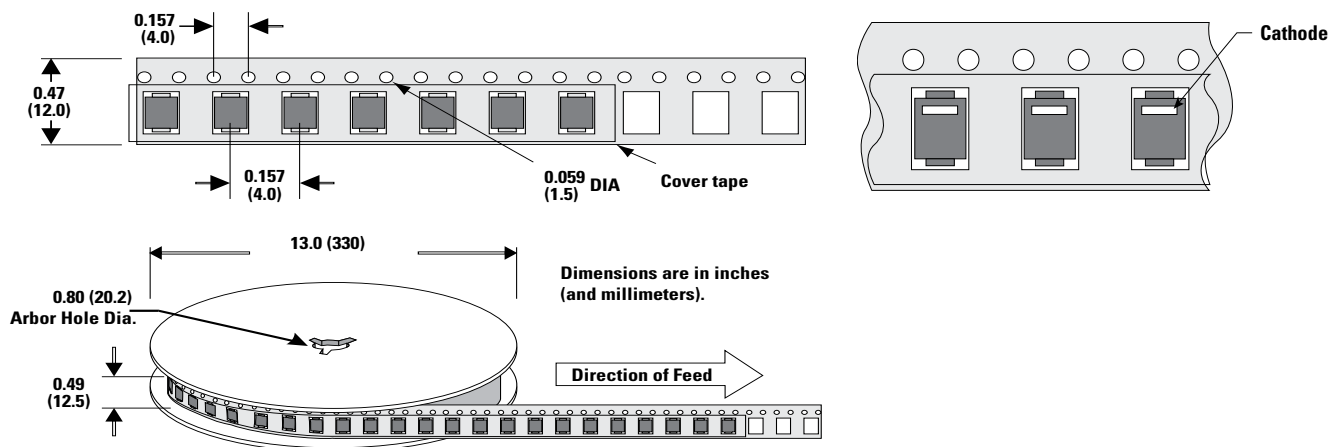

Disclaimer Notice - Information furnished is believed to be accurate and reliable. However, users should independently evaluate the suitability of and test each product selected for their own applications. Littelfuse products are not designed for, and may not be used in, all applications. Read complete Disclaimer Notice at www.littelfuse.com/disclaimer-electronics.