

TPSMB Asymmetric Series

Surface Mount – 600W

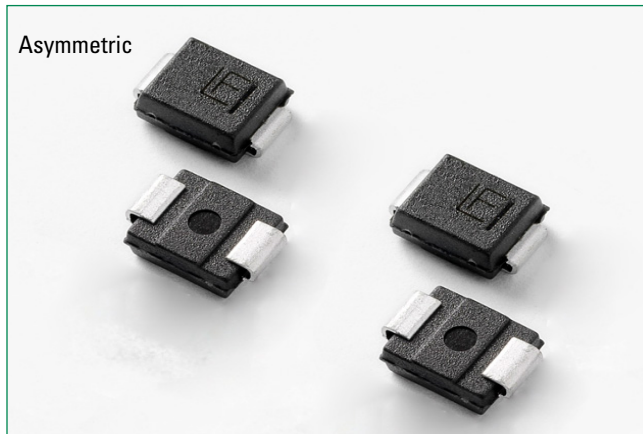

Maximum Ratings and Thermal Characteristics

($T_A=25^{\circ}\text{C}$ unless otherwise noted)

Parameter	Symbol	Value	Unit
Peak Pulse Power Dissipation ($I_{PP} \times V_C$) by 10/1000 μs waveform (Fig.1)(Note 1), (Note 2)	P_{PPM}^1	600	W
	P_{PPM}^2		
Power Dissipation on infinite heat sink at $T_J=50^{\circ}\text{C}$	P_{MAV}	5.0	W
Operating Junction Temperature Range	T_J	-65 to 175	$^{\circ}\text{C}$
Storage Temperature Range	T_{STG}	-65 to 175	
Typical Thermal Resistance Junction to Lead	$R_{\theta JL}$	20	$^{\circ}\text{C}/\text{W}$
Typical Thermal Resistance Junction to Ambient	$R_{\theta JA}$	100	$^{\circ}\text{C}/\text{W}$
Typical Junction Capacitance	C_J	650	pF

Notes:

1. Non-repetitive current pulse, per Fig.4 and derated above $T_A=25^{\circ}\text{C}$ per Fig. 3.
2. Mounted on copper pad area of 0.2x0.2" (5.0 x 5.0mm) to each terminal.

Pin out & Functional Diagram

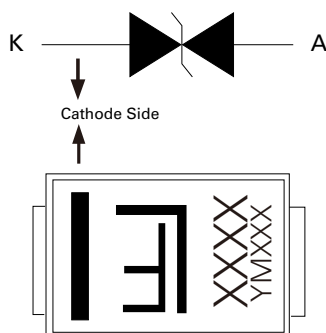

Description

The TPSMB Asymmetric Series is designed specifically to protect sensitive electronic equipment from voltage transients induced by lightning and other transient voltage events.

Features

- High reliability application and automotive grade AEC-Q101 qualified
- Surface mount component to optimize board space
- Low profile package
- Typical failure mode is short from over-specified voltage or current
- Whisker test is conducted based on JEDEC JESD201A per its table 4a and 4c
- ESD protection of data lines in accordance with IEC 61000-4-2, 30kV(Air), 30kV (Contact)
- EFT protection of data lines in accordance with IEC 61000-4-4
- Glass passivated chip junction
- 600W P_{PPM} peak pulse power capability at 10/1000 μs waveform, repetition rate (duty cycles):0.01%
- Fast response time: typically less than 1.0ns from 0V to V_{BR} min
- Excellent clamping capability
- Low incremental surge resistance
- UL Recognized compound meeting flammability rating V-0.
- Meet MSL level1, per J-STD-020, High temperature soldering guaranteed: 260 $^{\circ}\text{C}/10$ seconds at terminals
- Matte tin lead-free plated
- Halogen free and RoHS compliant
- Pb-free E3 means 2nd level interconnect is Pb-free and the terminal finish material is tin(Sn) (IPC/JEDEC J-STD-609A.01)



Applications

TVS components are ideal for the protection of I/O Interfaces, VCC bus and other vulnerable circuits used in Automotive applications.

TPSMB Asymmetric Series

Surface Mount – 600W

Electrical Characteristics ($T_A=25^\circ\text{C}$ unless otherwise noted)

Part Number	Marking	K \rightarrow 							 A						
		Maximum Reverse Leakage I_{R1} @ V_{R1} (μA)	Stand off Voltage V_{R1} (Volts)	Breakdown Voltage V_{BR1} (Volts) @ I_T1		Maximum Clamping Voltage V_{C1} @ I_{PP1} (V)	Maximum Peak Pulse Current I_{PP1} (A)	Test Current I_T1 (mA)	Maximum Reverse Leakage I_{R2} @ V_{R2} (μA)	Stand off Voltage V_{R2} (Volts)	Breakdown Voltage V_{BR2} (Volts) @ I_T2		Maximum Clamping Voltage V_{C2} @ I_{PP2} (V)	Maximum Peak Pulse Current I_{PP2} (A)	Test Current I_T2 (mA)
				MIN	MAX						MIN	MAX			
TPSMB2616CA	2616	1	26	28.9	31.9	42.1	14.3	1	1	16	17.8	19.7	26	23.1	1

I-V Curve Characteristics

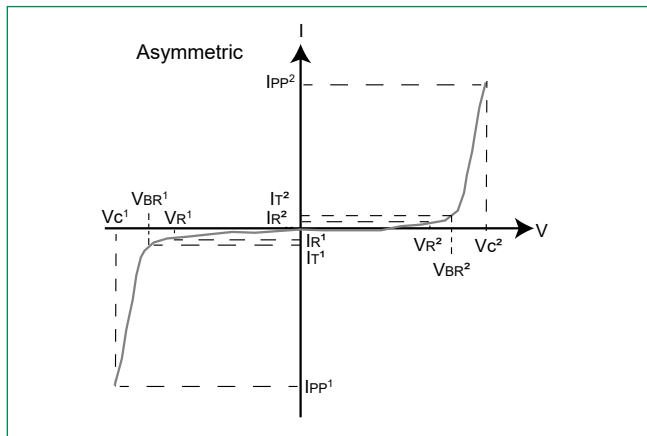

- P_{PPM} Peak Pulse Power Dissipation** ($I_{PP} \times V_C$) – Max power dissipation
- V_{R1}/V_{R2} Stand-off Voltage** – Maximum voltage that can be applied to the TVS without operation
- V_{BR1}/V_{BR2} Breakdown Voltage** – Maximum voltage that flows though the TVS at a specified test current (I_T)
- V_{C1}/V_{C2} Clamping Voltage** – Peak voltage measured across the TVS at a specified I_{ppm} (peak impulse current)
- I_{R1}/I_{R2} Reverse Leakage Current** – Current measured at V_R

Ratings and Characteristic Curves ($T_A=25^\circ\text{C}$ unless otherwise noted)

Figure 1:
TVS Transients Clamping Waveform

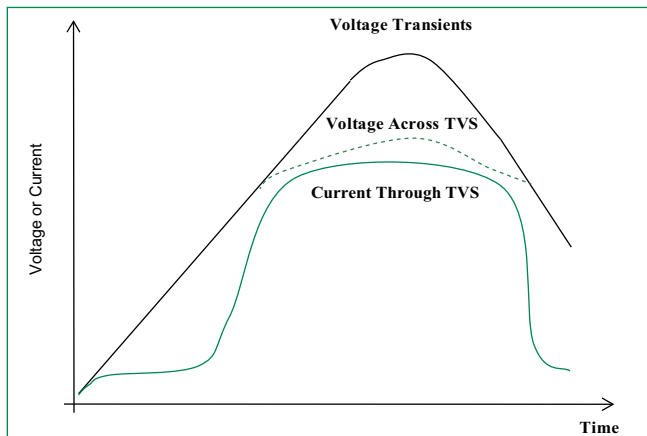
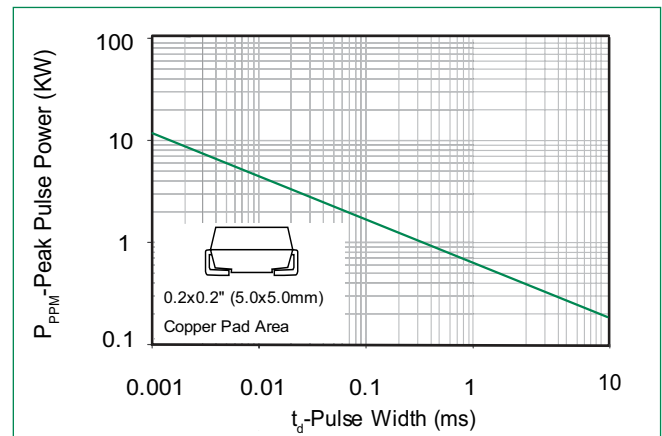

Figure 2:
Peak Pulse Power Rating Curve



TPSMB Asymmetric Series

Surface Mount – 600W

Ratings and Characteristic Curves ($T_A=25^\circ\text{C}$ unless otherwise noted) (Continued)

Figure 3:
Peak Pulse Power Derating Curve

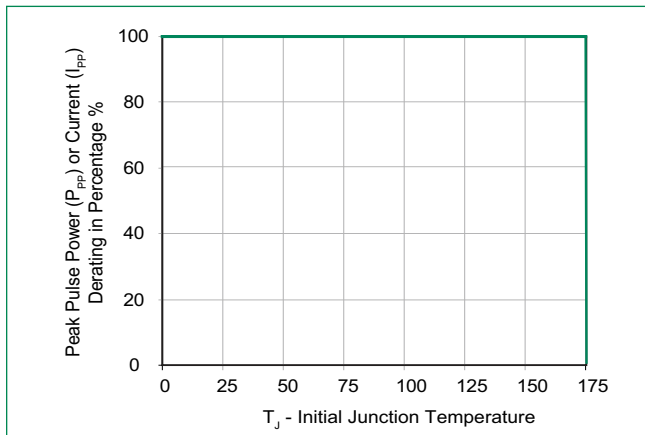
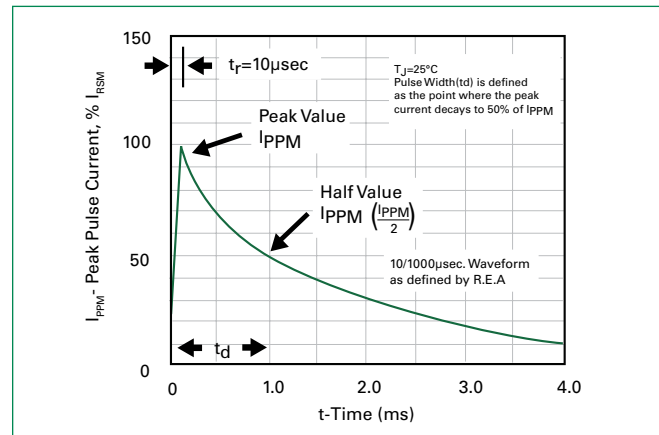
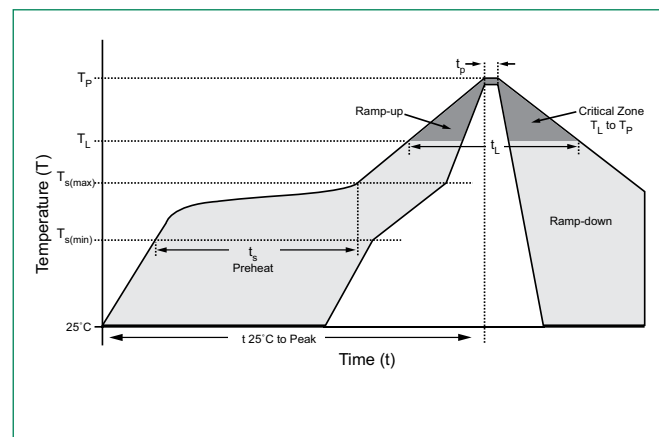

Figure 4:
Pulse Waveform



Soldering Parameters

Reflow Condition		Lead-free assembly
Pre Heat	- Temperature Min ($T_{s(min)}$)	150°C
	- Temperature Max ($T_{s(max)}$)	200°C
	- Time (min to max) (t_s)	60 – 120 secs
Average ramp up rate (Liquidus Temp (T_L) to peak)		3°C/second max
$T_{s(max)}$ to T_L - Ramp-up Rate		3°C/second max
Reflow	- Temperature (T_L) (Liquidus)	217°C
	- Time (min to max) (t_s)	60 – 150 seconds
Peak Temperature (T_p)		260 \pm 0/-5 °C
Time within 5°C of actual peak Temperature (t_p)		30 seconds max
Ramp-down Rate		6°C/second max
Time 25°C to peak Temperature (T_p)		8 minutes max.
Do not exceed		260°C



Physical Specifications

Weight	0.003 ounce, 0.093 grams
Case	JEDEC DO214AA. Molded plastic body over glass passivated junction. Color band denotes cathode for unidirectional components.
Polarity	Matte Tin-plated leads, Solderable per JESD22-B102
Terminal	

Environmental Specifications

High Temp. Storage	JESD22-A103
HTRB	JESD22-A108
Temperature Cycling	JESD22-A104
MSL	JEDEC-J-STD-020, Level 1
H3TRB	JESD22-A101
RSH	JESD22-A111

TPSMB Asymmetric Series

Surface Mount – 600W

Dimensions

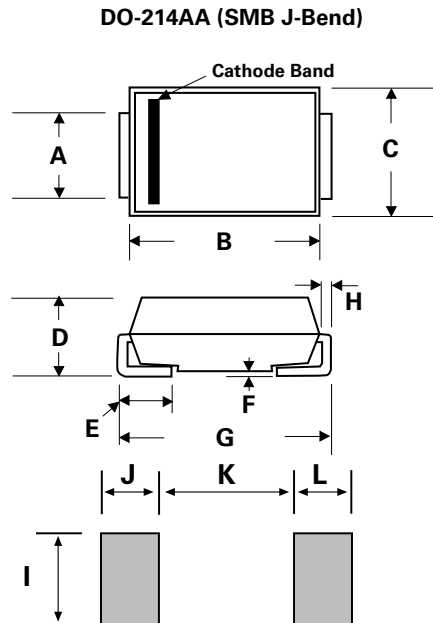

Dimensions	Inches		Millimeters	
	Min	Max	Min	Max
A	0.077	0.086	1.950	2.200
B	0.160	0.180	4.060	4.570
C	0.130	0.155	3.300	3.940
D	0.084	0.096	2.130	2.440
E	0.030	0.060	0.760	1.520
F	-	0.008	-	0.203
G	0.205	0.220	5.210	5.590
H	0.006	0.012	0.152	0.305
I	0.089	-	2.260	-
J	0.085	-	2.160	-
K	-	0.107	-	2.740
L	0.085	-	2.160	-

Part Numbering System

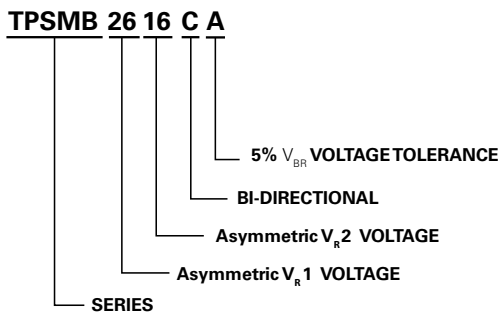

Part Marking System

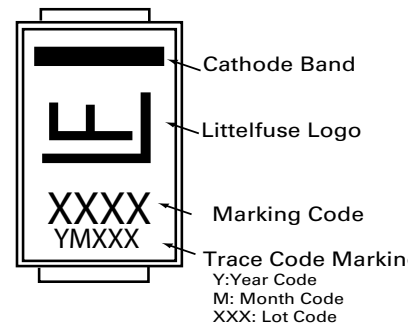

Product Selector & Packaging Option

Part number	Marking Code	Component Package	Quantity	Packaging Option	Packaging Specification
TPSMB2616CA	2616	DO-214AA	3000	Tape & Reel - 12mm tape/13" reel	EIA STD RS-481

TPSMB Asymmetric Series

Surface Mount – 600W

Tape and Reel Specification

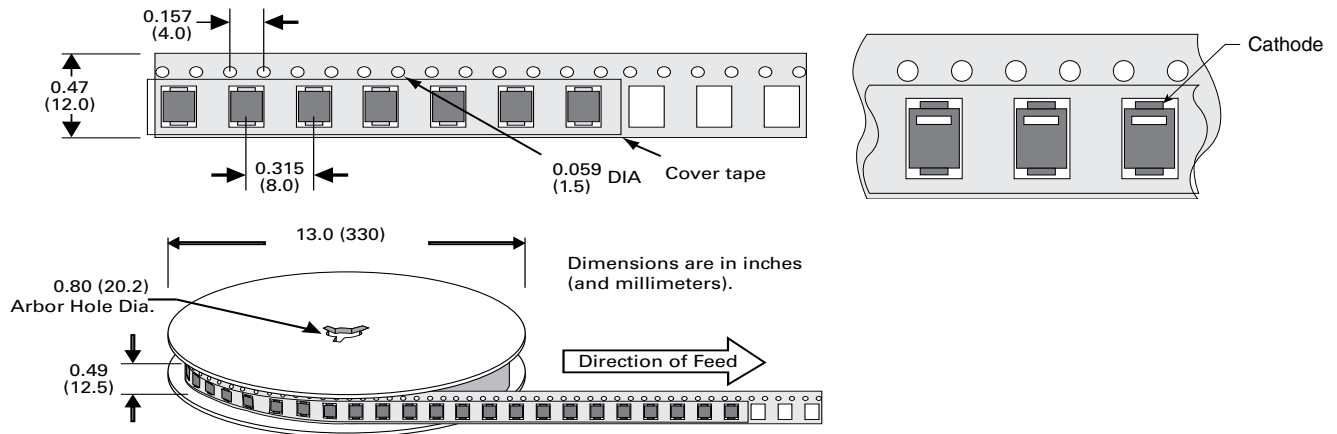

Disclaimer Notice - Information furnished is believed to be accurate and reliable. However, users should independently evaluate the suitability of and test each product selected for their own applications. Littelfuse products are not designed for, and may not be used in, all applications. Read complete Disclaimer Notice at <http://www.littelfuse.com/disclaimer-electronics>.