

# XPT IGBT Module

preliminary

$$V_{CES} = 2 \times 1200V$$

$$I_{C25} = 360A$$

$$V_{CE(sat)} = 1.8V$$

Phase leg + free wheeling Diodes + NTC

Part number

**MIXA225PF1200TSF**

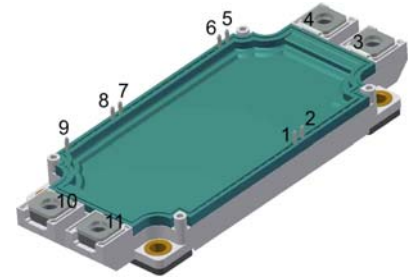

Backside: isolated

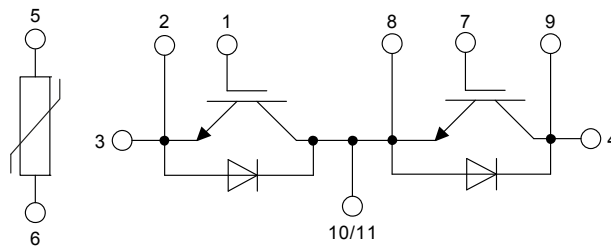

### Features / Advantages:

- High level of integration - only one power semiconductor module required for the whole drive
- Rugged XPT design (Xtreme light Punch Through) results in:
  - short circuit rated for 10  $\mu$ sec.
  - very low gate charge
  - low EMI
  - square RBSOA @ 3x Ic
- Thin wafer technology combined with the XPT design results in a competitive low VCE(sat)
- Temperature sense included
- SONIC™ diode
  - fast and soft reverse recovery
  - low operating forward voltage

### Applications:

- AC motor drives
- Pumps, Fans
- Air-conditioning system
- Inverter and power supplies
- UPS

### Package: SimBus F

- Isolation Voltage: 3000V~
- Industry standard outline
- RoHS compliant
- Soldering pins for PCB mounting
- Height: 17 mm
- Base plate: Copper internally DCB isolated
- Advanced power cycling

IGBT				Ratings			
Symbol	Definition	Conditions	min.	typ.	max.	Unit	
$V_{CES}$	collector emitter voltage	$T_{VJ} = 25^{\circ}\text{C}$			1200	V	
$V_{GES}$	max. DC gate voltage				$\pm 20$	V	
$V_{GEM}$	max. transient gate emitter voltage				$\pm 30$	V	
$I_{C25}$	collector current	$T_C = 25^{\circ}\text{C}$			360	A	
$I_{C80}$		$T_C = 80^{\circ}\text{C}$			250	A	
$P_{tot}$	total power dissipation	$T_C = 25^{\circ}\text{C}$			1100	W	
$V_{CE(sat)}$	collector emitter saturation voltage	$I_C = 225\text{A}; V_{GE} = 15\text{V}$		1.8	2.1	V	
				2.1		V	
$V_{GE(th)}$	gate emitter threshold voltage	$I_C = 9\text{mA}; V_{GE} = V_{CE}$	5.4	5.9	6.5	V	
$I_{CES}$	collector emitter leakage current	$V_{CE} = V_{CES}; V_{GE} = 0\text{V}$			0.3	mA	
				0.3		mA	
$I_{GES}$	gate emitter leakage current	$V_{GE} = \pm 20\text{V}$			1.5	$\mu\text{A}$	
$Q_{G(on)}$	total gate charge	$V_{CE} = 600\text{V}; V_{GE} = 15\text{V}; I_C = 225\text{A}$		690		nC	
$t_{d(on)}$	turn-on delay time	inductive load $V_{CE} = 600\text{V}; I_C = 225\text{A}$ $V_{GE} = \pm 15\text{V}; R_G = 3.3\ \Omega$		60		ns	
$t_r$	current rise time		$T_{VJ} = 125^{\circ}\text{C}$	70		ns	
$t_{d(off)}$	turn-off delay time		280		ns		
$t_f$	current fall time		310		ns		
$E_{on}$	turn-on energy per pulse		20		mJ		
$E_{off}$	turn-off energy per pulse		27		mJ		
<b>RBSOA</b>	reverse bias safe operating area	$V_{GE} = \pm 15\text{V}; R_G = 3.3\ \Omega$					
$I_{CM}$		$V_{CEmax} = 1200\text{V}$			500	A	
<b>SCSOA</b>	short circuit safe operating area	$V_{CEmax} = 1200\text{V}$					
$t_{sc}$	short circuit duration	$V_{CE} = 900\text{V}; V_{GE} = \pm 15\text{V}$			10	$\mu\text{s}$	
$I_{sc}$	short circuit current	$R_G = 3.3\ \Omega; \text{non-repetitive}$		900		A	
$R_{thJC}$	thermal resistance junction to case				0.115	K/W	
$R_{thCH}$	thermal resistance case to heatsink				0.05	K/W	
<b>Diode</b>							
$V_{RRM}$	max. repetitive reverse voltage	$T_{VJ} = 25^{\circ}\text{C}$			1200	V	
$I_{F25}$	forward current	$T_C = 25^{\circ}\text{C}$			265	A	
$I_{F80}$		$T_C = 80^{\circ}\text{C}$			185	A	
$V_F$	forward voltage	$I_F = 225\text{A}$			2.10	V	
				1.70		V	
$I_R$	reverse current	$V_R = V_{RRM}$			*	mA	
	* not applicable, see Ices value above				*	mA	
$Q_{rr}$	reverse recovery charge	$V_R = 600\text{V}$ $-di_F/dt = 3300\text{A}/\mu\text{s}$ $I_F = 225\text{A}; V_{GE} = 0\text{V}$		32		$\mu\text{C}$	
$I_{RM}$	max. reverse recovery current		$T_{VJ} = 125^{\circ}\text{C}$	250		A	
$t_{rr}$	reverse recovery time		340		ns		
$E_{rec}$	reverse recovery energy		11.7		mJ		
$R_{thJC}$	thermal resistance junction to case				0.145	K/W	
$R_{thCH}$	thermal resistance case to heatsink				0.05	K/W	

Package SimBus F			Ratings			
Symbol	Definition	Conditions	min.	typ.	max.	Unit
$I_{RMS}$	RMS current	per terminal				A
$T_{stg}$	storage temperature		-40		125	°C
$T_{VJ}$	virtual junction temperature		-40		150	°C
<b>Weight</b>				350		g
$M_D$	mounting torque		3		6	Nm
$M_T$	terminal torque		3		6	Nm
$d_{Spp/App}$	creepage distance on surface   striking distance through air	terminal to terminal	12.7			mm
$d_{Spb/Apb}$		terminal to backside	10.0			mm
$V_{ISOL}$	isolation voltage	t = 1 second t = 1 minute 50/60 Hz, RMS; $I_{ISOL} \leq 1$ mA	3000 2500			V V
$R_{pin-chip}$	resistance pin to chip	$V = V_{CEsat} + 2 \cdot R \cdot I_C$ resp. $V = V_F + 2 \cdot R \cdot I_F$		0.65		mΩ

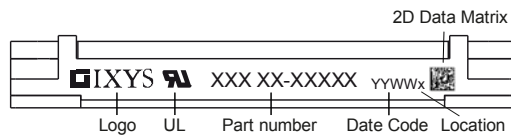

### Part number

- M = Module
- I = IGBT
- X = XPT IGBT
- A = Gen 1 / std
- 225 = Current Rating [A]
- PF = Phase leg + free wheeling Diodes
- 1200 = Reverse Voltage [V]
- T = Thermistor \ Temperature sensor
- SF = SimBus F

Ordering	Part Number	Marking on Product	Delivery Mode	Quantity	Code No.
Standard	MIXA225PF1200TSF	MIXA225PF1200TSF	Box	3	512257

### Temperature Sensor NTC

Symbol	Definition	Conditions	min.	typ.	max.	Unit
$R_{25}$	resistance	$T_{VJ} = 25^\circ$	4.75	5	5.25	kΩ
$B_{25/50}$	temperature coefficient			3375		K

### Equivalent Circuits for Simulation

\* on die level

$T_{VJ} = 150^\circ\text{C}$

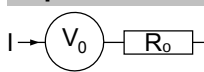

		IGBT	Diode	Unit
$V_{0\ max}$	threshold voltage	1.1	1.19	V
$R_{0\ max}$	slope resistance *	6	8.9	mΩ

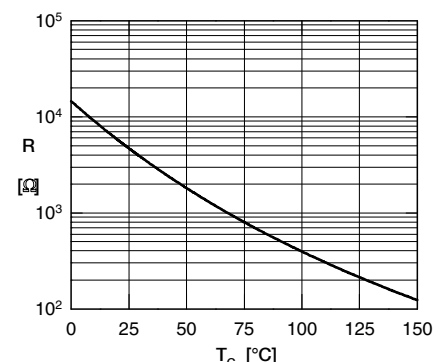

Typ. NTC resistance vs. temperature

Outlines SimBus F

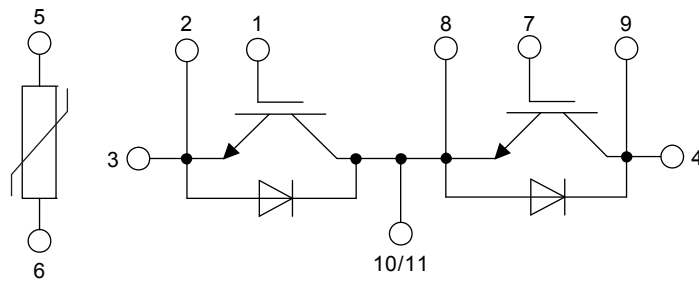
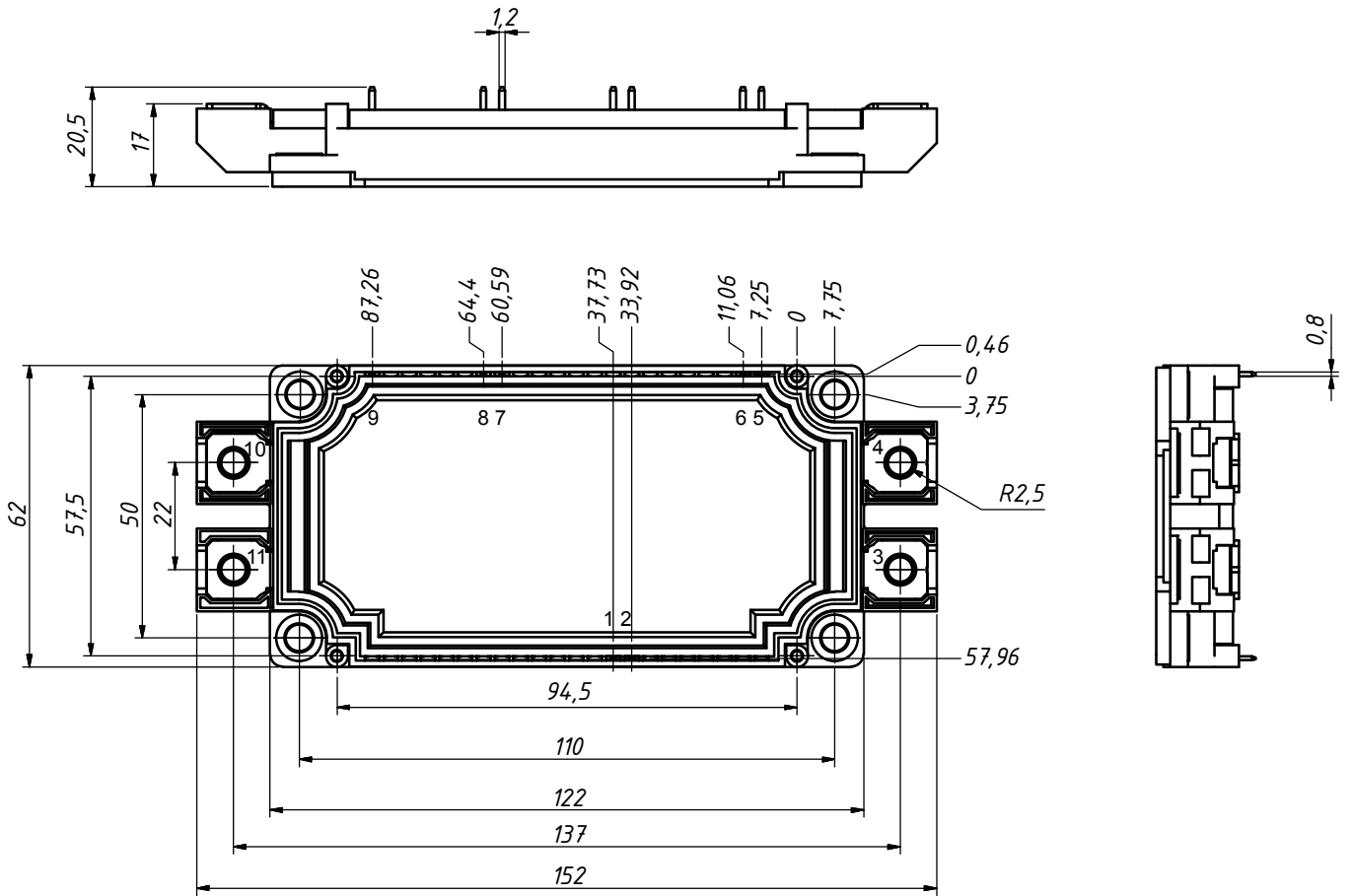

## IGBT

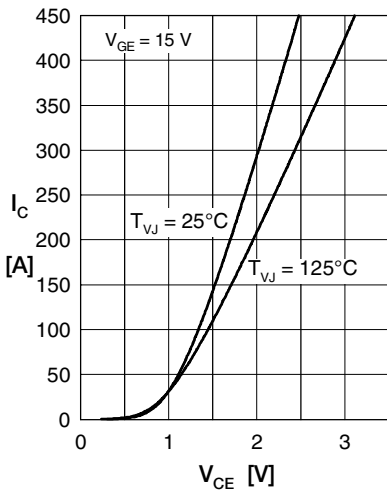

Fig. 1 Typ. output characteristics

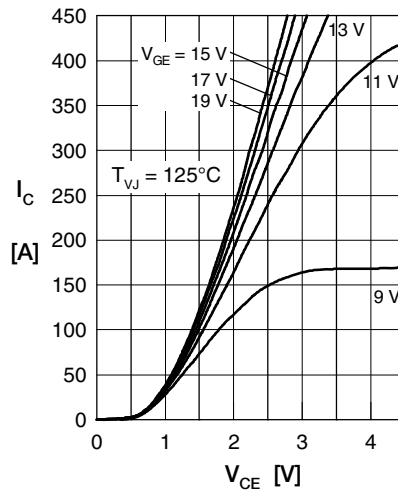

Fig. 2 Typ. output characteristics

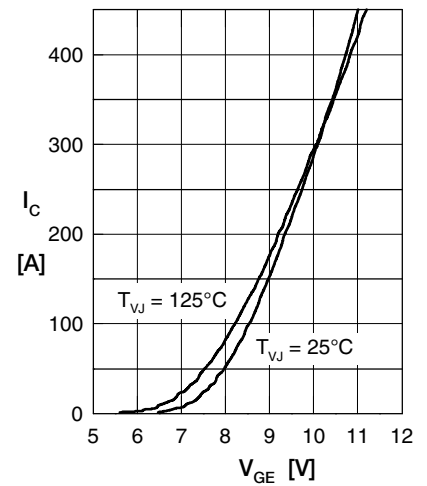

Fig. 3 Typ. transfer characteristics

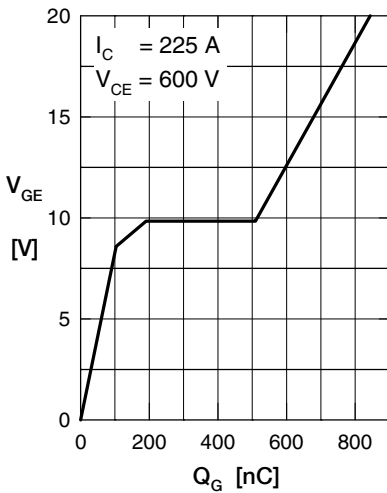

Fig. 4 Typ. turn-on gate charge

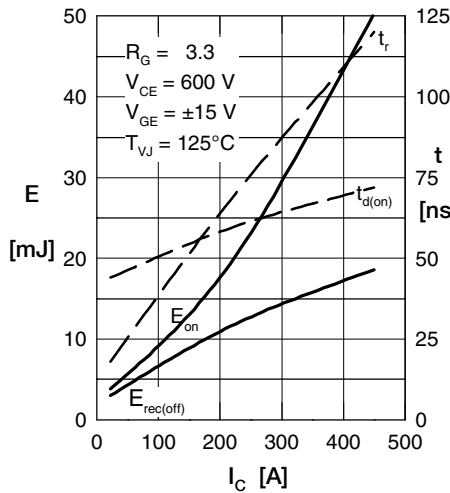

Fig. 5 Typ. switching energy versus collector current

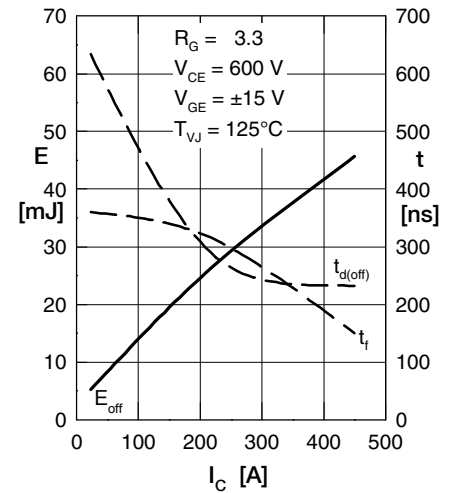

Fig. 6 Typ. switching energy versus collector current

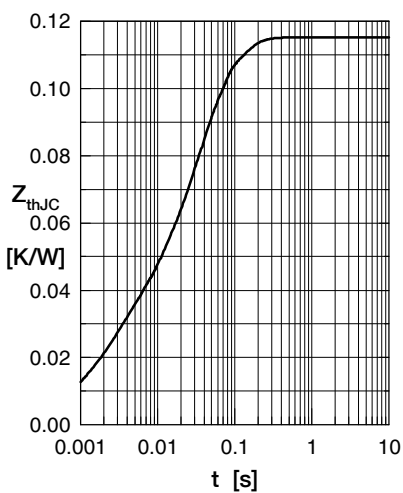

Fig. 7 Typical transient thermal impedance junction to case

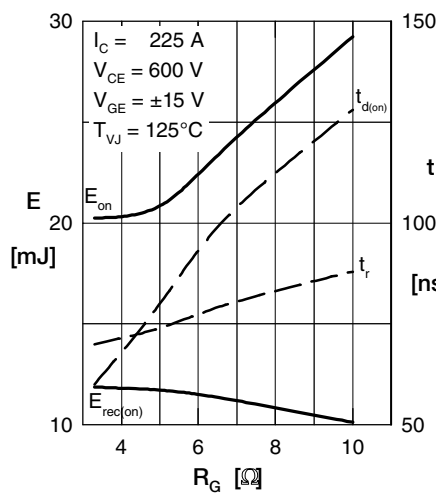

Fig. 8 Typ. switching energy versus gate resistance

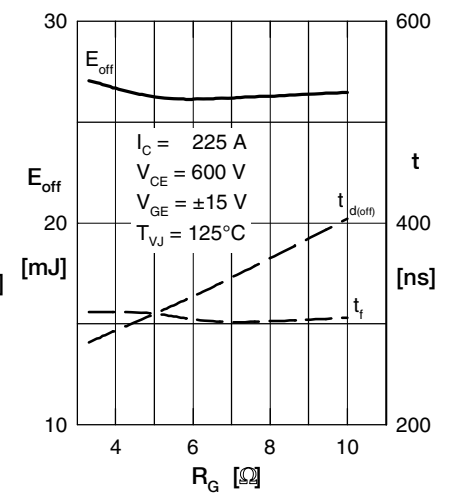

Fig. 9 Typ. switching energy versus gate resistance

**Diode**

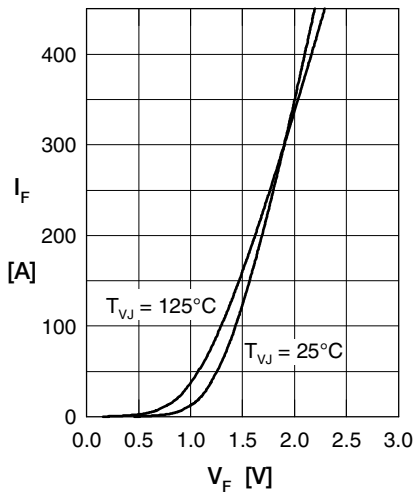

Fig. 1 Typ. forward current versus  $V_F$

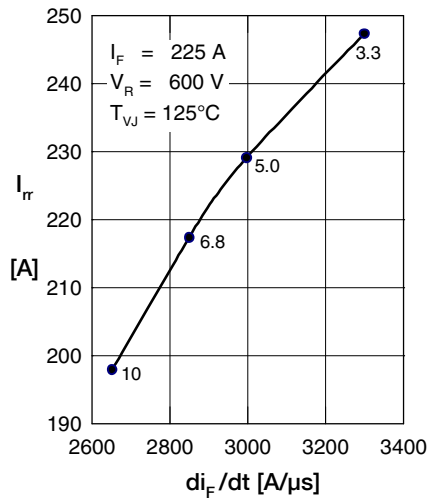

Fig. 2 Typ. reverse recovery characteristics

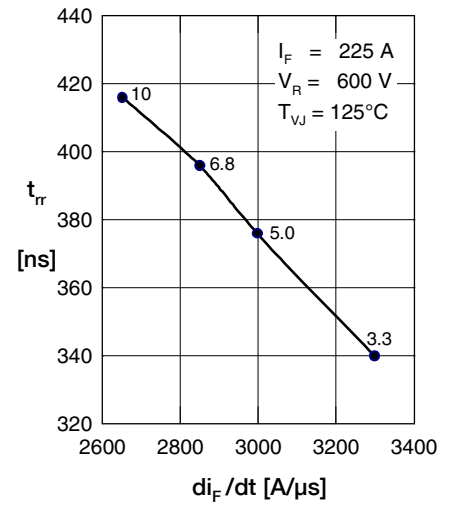

Fig. 3 Typ. reverse recovery characteristics

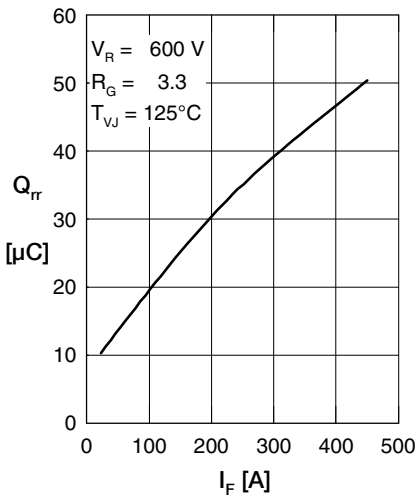

Fig. 4 Typ. reverse recovery characteristics

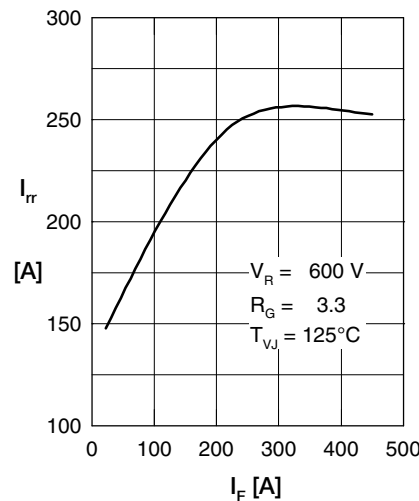

Fig. 5 Typ. reverse recovery characteristics

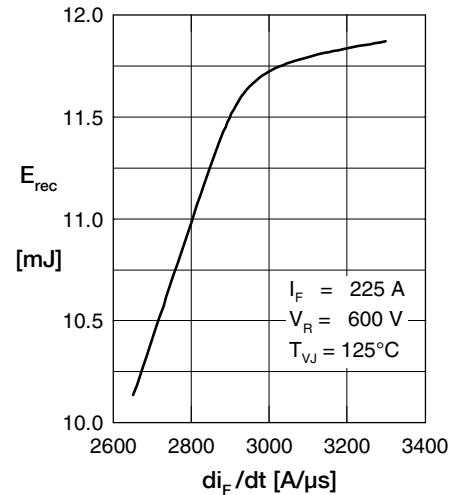

Fig. 6 Typ. recovery energy  $E_{rec}$  versus  $di_F/dt$

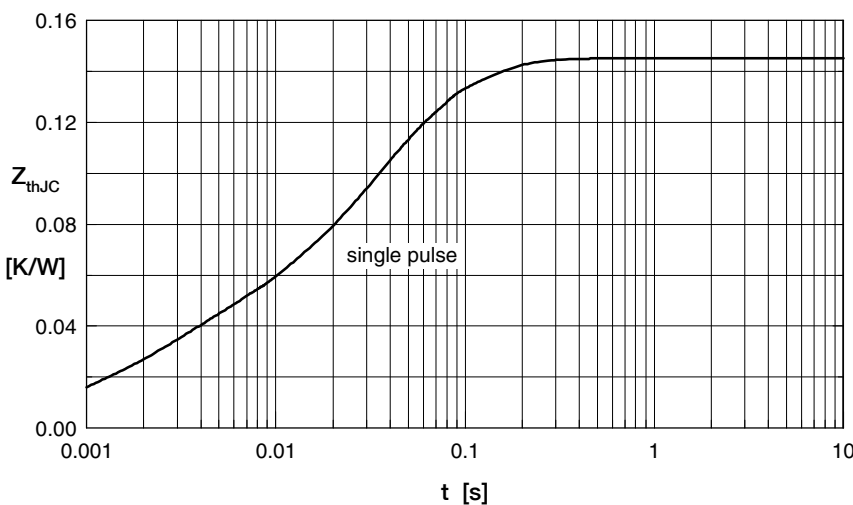

Fig. 7 Typ. transient thermal impedance junction to case