

XPT IGBT Module

$$V_{CES} = 2 \times 1200V$$

$$I_{C25} = 650A$$

$$V_{CE(sat)} = 1.8V$$

Phase leg + free wheeling Diodes + NTC

Part number

MIXA450PF1200TSF

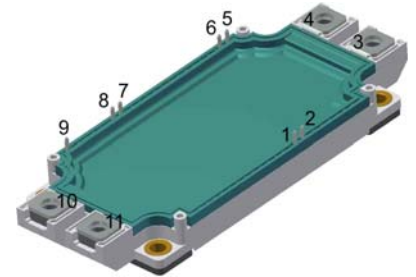

Backside: isolated

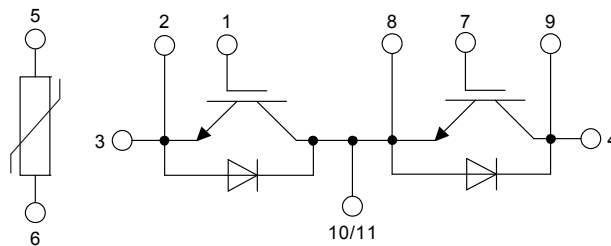
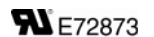

Features / Advantages:

- High level of integration - only one power semiconductor module required for the whole drive
- Rugged XPT design (Xtreme light Punch Through) results in:
 - short circuit rated for 10 μ sec.
 - very low gate charge
 - low EMI
 - square RBSOA @ 3x I_c
- Thin wafer technology combined with the XPT design results in a competitive low $V_{CE(sat)}$
- Temperature sense included
- SONIC™ diode
 - fast and soft reverse recovery
 - low operating forward voltage

Applications:

- AC motor drives
- Pumps, Fans
- Air-conditioning system
- Inverter and power supplies
- UPS

Package: SimBus F

- Isolation Voltage: 3000V~
- Industry standard outline
- RoHS compliant
- Soldering pins for PCB mounting
- Height: 17 mm
- Base plate: Copper internally DCB isolated
- Advanced power cycling

IGBT				Ratings			
Symbol	Definition	Conditions	min.	typ.	max.	Unit	
V_{CES}	collector emitter voltage	$T_{VJ} = 25^{\circ}C$			1200	V	
V_{GES}	max. DC gate voltage				± 20	V	
V_{GEM}	max. transient gate emitter voltage				± 30	V	
I_{C25}	collector current	$T_C = 25^{\circ}C$			650	A	
I_{C80}		$T_C = 80^{\circ}C$			450	A	
P_{tot}	total power dissipation	$T_C = 25^{\circ}C$			2100	W	
$V_{CE(sat)}$	collector emitter saturation voltage	$I_C = 450A; V_{GE} = 15V$		1.8	2.15	V	
				2.15		V	
$V_{GE(th)}$	gate emitter threshold voltage	$I_C = 18mA; V_{GE} = V_{CE}$	5.4	5.9	6.5	V	
I_{CES}	collector emitter leakage current	$V_{CE} = V_{CES}; V_{GE} = 0V$			1	mA	
				6		mA	
I_{GES}	gate emitter leakage current	$V_{GE} = \pm 20V$			1.5	μA	
$Q_{G(on)}$	total gate charge	$V_{CE} = 600V; V_{GE} = 15V; I_C = 450A$		1400		nC	
$t_{d(on)}$	turn-on delay time	inductive load $V_{CE} = 600V; I_C = 450A$ $V_{GE} = \pm 15V; R_G = 1.6\Omega$		85		ns	
t_r	current rise time		$T_{VJ} = 125^{\circ}C$		80		ns
$t_{d(off)}$	turn-off delay time				310		ns
t_f	current fall time				360		ns
E_{on}	turn-on energy per pulse				22		mJ
E_{off}	turn-off energy per pulse				68		mJ
RBSOA	reverse bias safe operating area	$V_{GE} = \pm 15V; R_G = 1.6\Omega$					
I_{CM}		$V_{CEmax} = 1200V$			900	A	
SCSOA	short circuit safe operating area	$V_{CEmax} = 1200V$					
t_{sc}	short circuit duration	$V_{CE} = 900V; V_{GE} = \pm 15V$			10	μs	
I_{sc}	short circuit current	$R_G = 1.6\Omega; \text{non-repetitive}$		1900		A	
R_{thJC}	thermal resistance junction to case				0.06	K/W	
R_{thCH}	thermal resistance case to heatsink			0.03		K/W	
Diode							
V_{RRM}	max. repetitive reverse voltage	$T_{VJ} = 25^{\circ}C$			1200	V	
I_{F25}	forward current	$T_C = 25^{\circ}C$			380	A	
I_{F80}		$T_C = 80^{\circ}C$			265	A	
V_F	forward voltage	$I_F = 450A$			2.30	V	
				2.00		V	
I_R	reverse current	$V_R = V_{RRM}$			*	mA	
	* not applicable, see Ices value above			*		mA	
Q_{rr}	reverse recovery charge	$V_R = 600V$ $-di_F/dt = 5400A/\mu s$ $I_F = 450A; V_{GE} = 0V$		62		μC	
I_{RM}	max. reverse recovery current		$T_{VJ} = 125^{\circ}C$		425		A
t_{rr}	reverse recovery time				360		ns
E_{rec}	reverse recovery energy				26		mJ
R_{thJC}	thermal resistance junction to case				0.095	K/W	
R_{thCH}	thermal resistance case to heatsink			0.04		K/W	

Package SimBus F			Ratings			
Symbol	Definition	Conditions	min.	typ.	max.	Unit
I_{RMS}	RMS current	per terminal				A
T_{stg}	storage temperature		-40		125	°C
T_{VJ}	virtual junction temperature		-40		150	°C
Weight				350		g
M_D	mounting torque		3		6	Nm
M_T	terminal torque		3		6	Nm
$d_{Spp/App}$	creepage distance on surface striking distance through air	terminal to terminal	12.7			mm
$d_{Spb/Appb}$		terminal to backside	10.0			mm
V_{ISOL}	isolation voltage	t = 1 second t = 1 minute 50/60 Hz, RMS; $I_{ISOL} \leq 1$ mA	3000 2500			V V
$R_{pin-chip}$	resistance pin to chip	$V = V_{CEsat} + 2 \cdot R \cdot I_C$ resp. $V = V_F + 2 \cdot R \cdot I_F$		0.65		mΩ

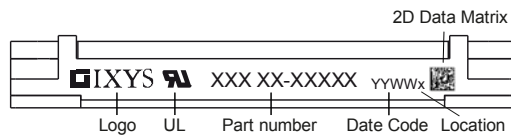

Part number

- M = Module
- I = IGBT
- X = XPT IGBT
- A = Gen 1 / std
- 450 = Current Rating [A]
- PF = Phase leg + free wheeling Diodes
- 1200 = Reverse Voltage [V]
- T = Thermistor \ Temperature sensor
- SF = SimBus F

Ordering	Part Number	Marking on Product	Delivery Mode	Quantity	Code No.
Standard	MIXA450PF1200TSF	MIXA450PF1200TSF	Box	3	511202

Temperature Sensor NTC

Symbol	Definition	Conditions	min.	typ.	max.	Unit
R_{25}	resistance	$T_{VJ} = 25^\circ$	4.75	5	5.25	kΩ
$B_{25/50}$	temperature coefficient			3375		K

Equivalent Circuits for Simulation

* on die level

$T_{VJ} = 150^\circ\text{C}$

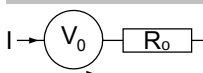

		IGBT	Diode	
$V_{0\ max}$	threshold voltage	1.1	1.25	V
$R_{0\ max}$	slope resistance *	3.1	1.9	mΩ

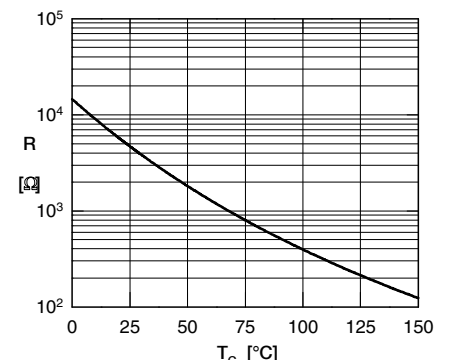

Typ. NTC resistance vs. temperature

Outlines SimBus F

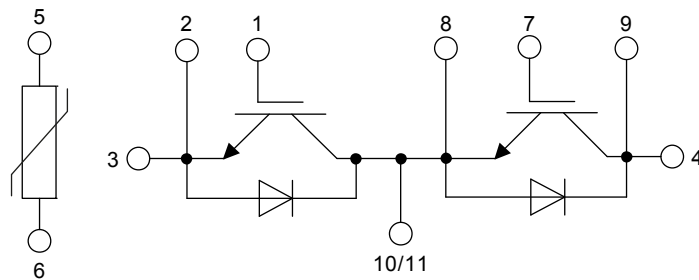
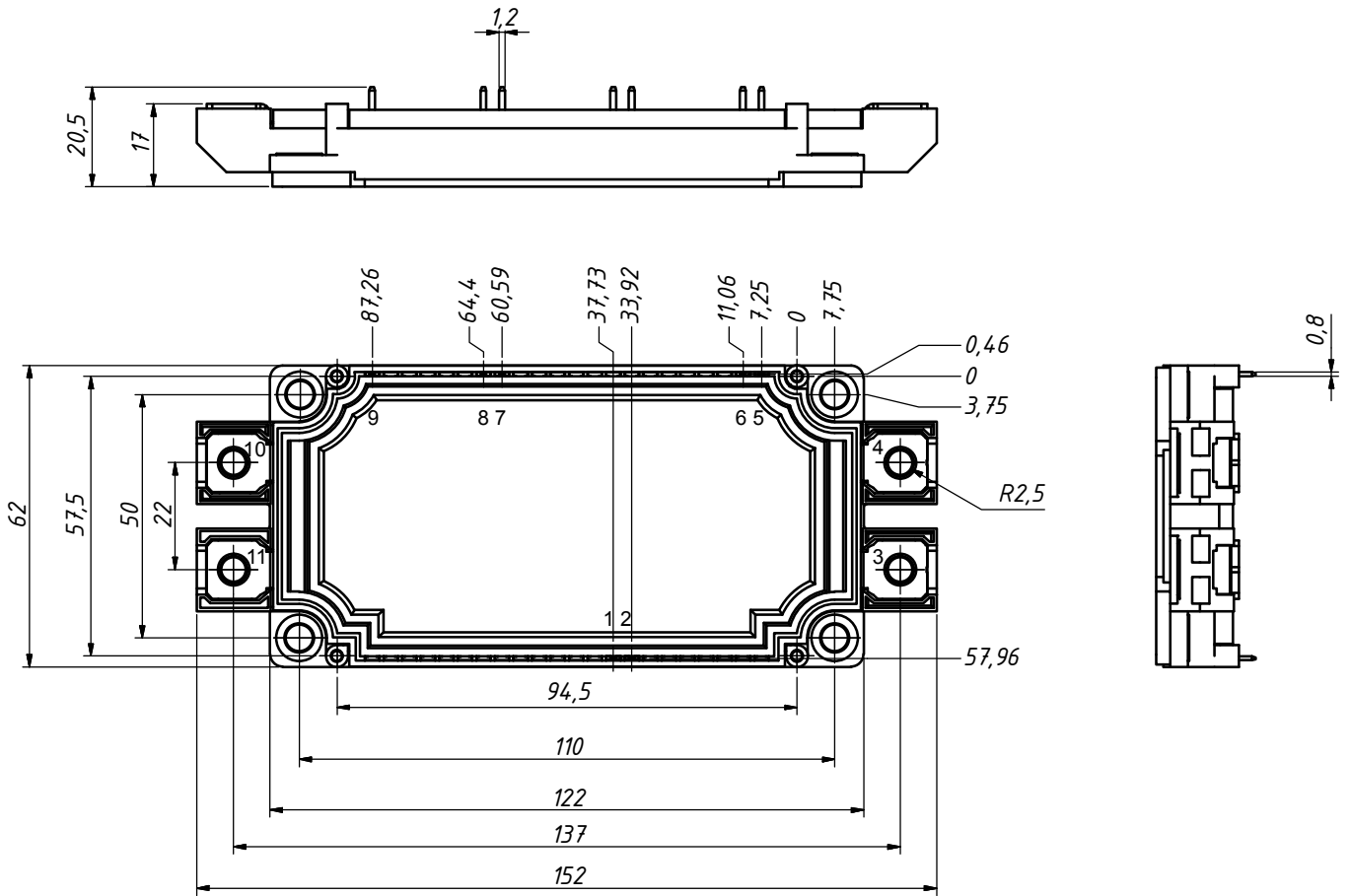

IGBT

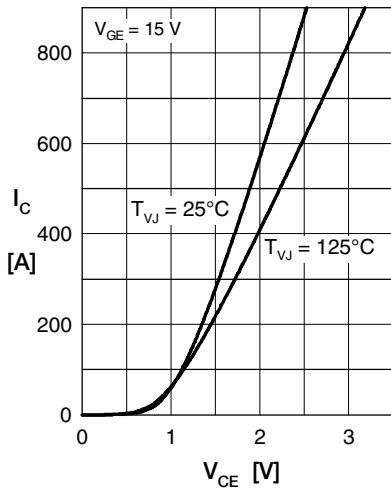

Fig. 1 Typ. output characteristics

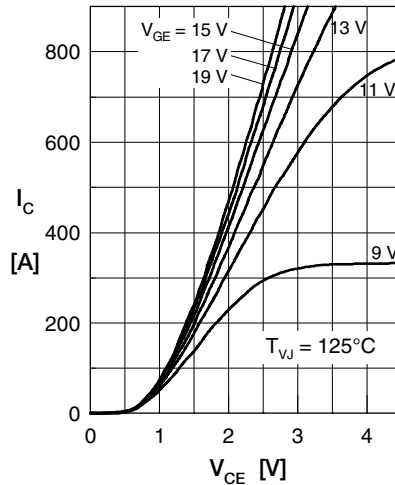

Fig. 2 Typ. output characteristics

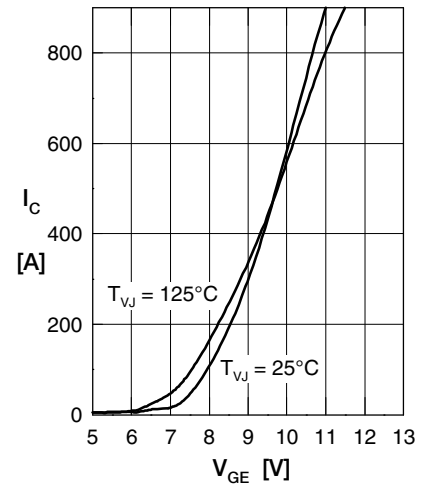

Fig. 3 Typ. transfer characteristics

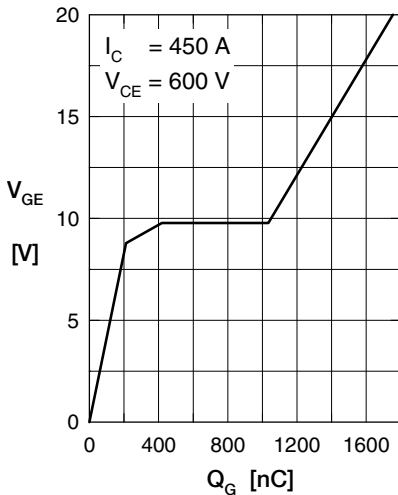

Fig. 4 Typ. turn-on gate charge

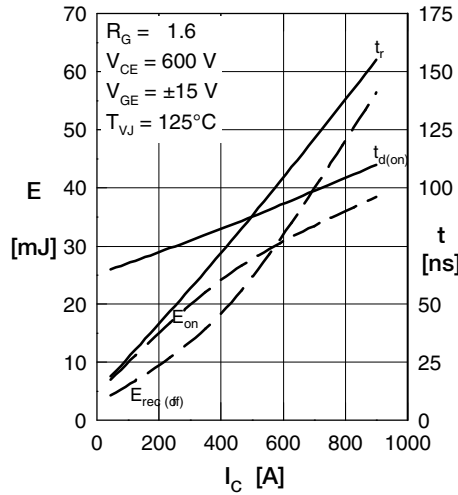

Fig. 5 Typ. turn-on energy & switching times vs. collector current, inductive switching

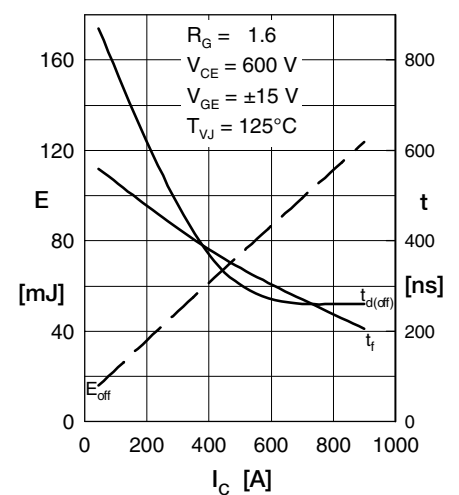

Fig. 6 Typ. switching energy versus gate resistance

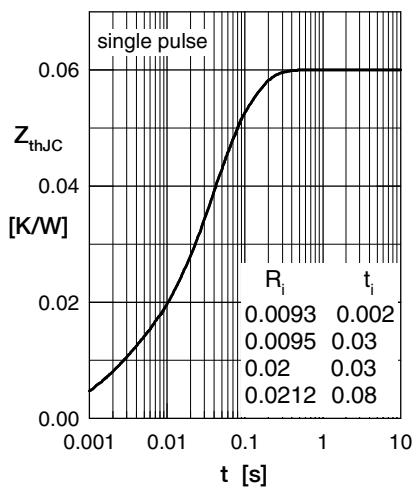

Fig. 7 Typ. trans. therm. impedance

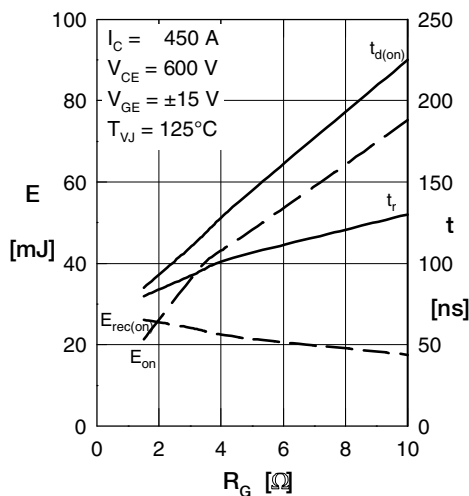

Fig. 8 Typ. turn-on energy, switching times vs. gate resistor, inductive switching

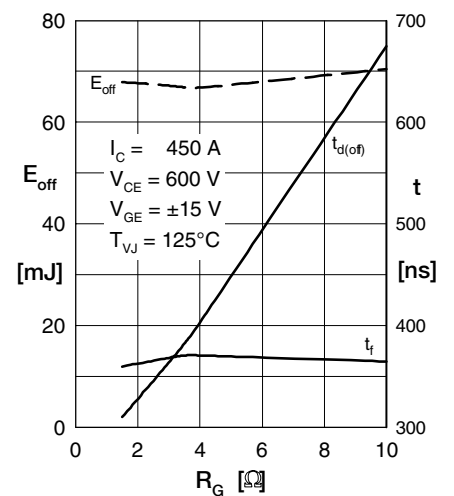

Fig. 9 Typ. turn-off energy, switching times vs. gate resistor, inductive switching

Diode

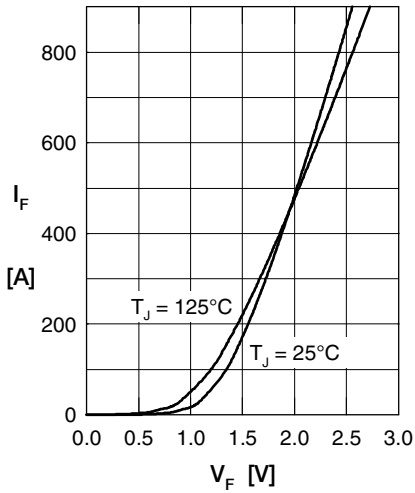

Fig. 1 Typ. Forward current versus V_F

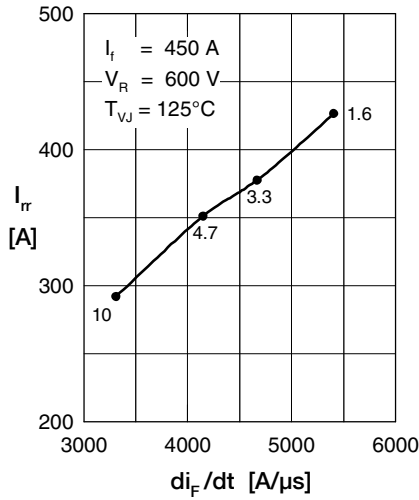

Fig. 2 Typ. reverse recovery characteristics

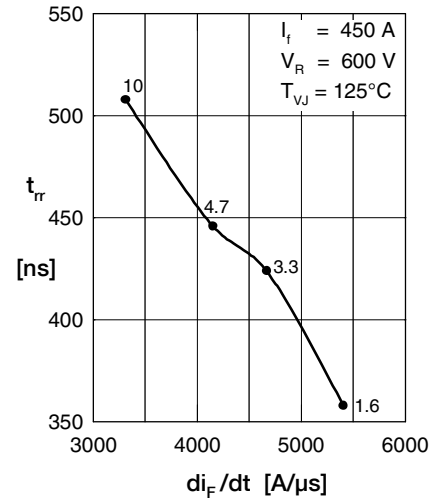

Fig. 3 Typ. reverse recovery characteristics

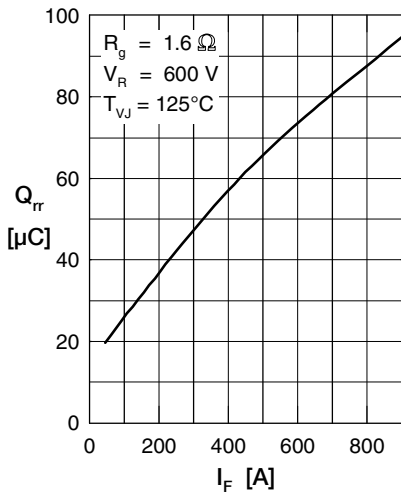

Fig. 4 Typ. reverse recovery characteristics

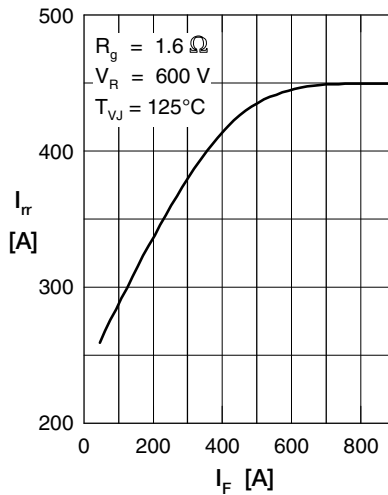

Fig. 5 Typ. reverse recovery characteristics

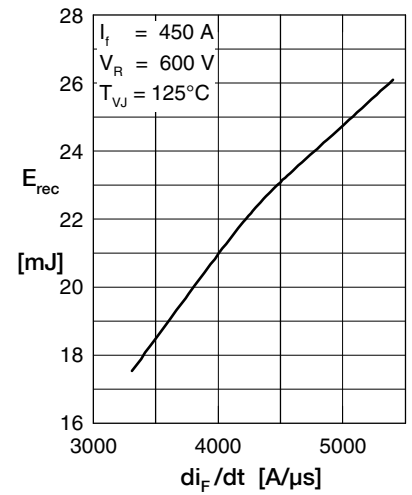

Fig. 6 Typ. recovery energy E_{rec} versus $-di/dt$

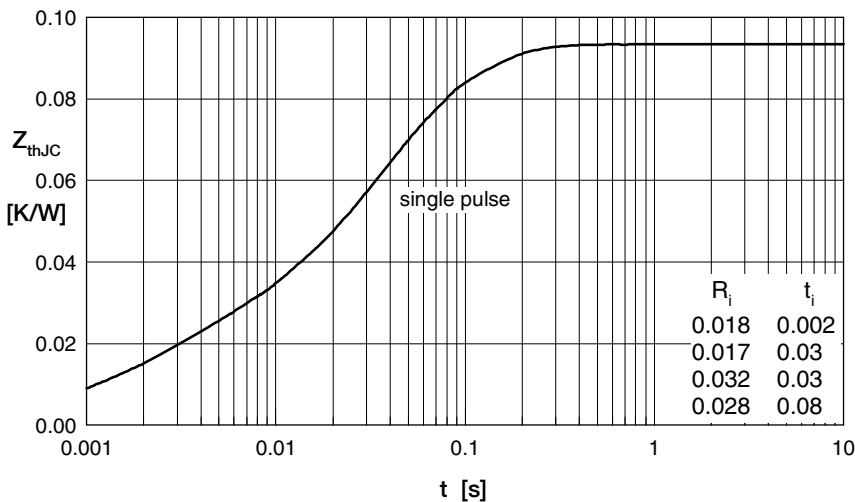

Fig. 7 Typ. transient thermal impedance junction to case