

PART NUMBER	UPC CODE
LS7R03202PS00L	07945829342

REVISION		
REV	DATE	DESCRIPTION
A	6/15/21	523719GCP - RELEASE PER EM3236 MRY

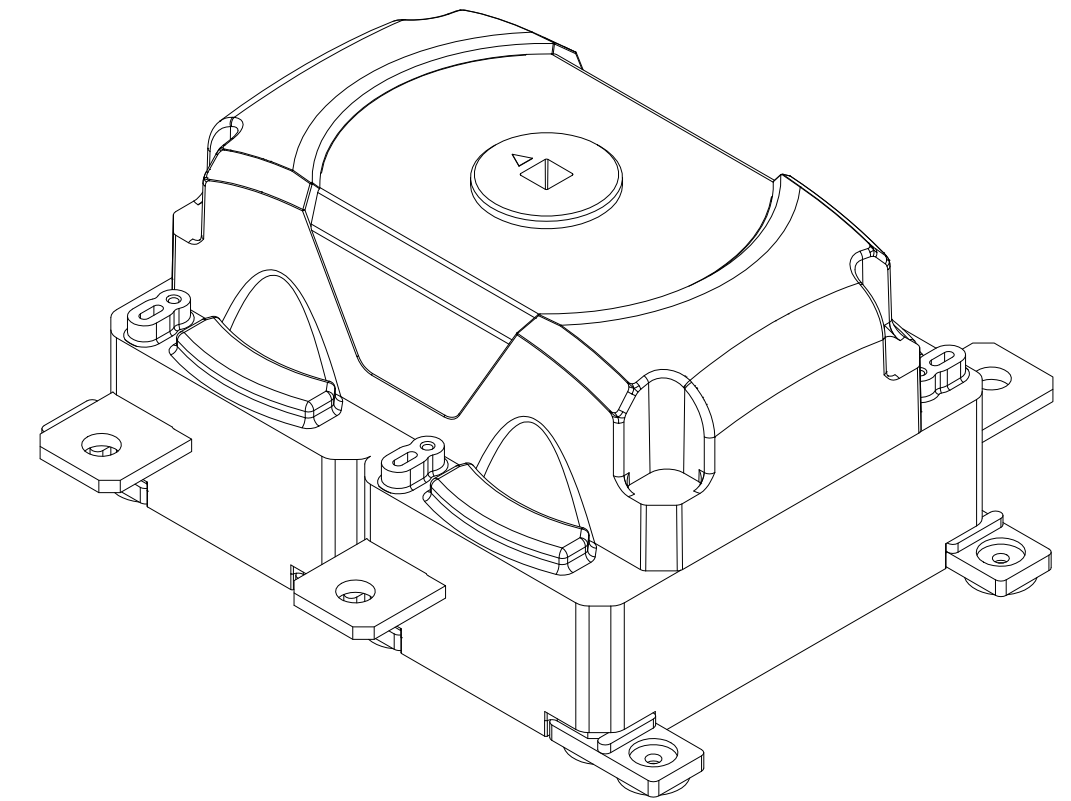

PRODUCT MARKING

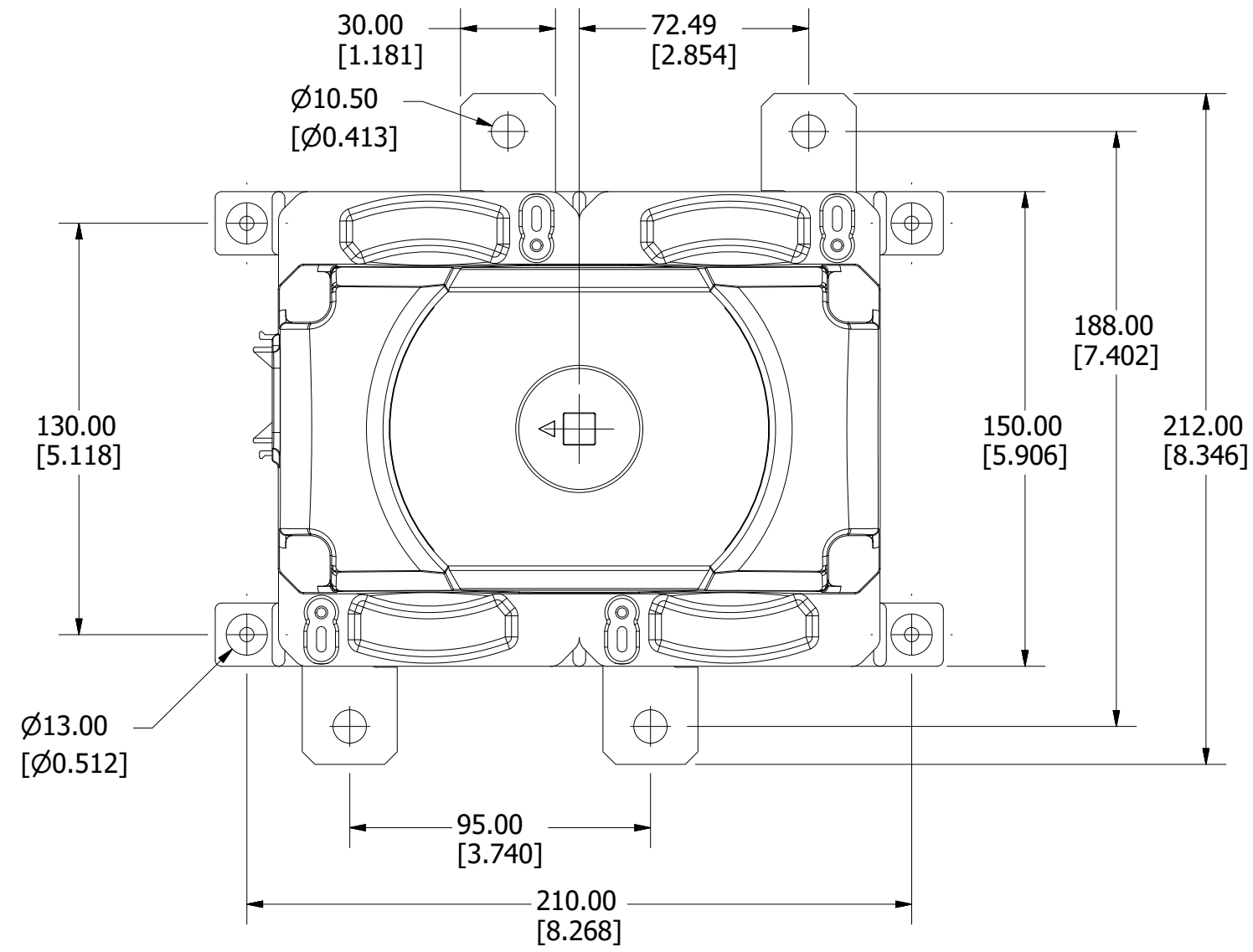
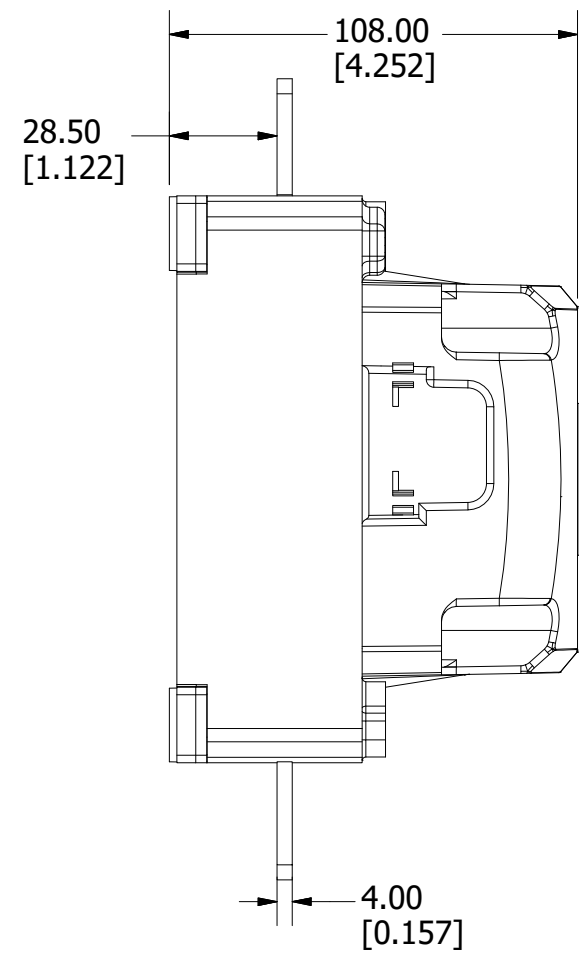
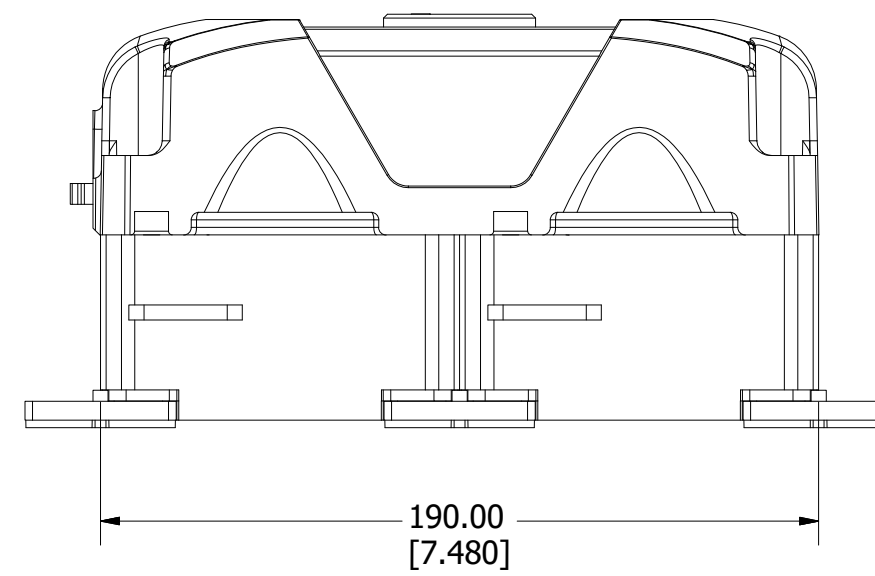

<S>	CRITICAL CHARACTERISTIC FOR PART SAFETY/COMPLIANCE		
●	DENOTES CRITICAL CHARACTERISTICS.		
CPK	DENOTES CPK DIMENSIONS, -MINIMUM CPK VALUE		
ST	DENOTES A CHARACTERISTIC THAT PROVIDES AN INDICATION OF PROCESS PERFORMANCE. PROCEDURE FOR MEASUREMENT AND TRACKING TO BE DEFINED IN LITTELFUSE INSPECTION INSTRUCTIONS.		
CP	DENOTES CP DIMENSIONS, -MINIMUM CP VALUE MUST BE WITHIN THE DIMENSIONAL LIMITATIONS SHOWN ON DRAWING AND INITIALLY LOCATED TO ALLOW FOR MAXIMUM TOOL LIFE.		
MATL SPEC		FINISH	
DRW myork	DATE 5/13/2021	SCALE NTS	FINISH GOOD WT GRAMS/PIECE
UNLESS OTHERWISE SPECIFIED, DIMENSIONS ARE IN MILLIMETERS, DIMENSIONS IN BRACKETS [] ARE INCHES DIMENSIONING AND DO NOT INCLUDE PLATING. TOLERANCING TO BE INTERPRETED IN ACCORDANCE WITH ANSI Y14.5M-1994			
3RD ANGLE PROJECTION			
TITLE DISCONNECT SWITCH 320A 1500VDC 2 POLE OUTLINE			
Littelfuse® CHICAGO, ILLINOIS 60631		REVISION A	DRWG NO. OL-LS7R03202PS00L SHEET 1 OF 1