

# DSA30C200PB

## 200 V, 30 A Schottky Rectifier Diode

RoHS

Pb

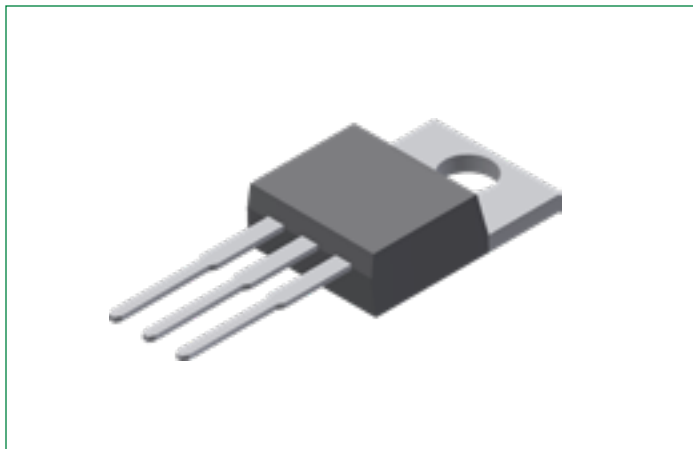

### Features:

- Very low  $V_F$
- Extremely low switching losses
- Low  $I_{RM}$  values
- Improved thermal behavior
- High reliability circuit operation
- Low voltage peaks for reduced protection circuits
- Low noise switching
- Terminals finish: 100% Pure Tin
- This is a Pb-free device
- Epoxy meets UL 94V-0

### Pinout Diagram (TO-220-3L AB)

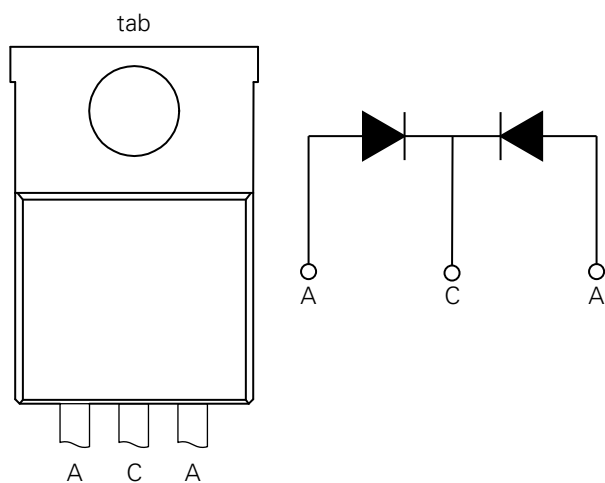

**C:** Cathode; **A:** Anode; **tab:** Cathode

### Applications:

- Rectifiers in Switch Mode Power Supplies (SMPS)
- Free wheeling diode in low voltage converters

### Product Summary

Characteristic	Value	Unit
$V_{RRM}$	200	V
$I_{FAV}$	2 x 15	A
$V_F$	0.78	V

**Maximum Ratings** ( $T_A = 25^\circ\text{C}$  unless otherwise specified)

Symbol	Characteristics	Condition	Max.	Units
$V_{RRM}$	Peak Repetitive Reverse Voltage	-	200	V
$V_{RWM}$	Working Peak Reverse Voltage			
$V_R$	DC Blocking Voltage			
$I_{FAV}$	Average Rectified Forward Current	50% duty cycle @ $T_C = 155^\circ\text{C}$ , rectangular wave form	15 (Per Leg) 30 (Per Device)	A
$I_{FSM}$	Peak One Cycle Non-Repetitive Surge Current (Per Leg)	10 ms, Half Sine pulse, $T_{VJ} = 25^\circ\text{C}$	300	A
$P_{tot}$	Total power dissipation	$T_C = 25^\circ\text{C}$	85	W

**Electrical Characteristics** ( $T_A = 25^\circ\text{C}$  unless otherwise specified)

Symbol	Characteristics	Conditions	Typ.	Max.	Units
$V_{F1}$	Forward Voltage Drop (Per Leg) <sup>1</sup>	@ 15 A, Pulse, $T_{VJ} = 25^\circ\text{C}$	-	0.94	V
$V_{F2}$		@ 15 A, Pulse, $T_{VJ} = 125^\circ\text{C}$	-	0.78	V
$I_{R1}$	Reverse Current (Per Leg) <sup>1</sup>	@ $V_R = \text{rated } V_R, T_{VJ} = 25^\circ\text{C}$	-	250	$\mu\text{A}$
$I_{R2}$		@ $V_R = \text{rated } V_R, T_{VJ} = 125^\circ\text{C}$	-	2.5	mA
$C_T$	Junction Capacitance (Per Leg)	@ $V_R = 24 \text{ V}, T_C = 25^\circ\text{C}, f_{SIG} = 1 \text{ MHz}$	100	-	pF

**Note 1:** Pulse width < 300  $\mu\text{s}$ , duty cycle < 2%

**Thermal-Mechanical Specifications**

Symbol	Characteristics	Condition	Specification	Units
$T_{VJ}$	Junction Temperature	-	-55 to +175	$^\circ\text{C}$
$T_O$	Operation temperature	-	-55 to +150	$^\circ\text{C}$
$T_{stg}$	Storage Temperature	-	-55 to +150	$^\circ\text{C}$
$M_D$	Mounting torque	-	Min 0.4 Max 0.6	Nm
$F_C$	Mounting force with clip	-	Min 20 Max 60	N
$R_{thJC}$	Maximum Thermal Resistance Junction to Case	DC operation	1.75	K/W
$R_{thCS}$	Typical Thermal Resistance Case to Heat Sink	-	0.5	K/W
wt	Approximate Weight	-	2	g

### Characteristic Curves

**Fig. 1. Typical Forward Characteristics**

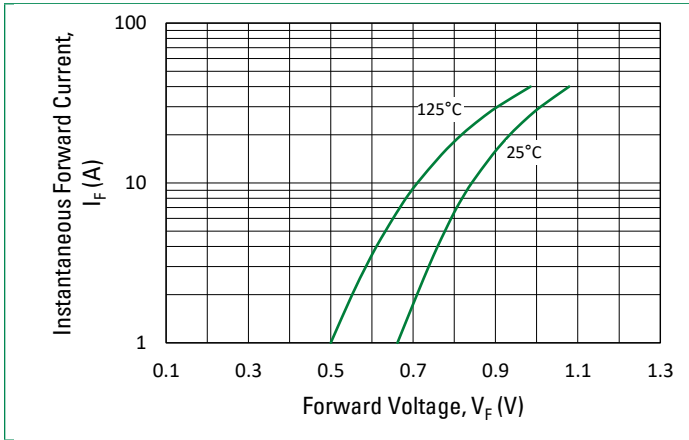

**Fig. 2. Typical Reverse Characteristics**

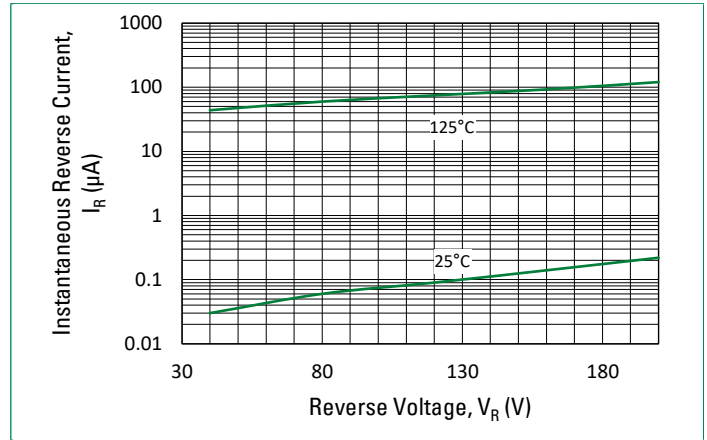

**Fig. 3. Typical Junction Capacitance**

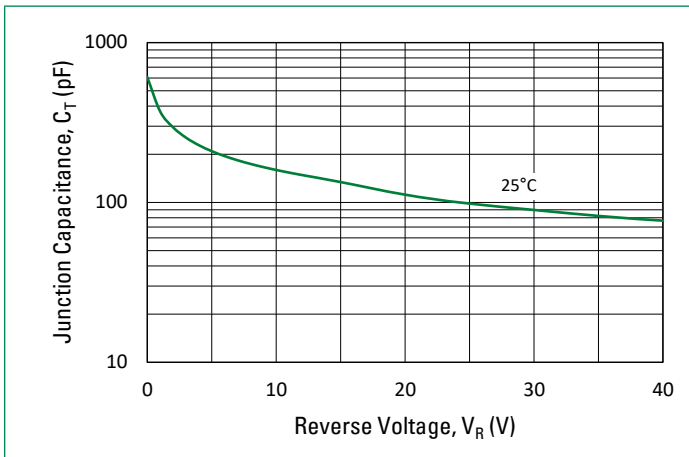

Part Outline Drawing (TO-220-3L AB)

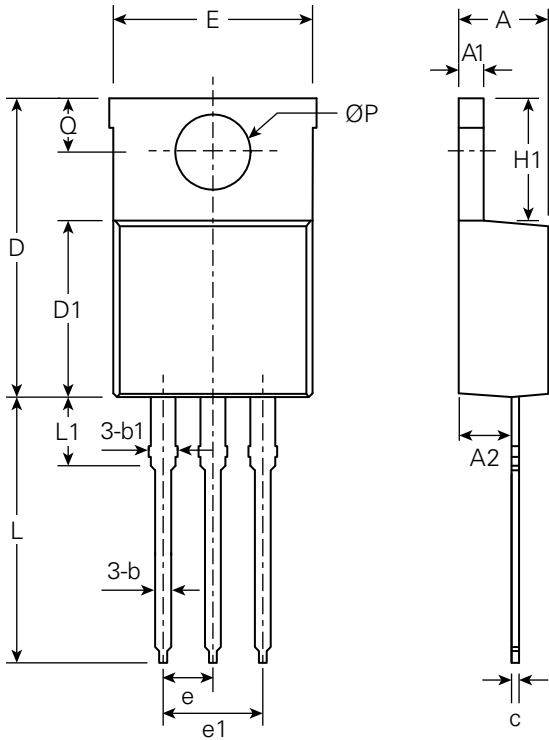

Symbol	Inches			Millimeters		
	Min.	Typical	Max.	Min.	Typical	Max.
A	0.140	–	0.190	3.56	–	4.83
A1	0.020	–	0.055	0.51	–	1.40
A2	0.080	–	0.115	2.03	–	2.92
b	0.015	–	0.040	0.38	–	1.02
b1	0.045	–	0.070	1.14	–	1.78
c	0.012	–	0.024	0.31	–	0.61
D	0.560	–	0.650	14.22	–	16.51
D1	0.330	–	0.371	8.38	–	9.42
E	0.380	–	0.420	9.65	–	10.67
e	–	0.100	–	–	2.54	–
e1	–	0.200	–	–	5.08	–
H1	0.230	–	0.270	5.84	–	6.86
L	0.500	–	0.580	12.70	–	14.73
L1	–	–	0.250	–	–	6.35
ØP	–	0.140	–	–	3.56	–
Q	0.100	–	0.135	2.54	–	3.43

Part Number and Marking

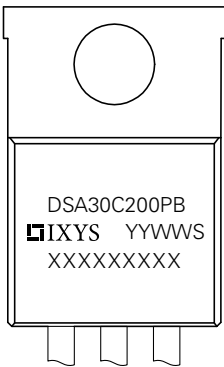

- D = Diode
- S = Schottky Diode
- A Low VF
- 30 = Forward Current (30 A)
- C Common Cathode
- 200 = Reverse Voltage (200 V)
- PB = Package Code (TO-220AB)
- YY = Year
- WW = Work Week
- S = Plant Location Code
- XXXXXXXXX = Lot Number

Ordering Information

Part Number	Marking	Packing Mode	M.O.Q
DSA30C200PB	DSA30C200PB	Tube (50 pcs)	–

Packing Specifications

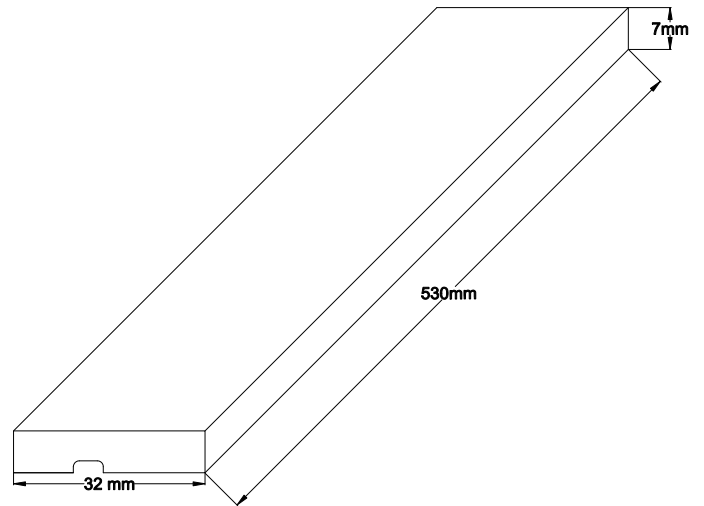

Disclaimer Notice

Information furnished is believed to be accurate and reliable. However, users should independently evaluate the suitability of and test each product selected for their own applications. Littelfuse products are not designed for, and may not be used in, all applications. Read complete Disclaimer Notice at <http://www.littelfuse.com/disclaimer-electronics>.



Part of:

