

DSS10-006A

60 V, 16 A Schottky Rectifier Diode

RoHS

Pb

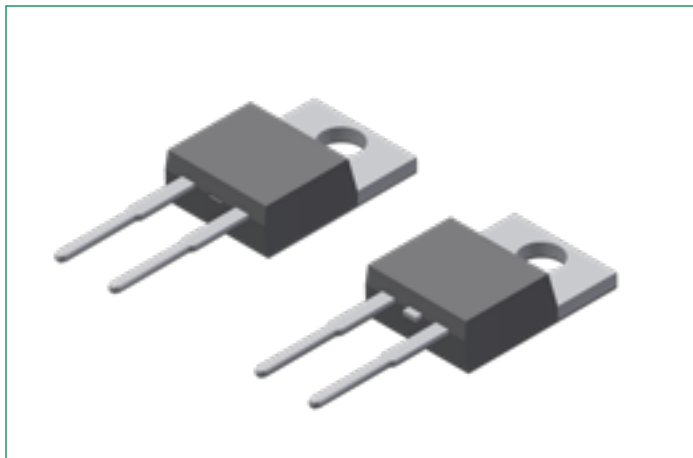

Features & Benefits:

- Very low V_f
- Extremely low switching losses
- Low I_{rm} values
- Improved thermal behavior
- High reliability circuit operation
- Low voltage peaks for reduced protection circuits
- Low noise switching
- Terminals finish: 100% Pure Tin
- This is a Pb – Free Device
- Epoxy meets UL 94V-0

Pinout Diagram (TO-220AC)

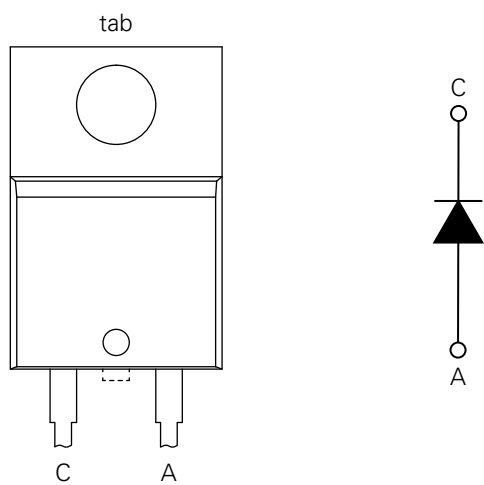

C: Cathode; **A:** Anode; **tab:** Cathode

Applications:

- Rectifiers in switch mode power supplies (SMPS)
- Free wheeling diode in low voltage converters

Maximum Ratings ($T_A = 25^\circ\text{C}$ unless otherwise specified)

| Symbol | Characteristics | Condition | Max. | Units |
|-------------|---|--|------|-------|
| V_{RRM} | Peak Repetitive Reverse Voltage | - | 60 | V |
| V_{RWM} | Working Peak Reverse Voltage | | | |
| V_R | DC Blocking Voltage | | | |
| $I_{F(AV)}$ | Average Rectified Forward Current | 50% duty cycle @ $T_C=160^\circ\text{C}$, rectangular wave form | 10 | A |
| I_{FSM} | Peak One Cycle Non-Repetitive Surge Current | 10 ms, Half Sine pulse, $T_J=25^\circ\text{C}$ | 170 | A |
| P_{tot} | Total power dissipation | $T_C=25^\circ\text{C}$ | 90 | W |

Electrical Characteristics ($T_A = 25^\circ\text{C}$ unless otherwise specified)

| Symbol | Characteristics | Conditions | Typ. | Max. | Units |
|----------|-----------------------------------|---|------|------|---------------|
| V_{F1} | Forward Voltage Drop ¹ | @ 10A, Pulse, $T_J = 25^\circ\text{C}$ | - | 0.80 | V |
| V_{F1} | | @ 10A, Pulse, $T_J = 125^\circ\text{C}$ | - | 0.65 | V |
| I_{R1} | Reverse Current* | @ $V_R = \text{rated } V_R, T_J = 25^\circ\text{C}$ | - | 300 | μA |
| I_{R2} | | @ $V_R = \text{rated } V_R, T_J = 125^\circ\text{C}$ | - | 10 | mA |
| C_T | Junction Capacitance | @ $V_R = 12\text{V}, T_C = 25^\circ\text{C}$ $f_{SIG} = 1\text{MHz}$ | 661 | - | pF |

Note 1: Pulse width < 300 μs , duty cycle < 2%

Thermal-Mechanical Specifications

| Symbol | Characteristics | Condition | Specification | Units |
|-----------------|--|--------------|--------------------|--------------------|
| T_J | Junction Temperature | - | -55 to +175 | $^\circ\text{C}$ |
| T_O | Operation Temperature | - | -55 to +150 | $^\circ\text{C}$ |
| T_{stg} | Storage Temperature | - | -55 to +150 | $^\circ\text{C}$ |
| M_D | Mounting torque | - | Min 0.4 Max 0.6 | Nm |
| F_C | Mounting force with clip | - | Min 20 Max 60 | N |
| $R_{\theta JC}$ | Maximum Thermal Resistance Junction to Case | DC operation | 1.7 | $^\circ\text{C/W}$ |
| $R_{\theta CS}$ | Typical Thermal Resistance Case to Heat Sink | - | 0.5 | $^\circ\text{C/W}$ |
| wt | Approximate Weight | - | 1.6 | g |

Characteristic Curves

Fig. 1. Typical Forward Characteristics

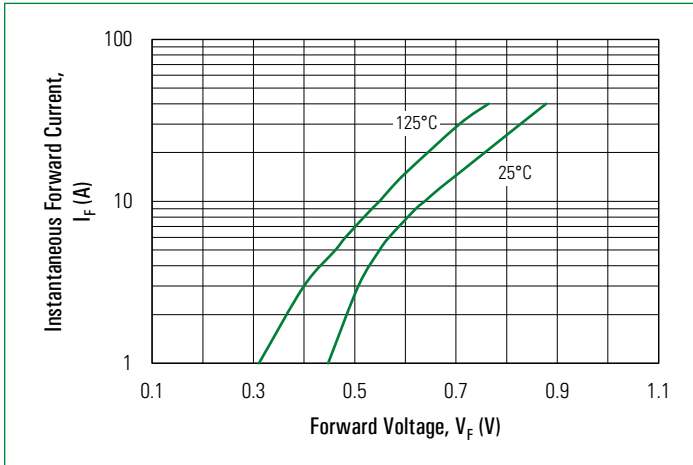

Fig. 2. Typical Reverse Characteristics

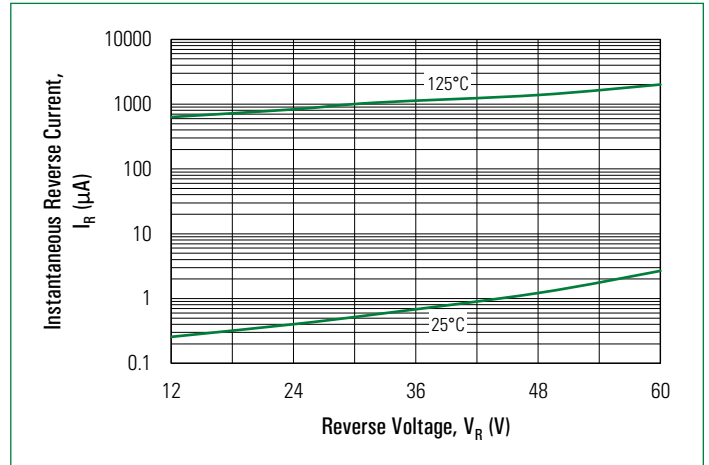
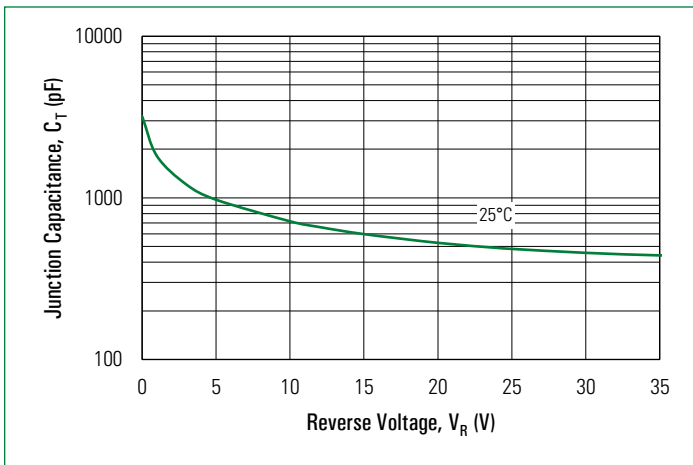
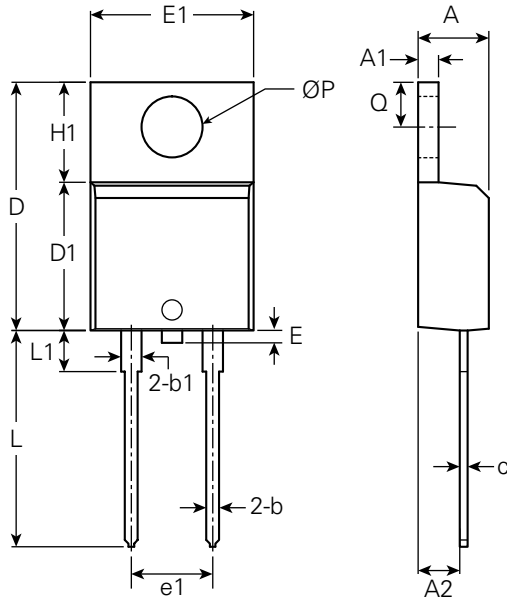

Fig. 3. Typical Junction Capacitance



Part Outline Drawing (TO-220AC)



| Symbol | Inches | | | Millimeters | | |
|--------|--------|---------|------|-------------|---------|-------|
| | Min. | Typical | Max. | Min. | Typical | Max. |
| A | 0.14 | - | 0.19 | 3.56 | - | 4.83 |
| A1 | 0.02 | - | 0.06 | 0.51 | - | 1.40 |
| A2 | 0.08 | - | 0.11 | 2.03 | - | 2.92 |
| b | 0.01 | - | 0.04 | 0.38 | - | 1.02 |
| b1 | 0.04 | - | 0.07 | 1.14 | - | 1.78 |
| c | 0.12 | - | 0.02 | 0.31 | - | 0.61 |
| D | 0.56 | - | 0.65 | 14.22 | - | 16.51 |
| D1 | 0.33 | - | 0.37 | 8.38 | - | 9.42 |
| E | - | - | 0.07 | - | - | 1.78 |
| E1 | 0.38 | 0.40 | 0.42 | 9.65 | 10.16 | 10.67 |
| e1 | - | 0.20 | - | - | 5.08 | - |
| H1 | 0.23 | - | 0.27 | 5.84 | - | 6.86 |
| L | 0.50 | - | 0.58 | 12.70 | - | 14.73 |
| L1 | - | - | 0.25 | - | - | 6.35 |
| Q | 0.1 | - | 0.13 | 2.54 | - | 3.43 |
| ØP | - | 0.14 | - | - | 3.56 | - |

Part Number and Marking

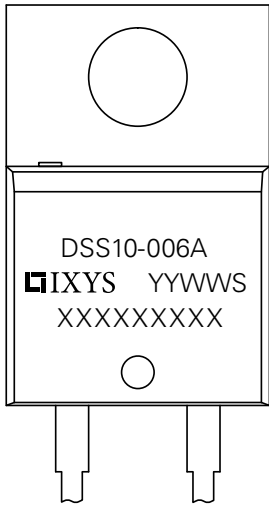

- D = Diode
- S = Schottky Diode
- S = Product Generation
- 10 = Current Rate
- 006 = Voltage Rating
- A = Package Code
- YY = Year
- WW = Work Week
- S = Plant Location Code
- XXXXXXXXXX = Lot Number

Ordering Information

| Part Number | Marking | Packing Mode | Quantity |
|-------------|------------|--------------|--------------|
| DSS10-006A | DSS10-006A | Tube | 50 pcs/ tube |

Packing Specifications

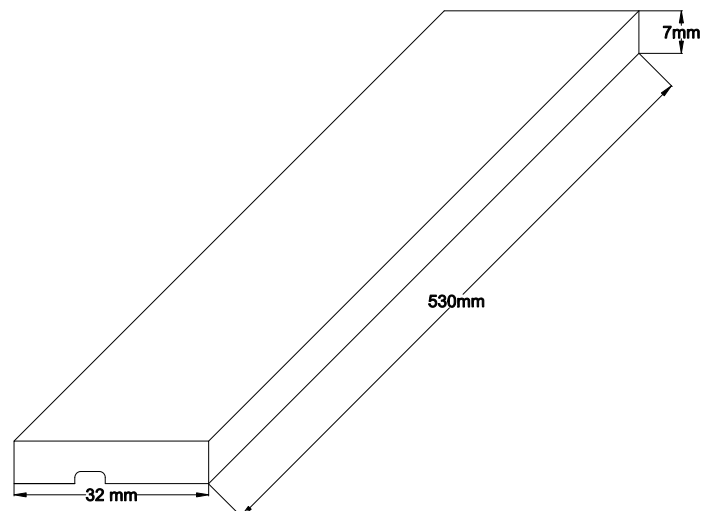

Disclaimer Notice - Information furnished is believed to be accurate and reliable. However, users should independently evaluate the suitability of and test each product selected for their own applications. Littelfuse products are not designed for, and may not be used in, all applications. Read complete Disclaimer Notice at <http://www.littelfuse.com/disclaimer-electronics>.