

DSS6-0025BS

25 V, 6 A Schottky Rectifier Diode

RoHS

Pb

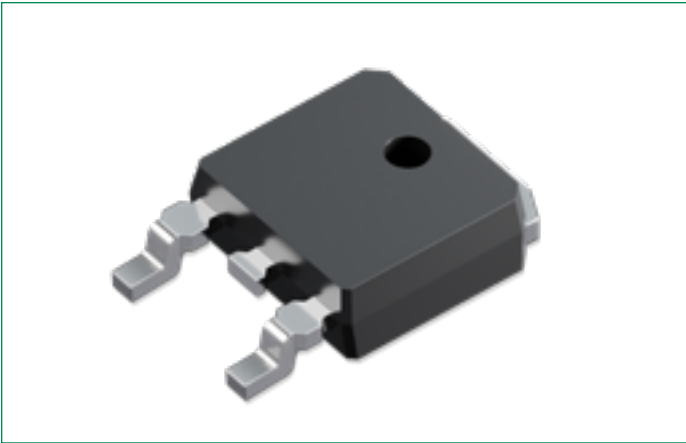

Features:

- Very low V_f
- Extremely low switching losses
- Low I_{rm} values
- Improved thermal behavior
- High reliability circuit operation
- Low voltage peaks for reduced protection circuits
- Low noise switching
- Terminals finish: 100% Pure Tin
- This is a Pb – Free Device
- Epoxy meets UL 94V-0

Pinout Diagram (TO-252AA)

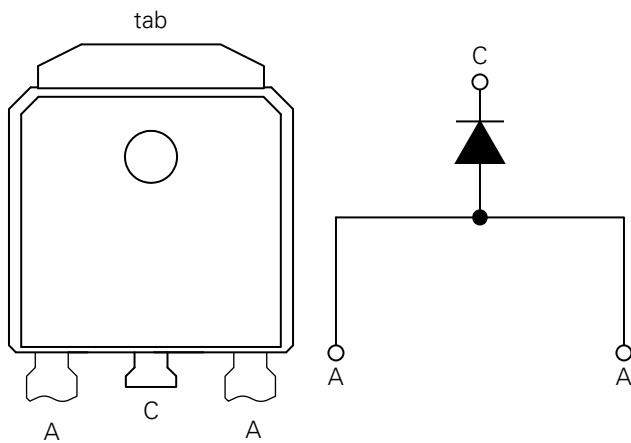

C: Cathode; **A:** Anode; **tab:** Cathode

Applications:

- Rectifiers in switch mode power supplies (SMPS)
- Free wheeling diode in low voltage converters

Maximum Ratings ($T_A = 25^\circ\text{C}$ unless otherwise specified)

Symbol	Characteristics	Condition	Max.	Units
V_{RRM}	Peak Repetitive Reverse Voltage	–	25	V
V_{RWM}	Working Peak Reverse Voltage			
V_R	DC Blocking Voltage			
$I_{F(AV)}$	Average Rectified Forward Current	50% duty cycle @ $T_C=140^\circ\text{C}$, rectangular wave form	6	A
I_{FSM}	Peak One Cycle Non-Repetitive Surge Current	10 ms, Half Sine pulse, $T_J=25^\circ\text{C}$	120	A
P_{tot}	Total power dissipation	$T_C=25^\circ\text{C}$	40	W

Electrical Characteristics ($T_A = 25^\circ\text{C}$ unless otherwise specified)

Symbol	Characteristics	Conditions	Typ.	Max.	Units
V_{F1}	Forward Voltage Drop ¹	@ 6A, Pulse, $T_J = 25^\circ\text{C}$	–	0.45	V
V_{F2}		@ 6A, Pulse, $T_J = 125^\circ\text{C}$	–	0.35	V
I_{R1}	Reverse Current*	@ $V_R = \text{rated } V_{R'}$, $T_J = 25^\circ\text{C}$	–	5	mA
I_{R2}		@ $V_R = \text{rated } V_{R'}$, $T_J = 125^\circ\text{C}$	–	40	mA
C_T	Junction Capacitance	@ $V_R = 5\text{V}$, $T_C = 25^\circ\text{C}$, $f_{SIG} = 1\text{MHz}$	661	–	pF

Note 1: Pulse width < 300 μs , duty cycle < 2%

Thermal-Mechanical Specifications

Symbol	Characteristics	Condition	Specification	Units
T_J	Junction Temperature	–	-55 to +150	$^\circ\text{C}$
T_O	Operation Temperature	–	-55 to +125	$^\circ\text{C}$
T_{stg}	Storage Temperature	–	-55 to +150	$^\circ\text{C}$
F_C	Mounting force with clip	–	Min 20 Max 60	N
$R_{\theta JC}$	Maximum Thermal Resistance Junction to Case	DC operation	3	$^\circ\text{C/W}$
$R_{\theta CS}$	Typical Thermal Resistance Case to Heat Sink	–	0.50	$^\circ\text{C/W}$
wt	Approximate Weight	–	0.39	g

Characteristic Curves

Fig. 1. Typical Forward Characteristics

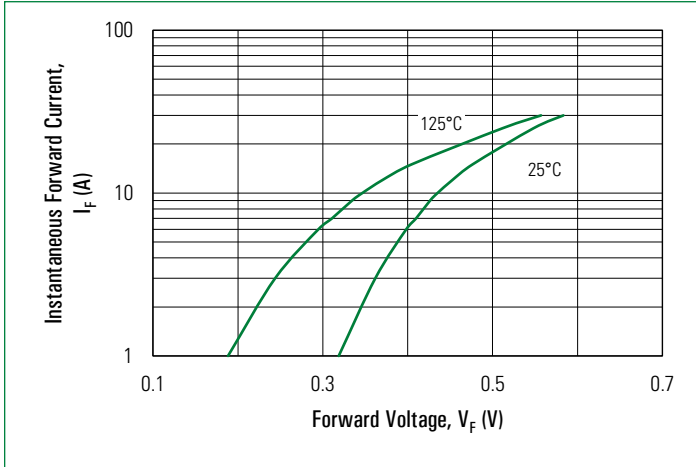

Fig. 2. Typical Reverse Characteristics

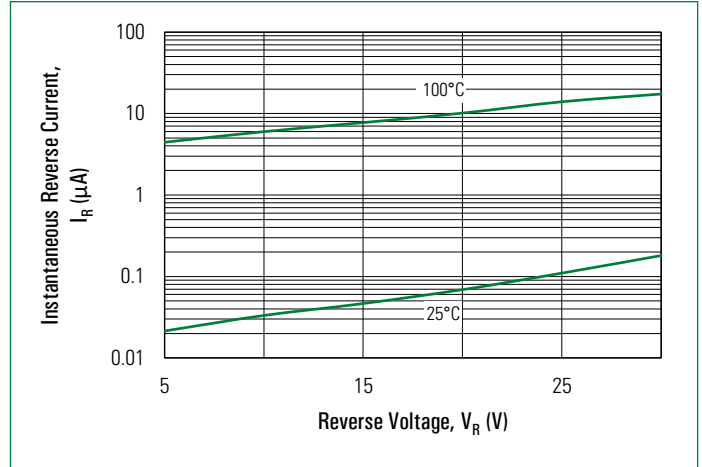
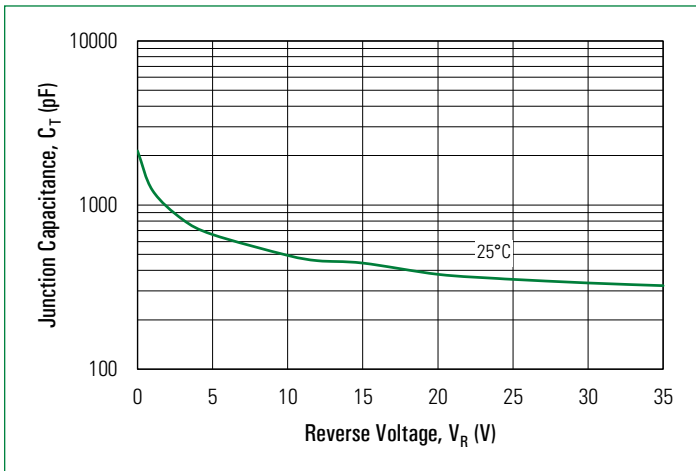
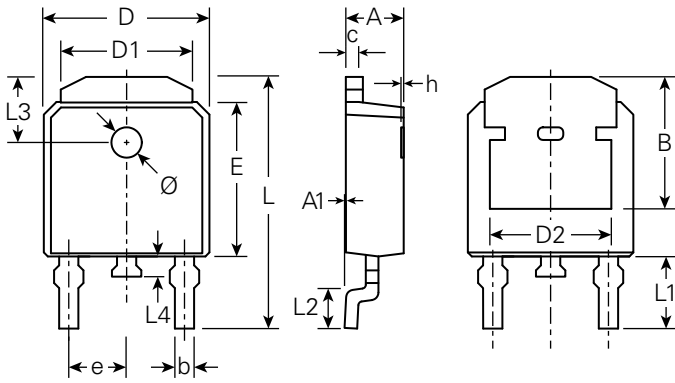

Fig. 3. Typical Junction Capacitance



Part Outline Drawing (TO-252AA)



Symbol	Inches			Millimeters		
	Min.	Typical	Max.	Min.	Typical	Max
A	0.085	-	0.094	2.18	-	2.39
A1	-	-	0.005	-	-	0.13
b	0.025	-	0.035	0.64	-	0.89
c	0.018	-	0.035	0.46	-	0.89
D	0.250	-	0.264	6.35	-	6.73
D1	0.195	-	0.215	4.95	-	5.46
D2	0.170	-	-	4.32	-	-
E	0.235	0.240	0.245	5.97	6.10	6.22
e	0.090 BSC			2.29 BSC		
L	0.370	-	0.410	9.40	-	10.41
L1	0.114			2.90 REF		
L2	0.055	0.060	0.070	1.40	1.52	1.78
L3	0.063 REF			1.60 REF		
L4	-	-	0.040	-	-	1.02
Ø	0.043	-	0.051	1.10	-	1.30

Part Number and Marking

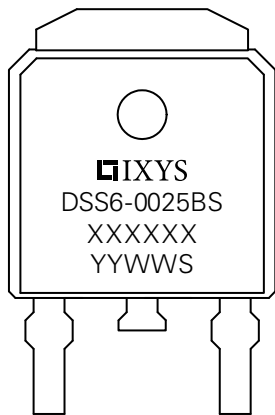

- D = Diode
- S = Schottky Diode
- S = Product Generation
- 6 = Current Rate (6A)
- 0025 = Voltage Rating (25V)
- BS = Package Code
- YY = Year
- WW = Work Week
- S = Plant Location Code
- XXXXXX = Lot Number

Ordering Information

Part Number	Marking	Packing Mode	Quantity
DSS6-0025BS-TRL	DSS6-0025BS	Reel	2500 pcs/ reel

Carrier Tape Specification (TO-252AA)

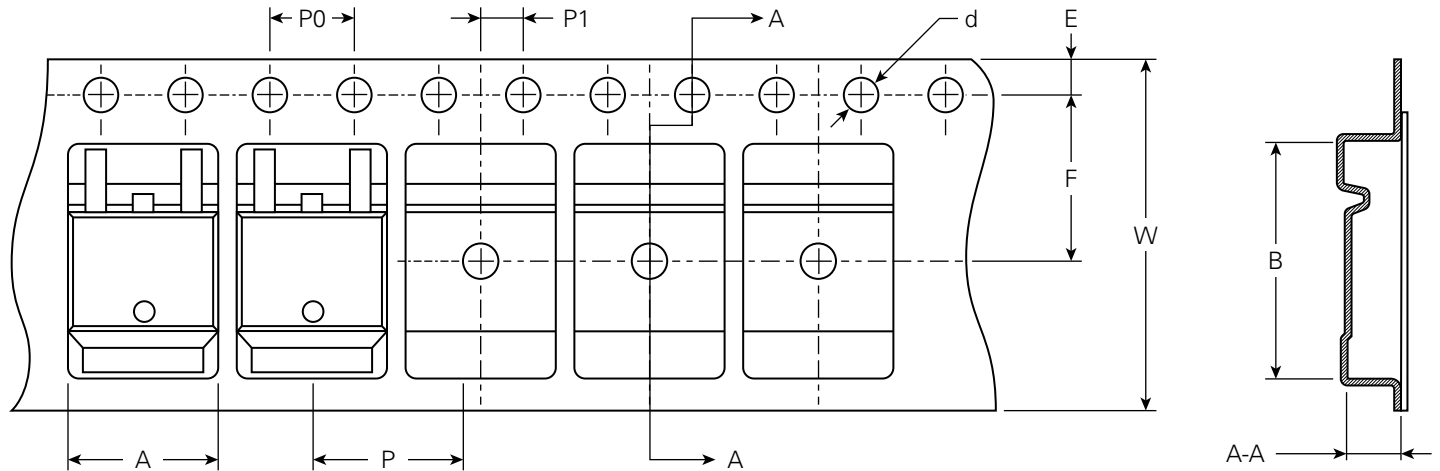

Symbol	Inches			Millimeters		
	Min.	Typical	Max.	Min.	Typical	Max.
A	0.267	–	0.276	6.80	–	7.00
B	0.409	–	0.417	10.40	–	10.60
C	0.102	–	0.110	2.60	–	2.80
d	Ø0.057	–	Ø0.065	Ø1.45	–	Ø1.65
E	0.065	–	0.073	1.65	–	1.85
F	0.291	–	0.299	7.40	–	7.60
P0	0.154	–	0.161	3.90	–	4.10
P	0.311	–	0.319	7.90	–	8.10
P1	0.075	–	0.083	1.90	–	2.10
W	0.626	–	0.642	15.90	–	16.30

Disclaimer Notice - Information furnished is believed to be accurate and reliable. However, users should independently evaluate the suitability of and test each product selected for their own applications. Littelfuse products are not designed for, and may not be used in, all applications. Read complete Disclaimer Notice at <http://www.littelfuse.com/disclaimer-electronics>.