

# DSS6-0045AS

## 45 V, 6 A Schottky Rectifier Diode

RoHS

Pb



### Features:

- Very low  $V_F$
- Extremely low switching losses
- Low  $I_{RM}$  values
- Improved thermal behavior
- High reliability circuit operation
- Low voltage peaks for reduced protection circuits
- Low noise switching
- Terminals finish: 100% pure tin
- This is a Pb-free device
- Epoxy meets UL 94 V-0

### Pinout Diagram (TO-252AA)

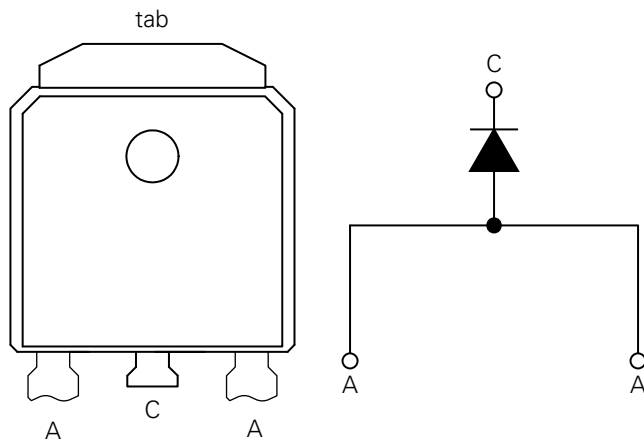

**C:** Cathode; **A:** Anode; **tab:** Cathode

### Applications:

- Rectifiers in Switch Mode Power Supplies (SMPS)
- Free wheeling diode in low voltage converters

### Product Summary

Characteristic	Value	Unit
$V_{RRM}$	45	V
$I_{FAV}$	6	A
$V_F$	0.53	V

**Maximum Ratings** ( $T_A = 25^\circ\text{C}$  unless otherwise specified)

Symbol	Characteristics	Condition	Max.	Units
$V_{RRM}$	Peak Repetitive Reverse Voltage	–	45	V
$V_{RWM}$	Working Peak Reverse Voltage			
$V_R$	DC Blocking Voltage			
$I_{FAV}$	Average Rectified Forward Current	50% duty cycle @ $T_C = 165^\circ\text{C}$ , rectangular wave form	6	A
$I_{FSM}$	Peak One Cycle Non-Repetitive Surge Current	10 ms, Half Sine pulse, $T_{VJ} = 25^\circ\text{C}$	120	A
$P_{tot}$	Total power dissipation	$T_C = 25^\circ\text{C}$	50	W

**Electrical Characteristics** ( $T_A = 25^\circ\text{C}$  unless otherwise specified)

Symbol	Characteristics	Conditions	Typ.	Max.	Units
$V_{F1}$	Forward Voltage Drop <sup>1</sup>	@ 6 A, Pulse, $T_{VJ} = 25^\circ\text{C}$	–	0.63	V
$V_{F2}$		@ 6 A, Pulse, $T_{VJ} = 125^\circ\text{C}$	–	0.53	V
$I_{R1}$	Reverse Current*	@ $V_R = \text{rated } V_R, T_{VJ} = 25^\circ\text{C}$	–	250	$\mu\text{A}$
$I_{R2}$		@ $V_R = \text{rated } V_R, T_{VJ} = 125^\circ\text{C}$	–	2.5	mA
$C_T$	Junction Capacitance	@ $V_R = 12\text{ V}, T_C = 25^\circ\text{C}, f_{SIG} = 1\text{ MHz}$	223	–	pF

**Note 1:** Pulse width < 300  $\mu\text{s}$ , duty cycle < 2%

**Thermal-Mechanical Specifications**

Symbol	Characteristics	Condition	Specification	Units
$T_{VJ}$	Junction Temperature	–	-55 to +175	$^\circ\text{C}$
$T_O$	Operation Temperature	–	-55 to +150	$^\circ\text{C}$
$T_{stg}$	Storage Temperature	–	-55 to +150	$^\circ\text{C}$
$F_C$	Mounting force with clip	–	Min 20 Max 60	N
$R_{thJC}$	Maximum Thermal Resistance Junction to Case	DC operation	3	K/W
$R_{thCS}$	Typical Thermal Resistance Case to Heat Sink	–	0.50	K/W
wt	Approximate Weight	–	0.39	g

### Characteristic Curves

**Fig. 1. Typical Forward Characteristics**

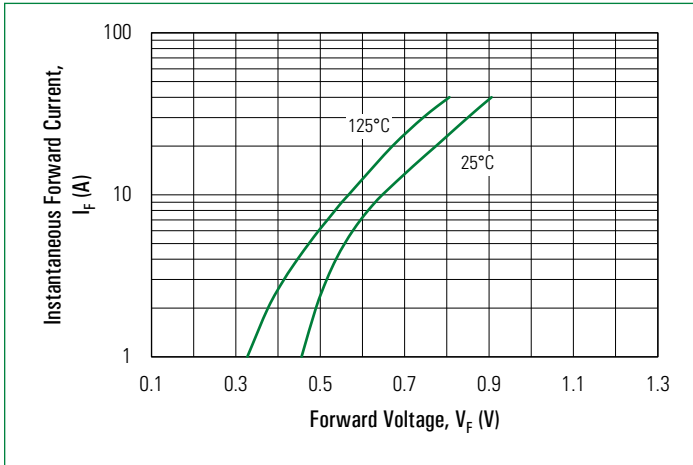

**Fig. 2. Typical Reverse Characteristics**

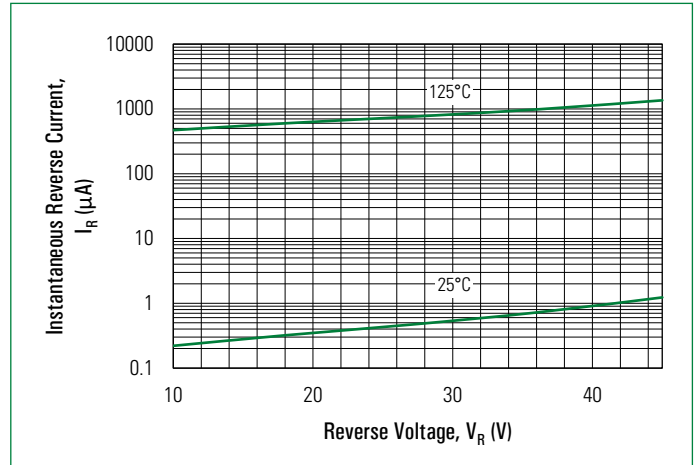

**Fig. 3. Typical Junction Capacitance**

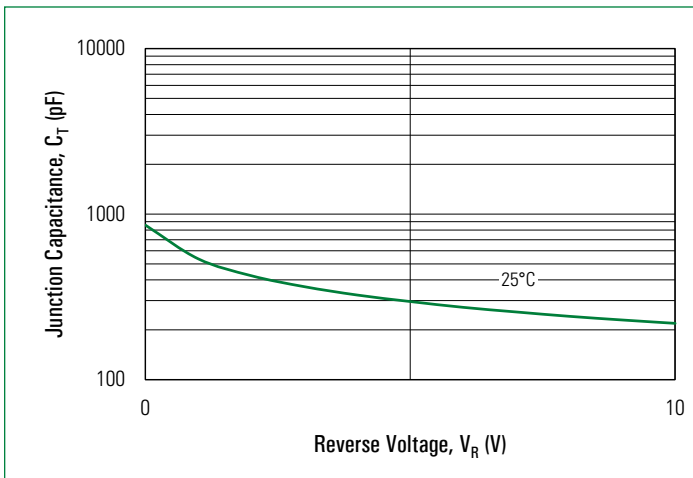

Part Outline Drawing (TO-252AA)

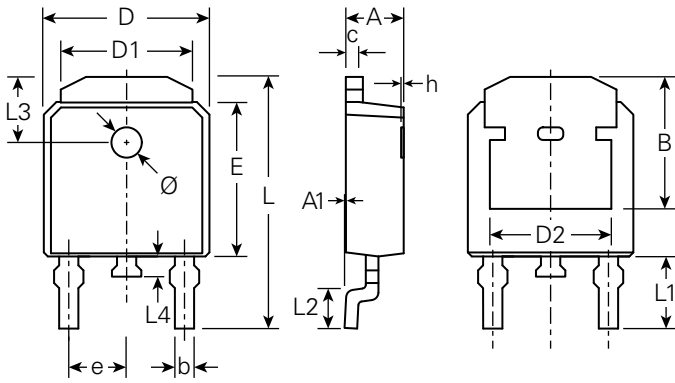

Symbol	Inches			Millimeters		
	Min.	Typical	Max.	Min.	Typical	Max
A	0.085	-	0.094	2.18	-	2.39
A1	-	-	0.005	-	-	0.13
b	0.025	-	0.035	0.64	-	0.89
c	0.018	-	0.035	0.46	-	0.89
D	0.250	-	0.264	6.35	-	6.73
D1	0.195	-	0.215	4.95	-	5.46
D2	0.170	-	-	4.32	-	-
E	0.235	0.240	0.245	5.97	6.10	6.22
e	0.090 BSC			2.29 BSC		
L	0.370	-	0.410	9.40	-	10.41
L1	0.114			2.90 REF		
L2	0.055	0.060	0.070	1.40	1.52	1.78
L3	0.063 REF			1.60 REF		
L4	-	-	0.040	-	-	1.02
Ø	0.043	-	0.051	1.10	-	1.30

Part Number and Marking

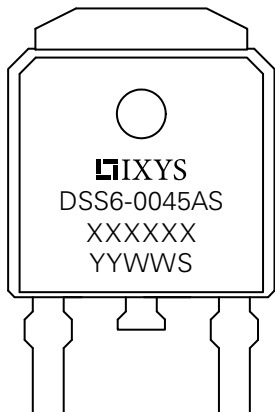

- DS = Schottky Diode
- S = Product Generation
- 6 = Current Rate
- 0045 = Voltage Rating
- AS = Package Code
- YY = Year
- WW = Work Week
- S = Plant Location Code
- XXXXXX = Lot Number

Ordering Information

Part Number	Marking	Packing Mode	Quantity
DSS6-0045AS-TRL	DSS6-0045AS	Reel	2500 pcs/ reel

Carrier Tape Specification (TO-252AA)

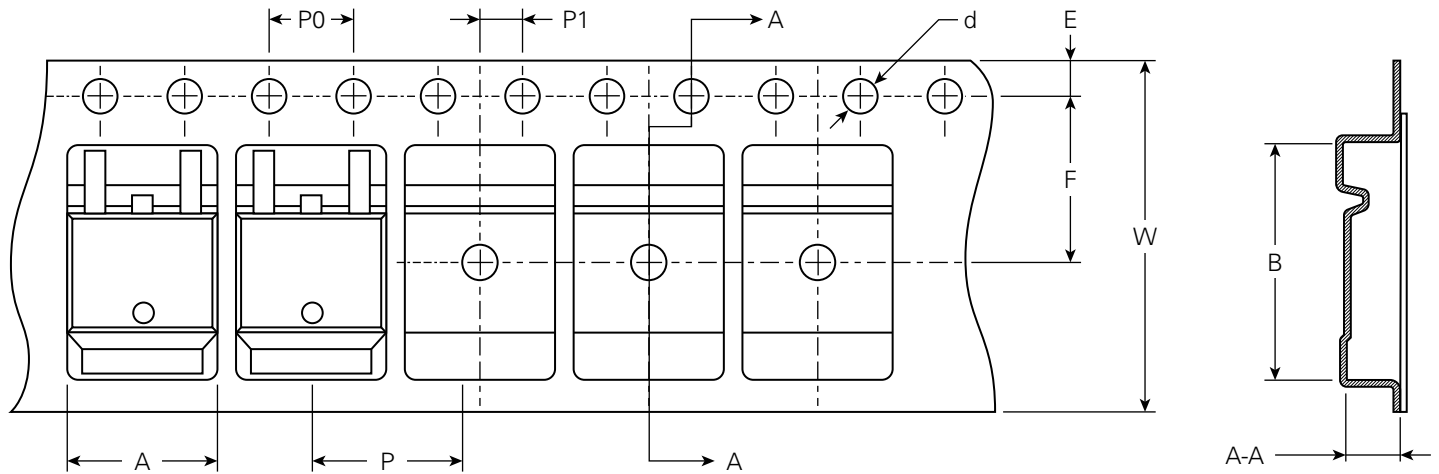

Symbol	Inches			Millimeters		
	Min.	Typical	Max.	Min.	Typical	Max.
A	0.267	-	0.276	6.80	-	7.00
B	0.409	-	0.417	10.40	-	10.60
C	0.102	-	0.110	2.60	-	2.80
d	Ø0.057	-	Ø0.065	Ø1.45	-	Ø1.65
E	0.065	-	0.073	1.65	-	1.85
F	0.291	-	0.299	7.40	-	7.60
P0	0.154	-	0.161	3.90	-	4.10
P	0.311	-	0.319	7.90	-	8.10
P1	0.075	-	0.083	1.90	-	2.10
W	0.626	-	0.642	15.90	-	16.30

Disclaimer Notice

Information furnished is believed to be accurate and reliable. However, users should independently evaluate the suitability of and test each product selected for their own applications. Littelfuse products are not designed for, and may not be used in, all applications. Read complete Disclaimer Notice at <http://www.littelfuse.com/disclaimer-electronics>.



Part of:

