

# IXYH30N120C4H1

1200 V, 30 A XPT™ Gen4 IGBT with Sonic Diode

Extreme Light Punch Through IGBT for 20–50 kHz Switching

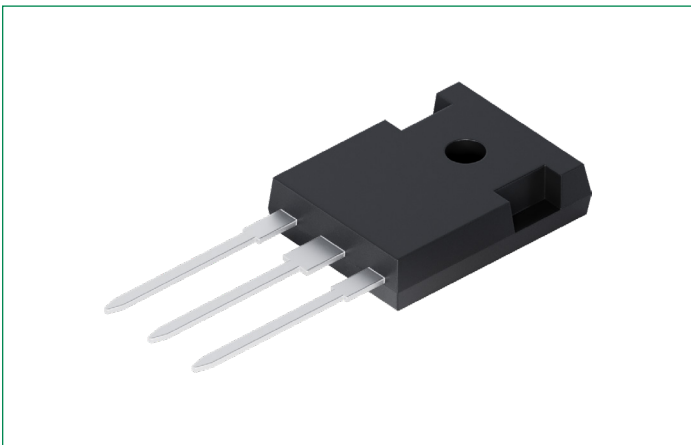

Pinout Diagram (TO-247-3L)

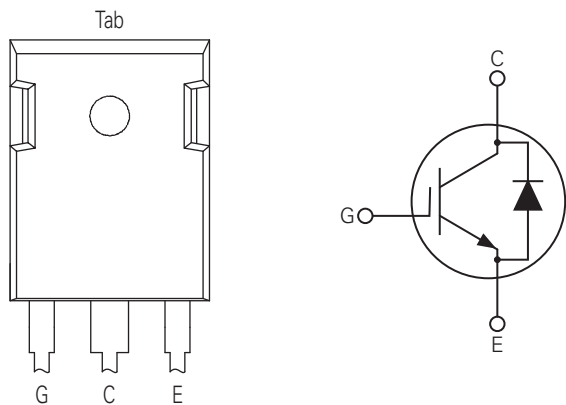

**G:** Gate; **C:** Collector; **E:** Emitter; **Tab:** Collector

## Description:

Developed using our proprietary XPT™ thin-wafer technology and state-of-the-art Trench IGBT process, these devices feature reduced thermal resistance, low energy losses, fast switching, low tail current, and high current densities.

## Features & Benefits:

- Optimized for 20–50 kHz Switching
- High Surge Current Capability
- Square RBSOA
- International Standard Package
- Anti-Parallel Sonic Diode

## Applications:

- Power Inverters
- UPS
- Motor Drives
- SMPS
- PFC Circuits
- Battery Chargers
- Welding Machines

## Product Summary

Characteristic	Value	Unit
$V_{CES}$	1200	V
$I_{C110}$	30	A
$V_{CE(sat)}$	2.0	V
$t_{fi(typ)}$	53	ns

## Maximum Ratings

Symbol	Characteristic	Conditions	Value	Unit
$V_{CES}$	Collector-Emitter Voltage	$T_{VJ} = 25\text{ °C to }175\text{ °C}$	1200	V
$V_{GES}$	Gate-Emitter Voltage	Continuous	$\pm 20$	V
$V_{GEM}$	Transient Gate-Emitter Voltage	Transient	$\pm 30$	V
$I_{C25}$	Continuous Collector Current	$T_C = 25\text{ °C}$	94	A
$I_{C110}$	Continuous Collector Current	$T_C = 110\text{ °C}$	30	A
$I_{F110}$	Diode Forward Current	$T_C = 110\text{ °C}$	28	A
$I_{CM}$	Pulsed Collector Current	$T_C = 25\text{ °C}, 1\text{ ms}$	166	A
SSOA (RBSOA)	Switching Safe Operating Area (Reverse Biased Safe Operating Area)	$V_{GE} = 15\text{ V}, T_{VJ} = 115\text{ °C}, R_G = 5\text{ }\Omega,$ Clamped Inductive Load, $I_{CM} @ V_{CE} \leq 0.8 \times V_{CES}$	60	A
$P_C$	Collector Power Dissipation	$T_C = 25\text{ °C}$	500	W
$T_{VJ}$	Virtual Junction Temperature	–	–55 to 175	°C
$T_{stg}$	Storage Temperature	–	–55 to 175	°C
$T_L$	Lead Temperature for Soldering	1.6 mm (0.062 in.) from Case for 10 s	300	°C
$M_d$	Mounting Torque	–	1.13 / 10	Nm/lb.in
W	Weight	–	6	g

## Thermal Characteristics

Symbol	Characteristic	Conditions	Value			Unit
			Min.	Typ.	Max.	
$R_{th, JC}$	Thermal Resistance, junction-to-case, IGBT	–	–	–	0.30	K/W
$R_{th, CS}$	Thermal Resistance, case-to-heat sink	–	–	21	–	K/W

## Electrical Characteristics – Static ( $T_{VJ} = 25\text{ °C}$ unless otherwise specified)

Symbol	Characteristic	Conditions	Value			Unit
			Min.	Typ.	Max.	
$BV_{CES}$	Collector-Emitter Breakdown Voltage	$I_C = 250\text{ }\mu\text{A}, V_{GE} = 0\text{ V}$	1200	–	–	V
$V_{GE(th)}$	Gate-Emitter Threshold Voltage	$I_C = 250\text{ }\mu\text{A}, V_{CE} = V_{GE}$	4.0	–	6.5	V
$I_{GES}$	Gate-Emitter Leakage Current	$V_{CE} = 0\text{ V}, V_{GE} = \pm 20\text{ V}$	–	–	$\pm 100$	nA
$I_{CES}$	Zero Gate Voltage Collector Current	$V_{CE} = V_{CES}, V_{GE} = 0\text{ V}$	–	–	50	$\mu\text{A}$
		$V_{CE} = V_{CES}, V_{GE} = 0\text{ V}, T_{VJ} = 125\text{ °C}$	–	–	5	mA
$V_{CE(sat)}$	Collector-Emitter Saturation Voltage <sup>1</sup>	$I_C = 25\text{ A}, V_{GE} = 15\text{ V}$	–	2.0	2.4	V
		$I_C = 25\text{ A}, V_{GE} = 15\text{ V}, T_{VJ} = 150\text{ °C}$	–	2.4	–	V

**Note 1:** Pulse test,  $t \leq 300\text{ }\mu\text{s}$ , duty cycle,  $d \leq 2\%$

## Electrical Characteristics – Dynamic ( $T_{VJ} = 25^{\circ}\text{C}$ unless otherwise specified)

Symbol	Characteristic	Conditions	Value			Unit	
			Min.	Typ.	Max.		
$g_{fs}$	Transconductance <sup>1</sup>	$I_C = 25\text{ A}, V_{CE} = 10\text{ V}$	9.0	15.5	–	S	
$C_{ies}$	Input Capacitance	$V_{GE} = 0\text{ V}, V_{CE} = 25\text{ V}, f = 1\text{ MHz}$	–	1150	–	pF	
$C_{oes}$	Output Capacitance		–	110	–		
$C_{res}$	Reverse Transfer Capacitance		–	40	–		
$Q_{g(on)}$	Total Gate Charge	$V_{GE} = 15\text{ V}, V_{CE} = 0.5 \times V_{CES},$ $I_C = 25\text{ A}$	–	57	–	nC	
$Q_{ge}$	Gate-Emitter Charge		–	10	–		
$Q_{gc}$	Gate-Collector Charge		–	26	–		
$t_{d(on)}$	Turn-on Delay Time <sup>2</sup>	Inductive Load, $V_{GE} = 15\text{ V},$ $V_{CE} = 0.8 \times V_{CES},$ $I_C = 25\text{ A},$ $R_{G(ext)} = 5\ \Omega$	$T_{VJ} = 25^{\circ}\text{C}$	–	18	–	ns
			$T_{VJ} = 125^{\circ}\text{C}$	–	16	–	
$t_{ri}$	Turn-on Rise Time <sup>2</sup>		$T_{VJ} = 25^{\circ}\text{C}$	–	58	–	ns
			$T_{VJ} = 125^{\circ}\text{C}$	–	40	–	
$E_{on}$	Turn-on Energy <sup>2</sup>		$T_{VJ} = 25^{\circ}\text{C}$	–	4.8	–	mJ
			$T_{VJ} = 125^{\circ}\text{C}$	–	5.6	–	
$t_{d(off)}$	Turn-off Delay Time <sup>2</sup>		$T_{VJ} = 25^{\circ}\text{C}$	–	205	–	ns
			$T_{VJ} = 125^{\circ}\text{C}$	–	260	–	
$t_{fi}$	Turn-off Fall Time <sup>2</sup>		$T_{VJ} = 25^{\circ}\text{C}$	–	53	–	ns
			$T_{VJ} = 125^{\circ}\text{C}$	–	100	–	
$E_{off}$	Turn-off Energy <sup>2</sup>	$T_{VJ} = 25^{\circ}\text{C}$	–	1.5	–	mJ	
		$T_{VJ} = 125^{\circ}\text{C}$	–	2.7	–		

**Note 1:** Pulse test,  $t \leq 300\ \mu\text{s}$ , duty cycle,  $d \leq 2\%$

**Note 2:** Switching times and energy losses may increase for higher  $V_{CE(clamp)}$ ,  $T_{VJ}$ , or  $R_G$ .

## Reverse Sonic Diode ( $T_{VJ} = 25^{\circ}\text{C}$ unless otherwise specified)

Symbol	Characteristic	Conditions	Value			Unit
			Min.	Typ.	Max.	
$V_F$	Diode Forward Voltage <sup>1</sup>	$I_F = 30\text{ A}, V_{GE} = 0\text{ V}$	–	1.85	2.4	V
		$I_F = 30\text{ A}, V_{GE} = 0\text{ V}, T_{VJ} = 150^{\circ}\text{C}$	–	2.15	–	
$I_{RM}$	Reverse Recovery Current	$I_F = 30\text{ A}, V_{GE} = 0\text{ V}, T_{VJ} = 150^{\circ}\text{C}$	–	20	–	A
$t_{rr}$	Reverse Recovery Time	$-di_F/dt = 400\text{ A}/\mu\text{s}, V_R = 600\text{ V}$	–	310	–	ns
$R_{th, JC}$	Thermal Resistance, junction-to-case	–	–	–	0.52	K/W

**Note 1:** Pulse test,  $t \leq 300\ \mu\text{s}$ , duty cycle,  $d \leq 2\%$

Characteristic Curves

Fig. 1. Output Characteristics @  $T_{VJ} = 25\text{ }^\circ\text{C}$

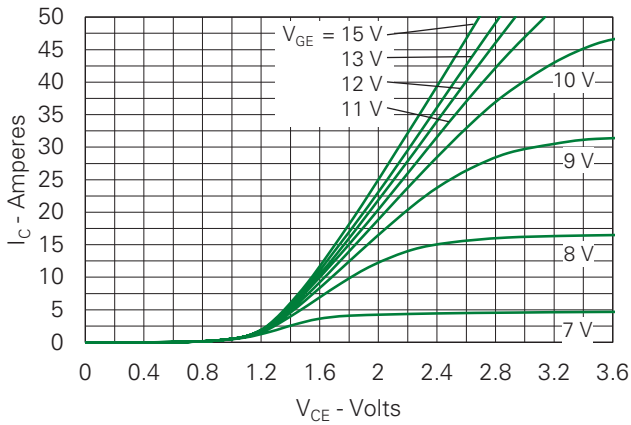

Fig. 2. Extended Output Characteristics @  $T_{VJ} = 25\text{ }^\circ\text{C}$

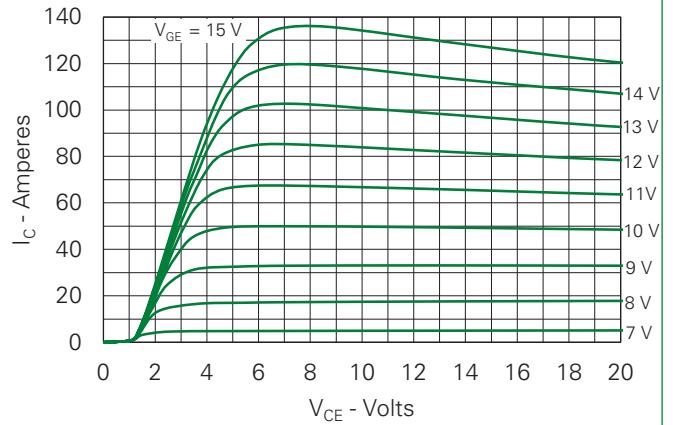

Fig. 3. Output Characteristics @  $T_{VJ} = 150\text{ }^\circ\text{C}$

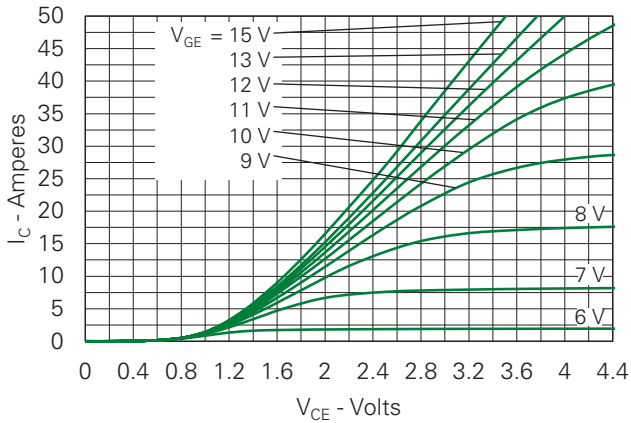

Fig. 4. Dependence of  $V_{CE(sat)}$  on Junction Temperature

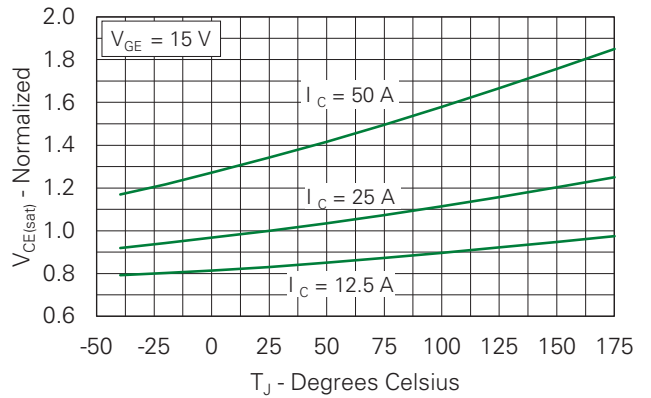

Fig. 5. Collector-to-Emitter Voltage vs. Gate-to-Emitter Voltage

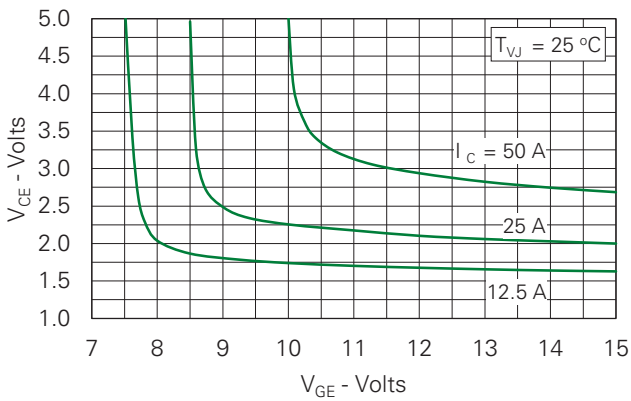

Fig. 6. Input Admittance

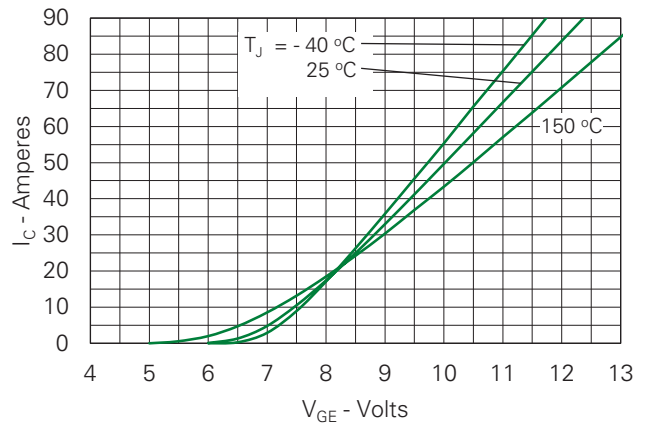

Fig. 7. Transconductance

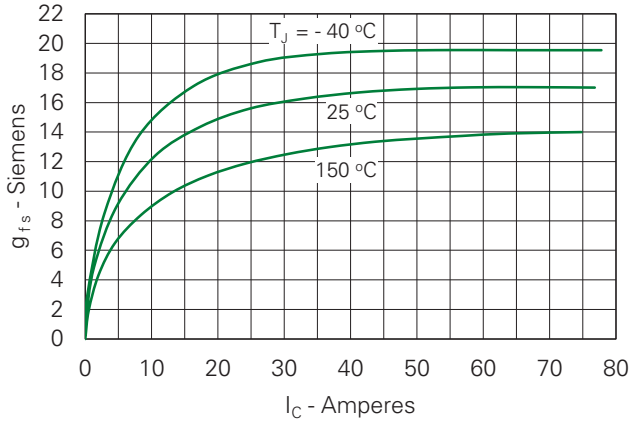

Fig. 8. Gate Charge

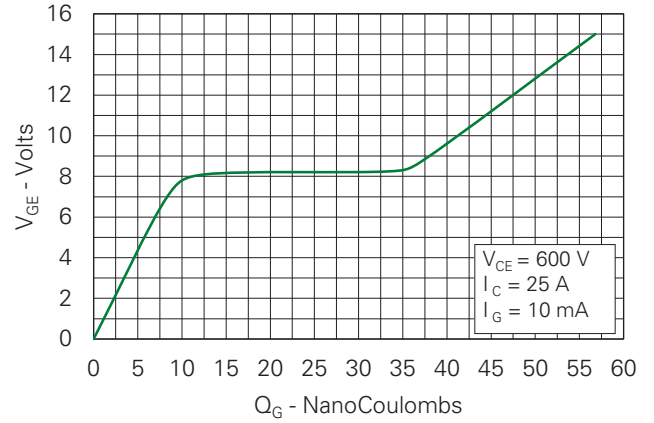

Fig. 9. Capacitance

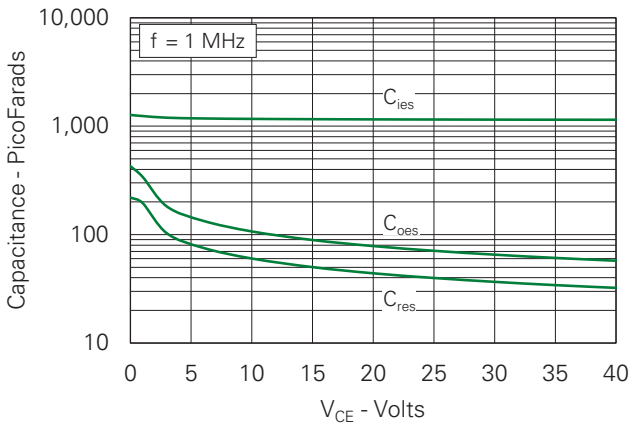

Fig. 10. Reverse-Bias Safe Operating Area

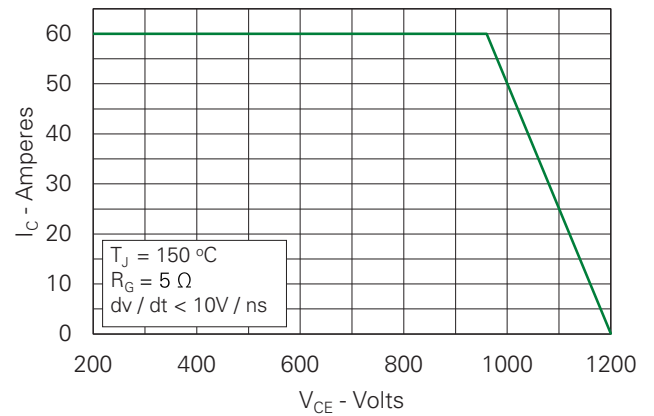

Fig. 11. Maximum Transient Thermal Impedance (IGBT)

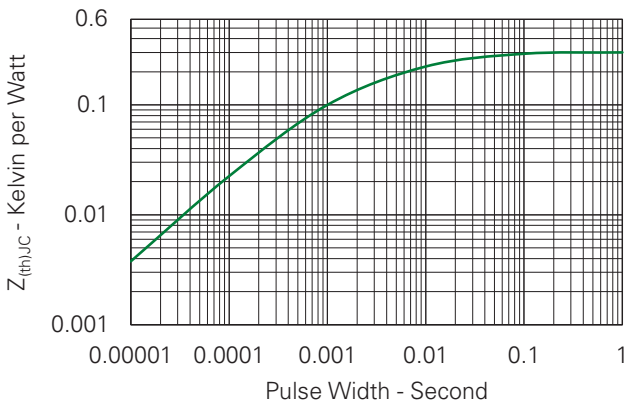
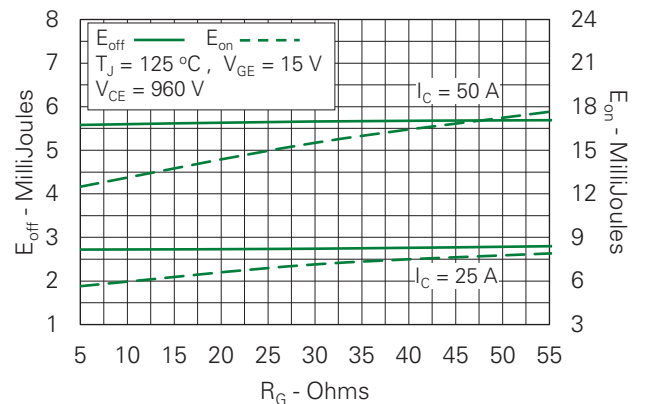
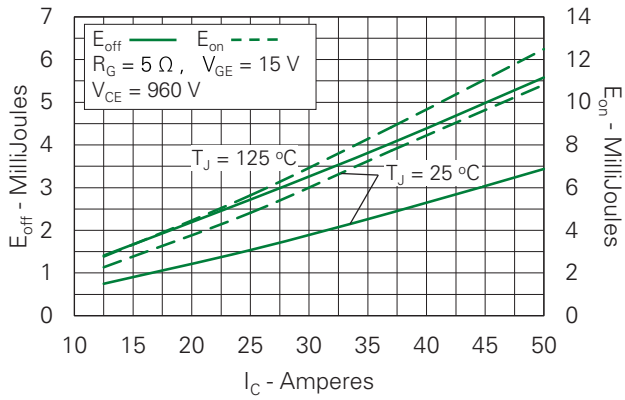

Fig. 12. Inductive Switching Energy Loss vs. Gate Resistance



**Fig. 13. Inductive Switching Energy Loss vs. Collector Current**



**Fig. 14. Inductive Switching Energy Loss vs. Junction Temperature**

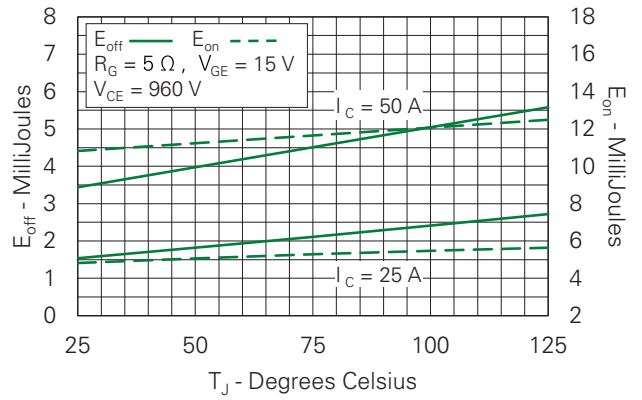

**Fig. 15. Inductive Turn-off Switching Times vs. Gate Resistance**

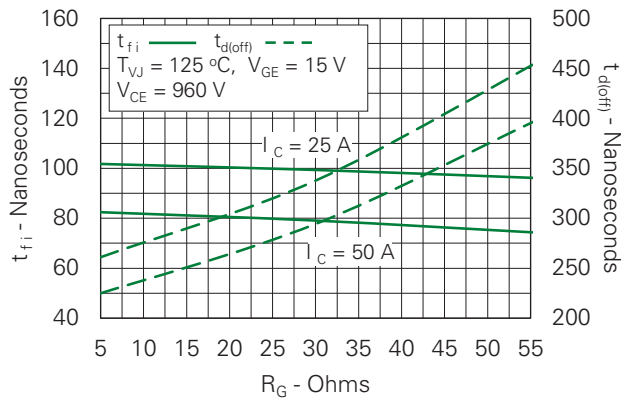

**Fig. 16. Inductive Turn-off Switching Times vs. Collector Current**

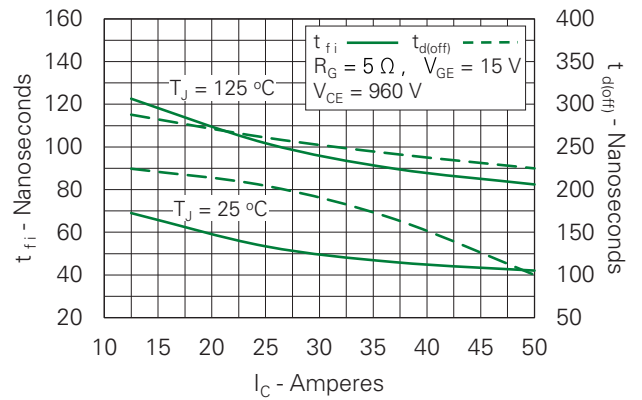

**Fig. 17. Inductive Turn-off Switching Times vs. Junction Temperature**

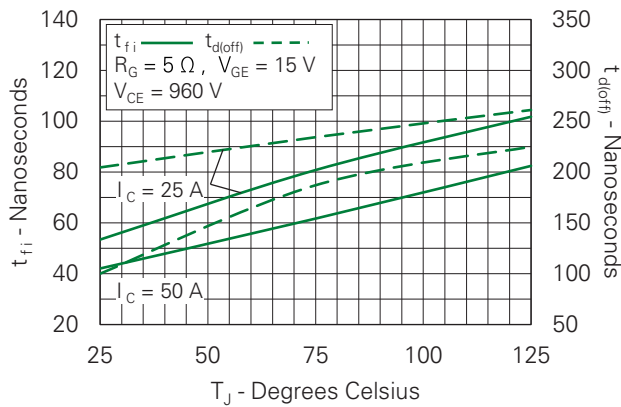

**Fig. 18. Inductive Turn-on Switching Times vs. Gate Resistance**

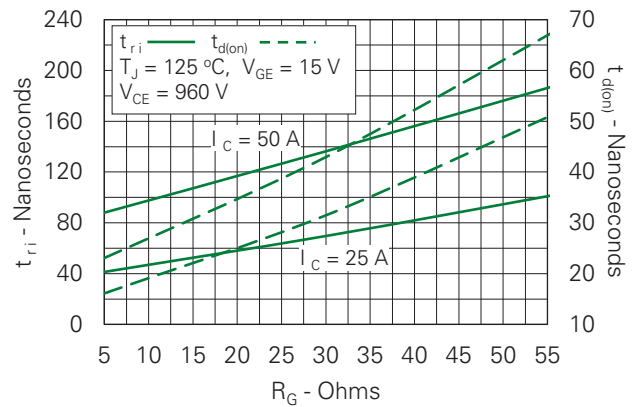

**Fig. 19. Inductive Turn-on Switching Times vs. Collector Current**

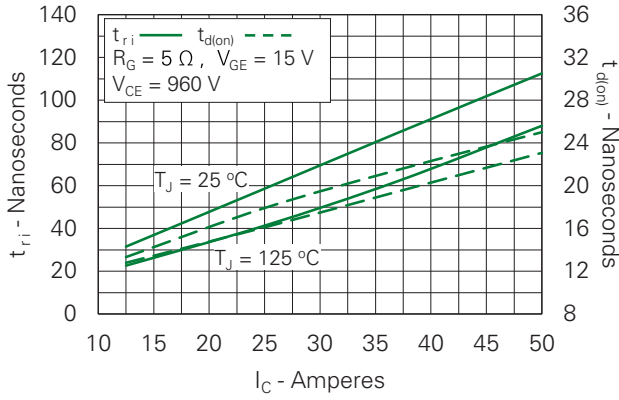

**Fig. 20. Inductive Turn-on Switching Times vs. Junction Temperature**

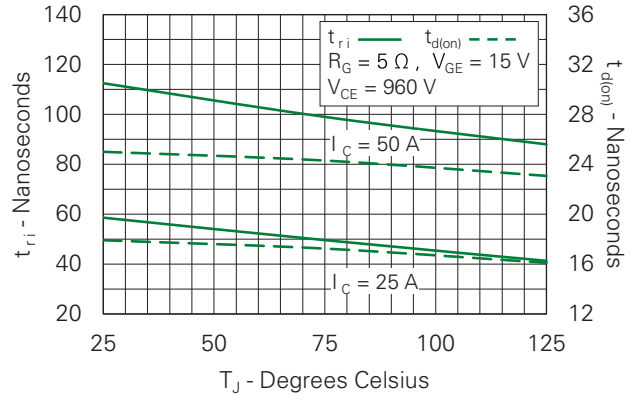

**Fig. 21. Diode Forward Characteristics**

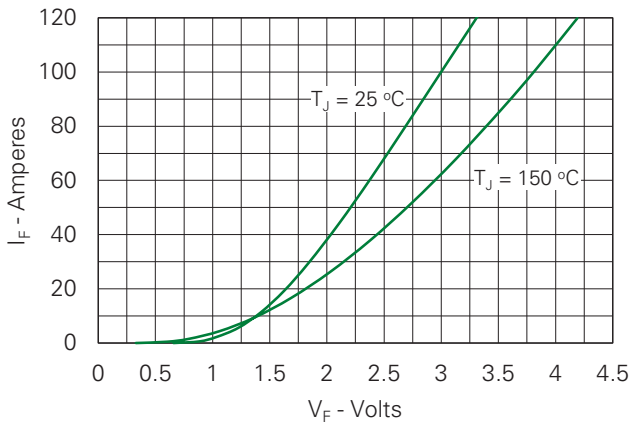

**Fig. 22. Reverse Recovery Charge vs. -diF/dt**

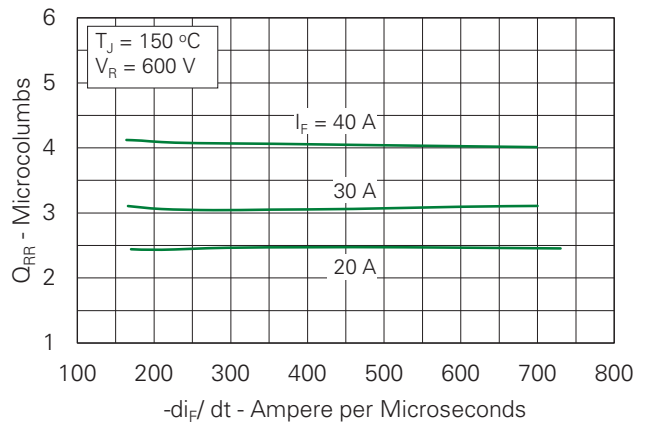

**Fig. 23. Reverse Recovery Current vs. -diF/dt**

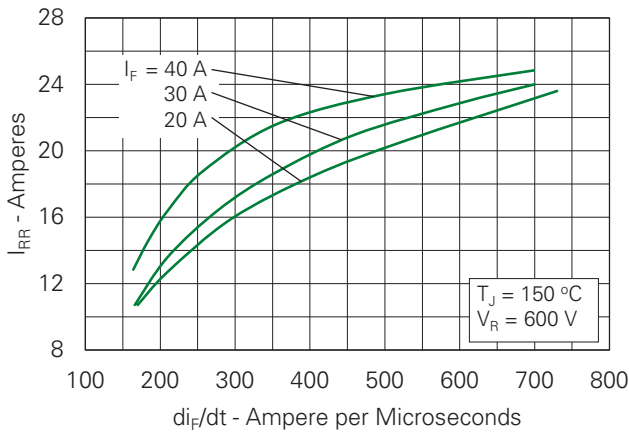

**Fig. 24. Reverse Recovery Time vs. -diF/dt**

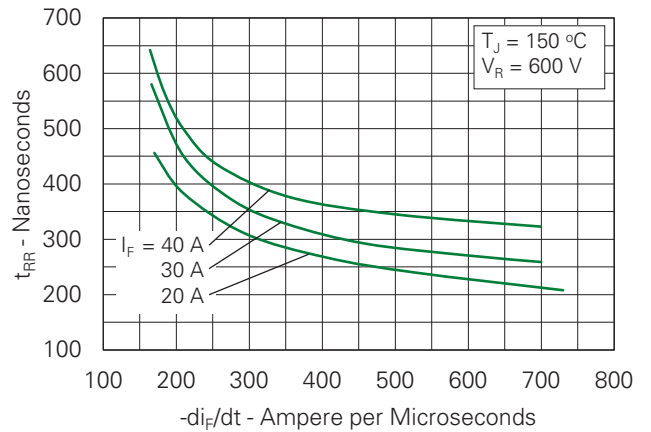

**Fig. 25. Dynamic Parameters  $Q_{RR}$ ,  $I_{RR}$  vs. Junction Temperature**

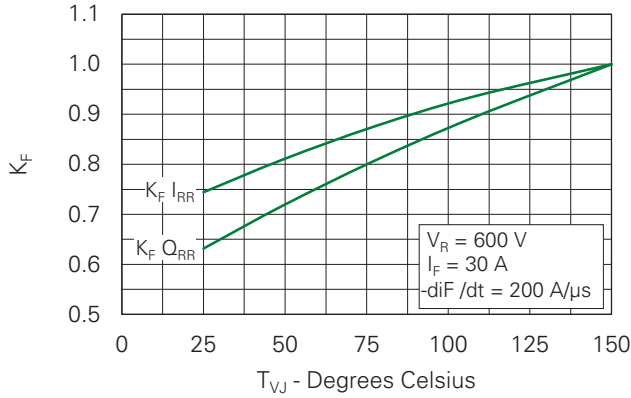

**Fig. 26. Maximum Transient Thermal Impedance (Diode)**

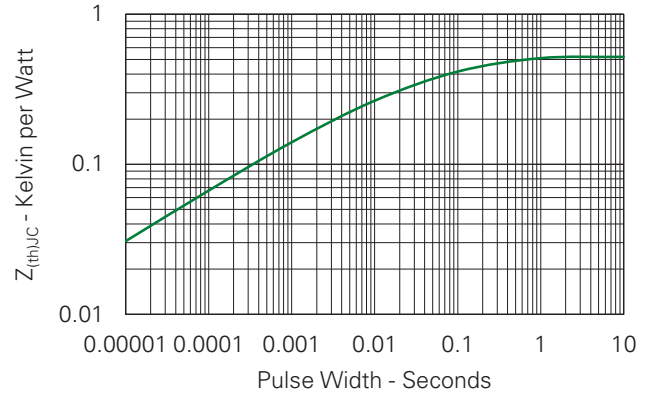

**Part Outline Drawing (TO-247-3L)**

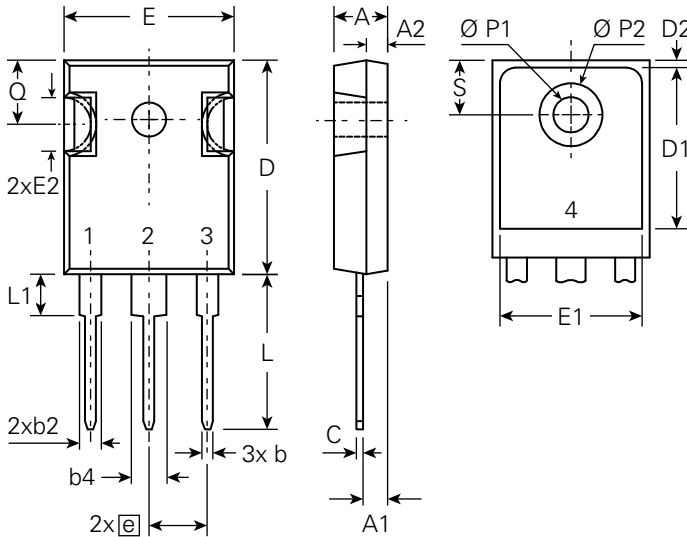

Symbol	Inches			Millimeters		
	Min.	Typical	Max.	Min.	Typical	Max
A	0.185	-	0.209	4.70	-	5.30
A1	0.087	-	0.102	2.21	-	2.59
A2	0.059	-	0.098	1.50	-	2.49
b	0.039	-	0.055	0.99	-	1.40
b2	0.065	-	0.094	1.65	-	2.39
b4	0.102	-	0.135	2.59	-	3.43
C	0.015	-	0.035	0.38	-	0.89
D	0.819	-	0.844	20.79	-	21.45
D1	0.515	-	-	13.07	-	-
D2	0.020	-	0.053	0.51	-	1.35
E	0.609	-	0.639	15.48	-	16.24
E1	0.530	-	-	13.45	-	-
E2	0.170	-	0.216	4.31	-	5.48
e	0.215 BSC			5.45 BSC		
L	0.780	-	0.799	19.80	-	20.30
L1	-	-	0.177	-	-	4.49
Ø P1	0.140	-	0.144	3.55	-	3.65
Ø P2	-	-	0.291	-	-	7.39
Q	0.212	-	0.244	5.38	-	6.19
S	0.242 BSC			6.14 BSC		

**Disclaimer Notice** - Information furnished is believed to be accurate and reliable. However, users should independently evaluate the suitability of and test each product selected for their own applications. Littelfuse products are not designed for, and may not be used in, all applications. Read complete Disclaimer Notice at <http://www.littelfuse.com/disclaimer-electronics>.