

IXYN110N120B4H1

1200 V, 110 A XPT™ Gen4 IGBT with Sonic Diode

Extreme Light Punch Through IGBT for 5–30 kHz Switching

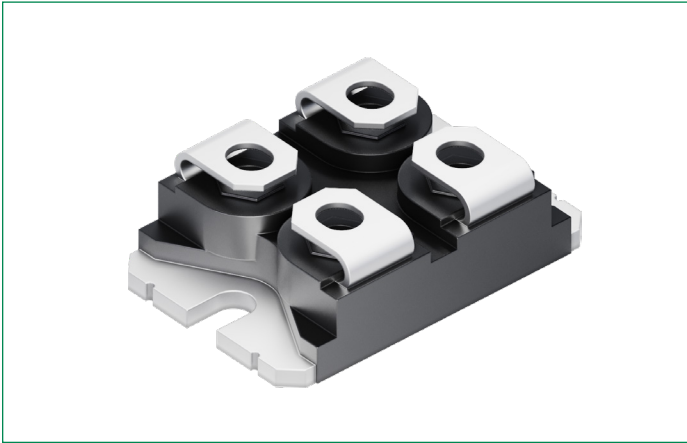

Pinout Diagram (SOT-227B)

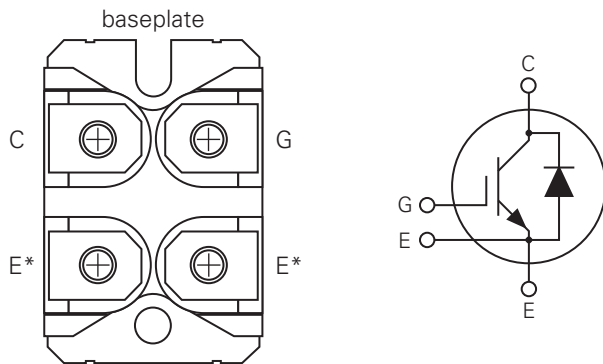

G: Gate; **C:** Collector; **E:** Emitter; **baseplate:** Isolated
 *Either emitter terminal can be used as Main or Kelvin Emitter

Description:

Developed using our proprietary XPT™ thin-wafer technology and state-of-the-art Trench IGBT process, these devices feature reduced thermal resistance, low energy losses, fast switching, low tail current, and high current densities.

Features & Benefits:

- Optimized for 5–30kHz Switching
- miniBLOC, with Aluminium Nitride Isolation
- 2500V~ Isolation Voltage
- High Current Handling Capability
- Positive Thermal Coefficient of $V_{CE(sat)}$
- High Power Density
- Low Gate Drive Requirement
- International Standard Package
- Anti-Parallel Sonic Diode

Applications:

- Power Inverters
- UPS
- Motor Drives
- SMPS
- PFC Circuits
- Battery Chargers
- Welding Machines

Product Summary

Characteristic	Value	Unit
V_{CES}	1200	V
I_{C110}	110	A
$V_{CE(sat)}$	2.10	V
$t_{fi(typ)}$	130	ns

Maximum Ratings

Symbol	Characteristic	Conditions	Value	Unit
V_{CES}	Collector-Emitter Voltage	$T_{VJ} = 25\text{ °C to }175\text{ °C}$	1200	V
V_{GES}	Gate-Emitter Voltage	Continuous	± 20	V
V_{GEM}	Transient Gate-Emitter Voltage	Transient	± 30	V
I_{C25}	Continuous Collector Current	$T_C = 25\text{ °C}$	218	A
I_{LRMS}	Terminal Current Limit	–	200	A
I_{C110}	Continuous Collector Current	$T_C = 110\text{ °C}$	110	A
I_{F110}	Diode Forward Current	$T_C = 110\text{ °C}$	74	A
I_{CM}	Pulsed Collector Current	$T_C = 25\text{ °C}, 1\text{ ms}$	820	A
SSOA (RBSOA)	Switching Safe Operating Area (Reverse Biased Safe Operating Area)	$V_{GE} = 15\text{ V}, T_{VJ} = 150\text{ °C}, R_G = 2\ \Omega,$ $I_{CM} = 0.8 \times V_{CES}$	220	A
P_C	Collector Power Dissipation	$T_C = 25\text{ °C}$	830	W
T_{VJ}	Virtual Junction Temperature	–	–55 to 175	°C
T_{stg}	Storage Temperature	–	–55 to 175	°C
V_{ISOL}	Isolation Voltage	50/60 Hz, $I_{ISOL} \leq 1\text{ mA}, t = 1\text{ min}$	2500	V~
		50/60 Hz, $I_{ISOL} \leq 1\text{ mA}, t = 1\text{ s}$	3000	
M_d	Mounting Torque	–	1.5 / 13	Nm/lb.in
	Terminal Connection Torque	–	1.3 / 11.5	
W	Weight	–	30	g

Thermal Characteristics

Symbol	Characteristic	Conditions	Value			Unit
			Min.	Typ.	Max.	
$R_{th, JC}$	Thermal Resistance, junction-to-case, IGBT	–	–	–	0.18	K/W
$R_{th, CS}$	Thermal Resistance, case-to-heat sink	–	–	0.05	–	K/W

Electrical Characteristics – Static ($T_{VJ} = 25\text{ °C}$ unless otherwise specified)

Symbol	Characteristic	Conditions	Value			Unit
			Min.	Typ.	Max.	
BV_{CES}	Collector-Emitter Breakdown Voltage	$I_C = 250\ \mu\text{A}, V_{GE} = 0\text{ V}$	1200	–	–	V
$V_{GE(th)}$	Gate-Emitter Threshold Voltage	$I_C = 3\text{ mA}, V_{CE} = V_{GE}$	4.5	–	6.5	V
I_{CES}	Zero Gate Voltage Collector Current	$V_{CE} = V_{CES}, V_{GE} = 0\text{ V}$	–	–	50	μA
		$V_{CE} = V_{CES}, V_{GE} = 0\text{ V}, T_{VJ} = 125\text{ °C}$	–	–	7	mA
I_{GES}	Gate-Emitter Leakage Current	$V_{CE} = 0\text{ V}, V_{GE} = \pm 20\text{ V}$	–	–	± 100	nA
$V_{CE(sat)}$	Collector-Emitter Saturation Voltage ¹	$I_C = I_{C110}, V_{GE} = 15\text{ V}$	–	1.66	2.10	V
		$I_C = I_{C110}, V_{GE} = 15\text{ V}, T_{VJ} = 150\text{ °C}$	–	1.95	–	V

Note 1: Pulse test, $t \leq 300\ \mu\text{s}$, duty cycle, $d \leq 2\%$

Electrical Characteristics – Dynamic ($T_{VJ} = 25\text{ °C}$ unless otherwise specified)

Symbol	Characteristic	Conditions	Value			Unit	
			Min.	Typ.	Max.		
g_{fs}	Transconductance ¹	$I_C = 55\text{ A}, V_{CE} = 10\text{ V}$	40	68	–	S	
C_{ies}	Input Capacitance	$V_{CE} = 25\text{ V}, V_{GE} = 0\text{ V}, f = 1\text{ MHz}$	–	5460	–	pF	
C_{oes}	Output Capacitance		–	480	–		
C_{res}	Reverse Transfer Capacitance		–	220	–		
$Q_{g(on)}$	Total Gate Charge	$I_C = I_{C110}, V_{GE} = 15\text{ V}, V_{CE} = 0.5 \times V_{CES}$	–	340	–	nC	
Q_{ge}	Gate-Emitter Charge		–	52	–		
Q_{gc}	Gate-Collector Charge		–	144	–		
$t_{d(on)}$	Turn-on Delay Time ²	Inductive Load, $V_{GE} = 15\text{ V},$ $V_{CE} = 0.5 \times V_{CES},$ $I_C = 50\text{ A},$ $R_{G(ext)} = 2\ \Omega$	$T_{VJ} = 25\text{ °C}$	–	45	–	ns
			$T_{VJ} = 150\text{ °C}$	–	34	–	
t_{ri}	Turn-on Rise Time ²		$T_{VJ} = 25\text{ °C}$	–	50	–	ns
			$T_{VJ} = 150\text{ °C}$	–	38	–	
E_{on}	Turn-on Energy ²		$T_{VJ} = 25\text{ °C}$	–	3.60	–	mJ
			$T_{VJ} = 150\text{ °C}$	–	4.95	–	
$t_{d(off)}$	Turn-off Delay Time ²		$T_{VJ} = 25\text{ °C}$	–	390	–	ns
			$T_{VJ} = 150\text{ °C}$	–	440	–	
t_{fi}	Turn-off Fall Time ²		$T_{VJ} = 25\text{ °C}$	–	130	–	ns
			$T_{VJ} = 150\text{ °C}$	–	210	–	
E_{off}	Turn-off Energy ²	$T_{VJ} = 25\text{ °C}$	–	3.85	–	mJ	
		$T_{VJ} = 150\text{ °C}$	–	6.45	–		

Note 1: Pulse test, $t \leq 300\ \mu\text{s}$, duty cycle, $d \leq 2\%$

Note 2: Switching times and energy losses may increase for higher $V_{CE(clamp)}$, T_{VJ} , or R_G .

Reverse Sonic Diode (FRD) ($T_{VJ} = 25\text{ °C}$ unless otherwise specified)

Symbol	Characteristic	Conditions	Value			Unit
			Min.	Typ.	Max.	
V_F	Diode Forward Voltage ¹	$I_F = 100\text{ A}, V_{GE} = 0\text{ V}$	–	2.20	2.70	V
		$I_F = 100\text{ A}, V_{GE} = 0\text{ V}, T_{VJ} = 150\text{ °C}$	–	2.15	–	
I_{RM}	Reverse Recovery Current	$I_F = 50\text{ A}, V_{GE} = 0\text{ V}, T_{VJ} = 150\text{ °C}$	–	43	–	A
t_{rr}	Reverse Recovery Time	$-di_F/dt = 750\text{ A}/\mu\text{s}, V_R = 600\text{ V}$	–	270	–	ns
$R_{th, JC}$	Thermal Resistance, junction-to-case	–	–	–	0.41	K/W

Note 1: Pulse test, $t \leq 300\ \mu\text{s}$, duty cycle, $d \leq 2\%$

Characteristic Curves

Fig. 1. Output Characteristics @ $T_{VJ} = 25\text{ }^\circ\text{C}$

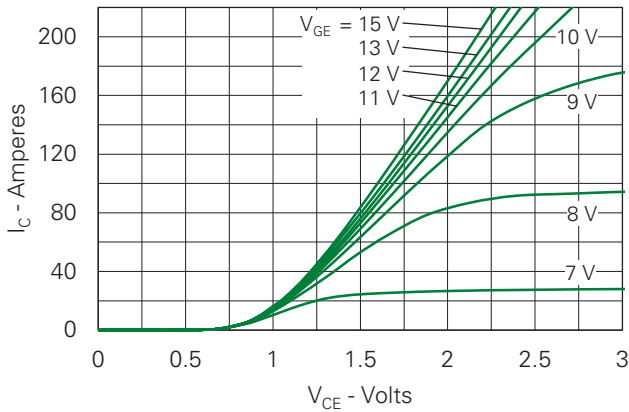

Fig. 2. Extended Output Characteristics @ $T_{VJ} = 25\text{ }^\circ\text{C}$

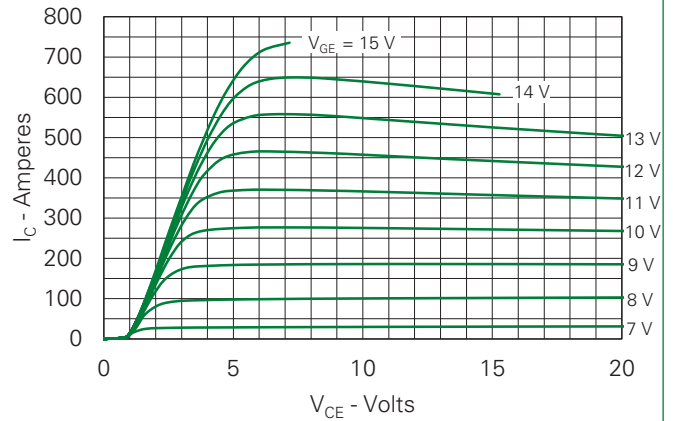

Fig. 3. Output Characteristics @ $T_{VJ} = 150\text{ }^\circ\text{C}$

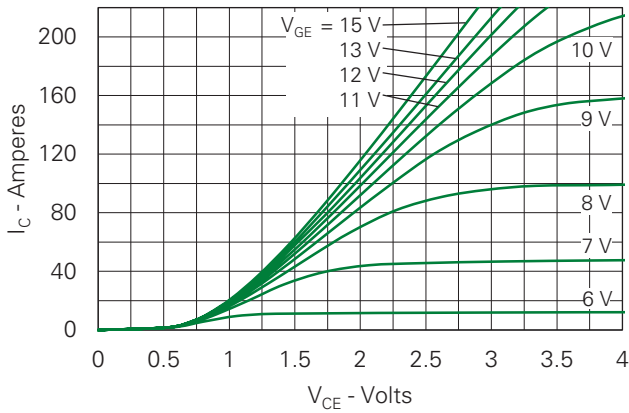

Fig. 4. Dependence of $V_{CE(sat)}$ on Junction Temperature

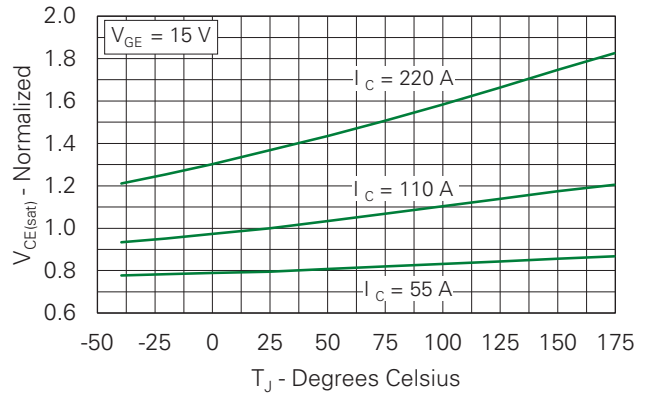

Fig. 5. Collector-to-Emitter Voltage vs. Gate-to-Emitter Voltage

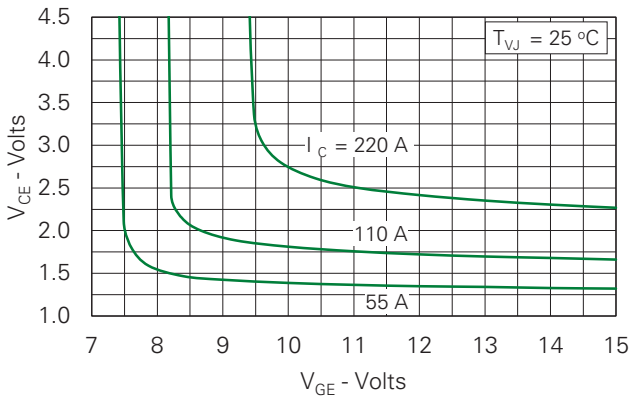

Fig. 6. Input Admittance

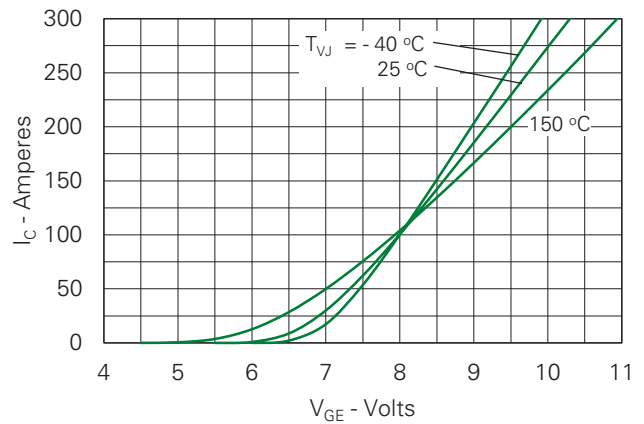

Fig. 7. Transconductance

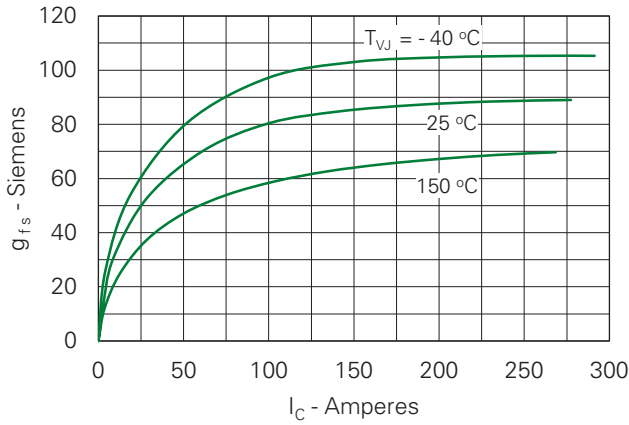

Fig. 8. Gate Charge

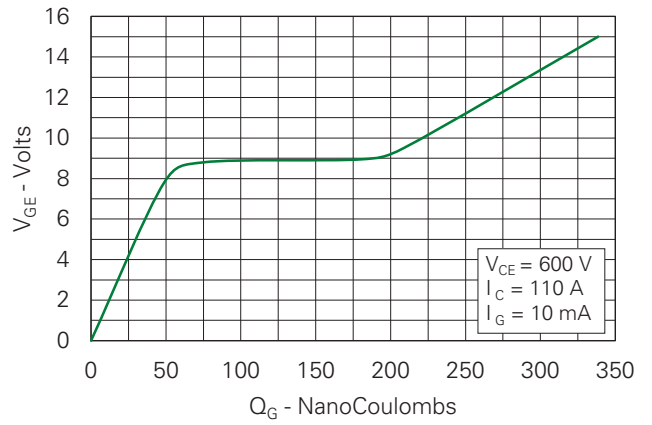

Fig. 9. Capacitance

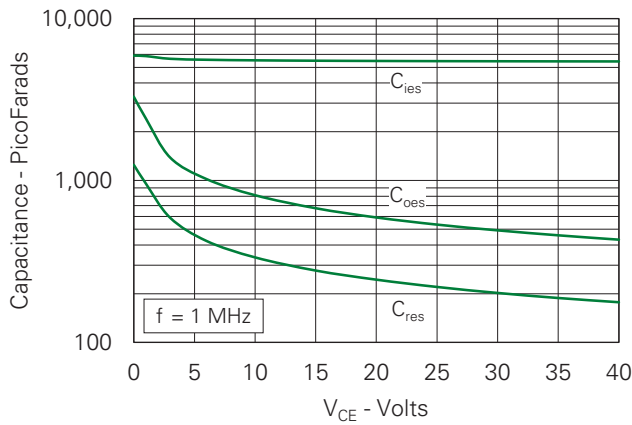

Fig. 10. Reverse-Bias Safe Operating Area

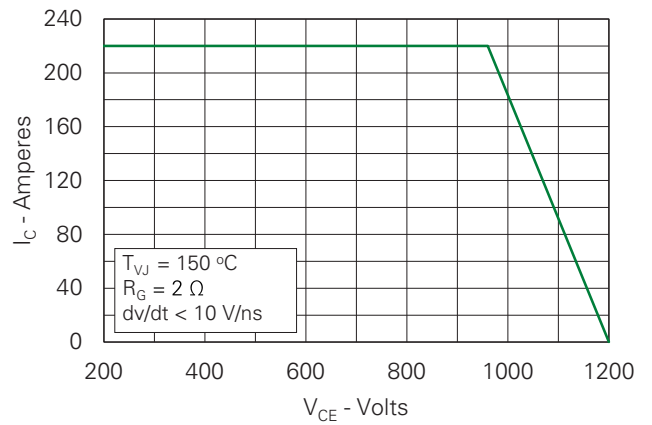

Fig. 11. Maximum Transient Thermal Impedance

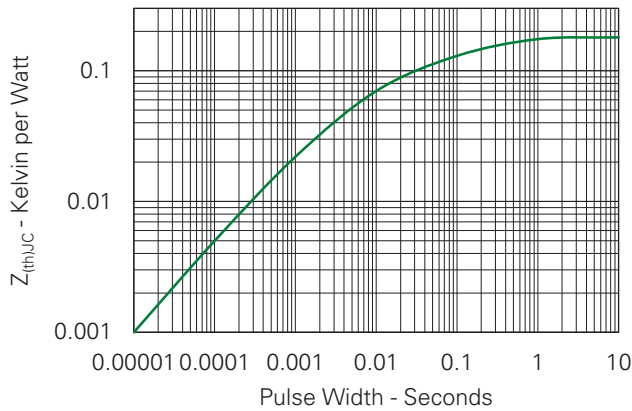

Fig. 12. Inductive Switching Energy Loss vs. Collector Current

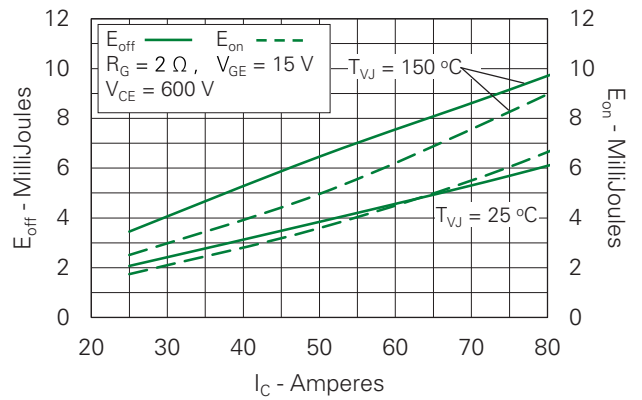

Fig. 13. Inductive Switching Energy Loss vs. Collector-Emitter Voltage

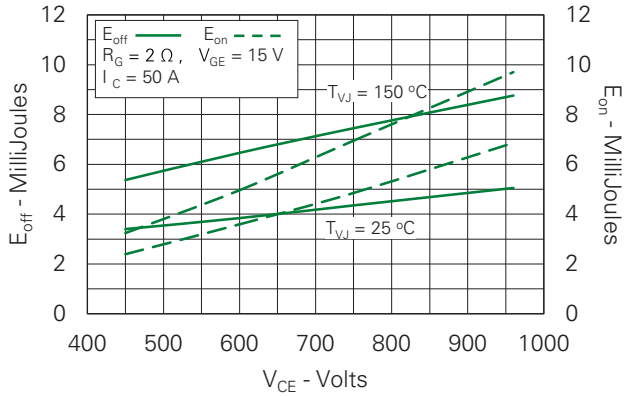

Fig. 14. Inductive Switching Energy Loss vs. Gate Resistance

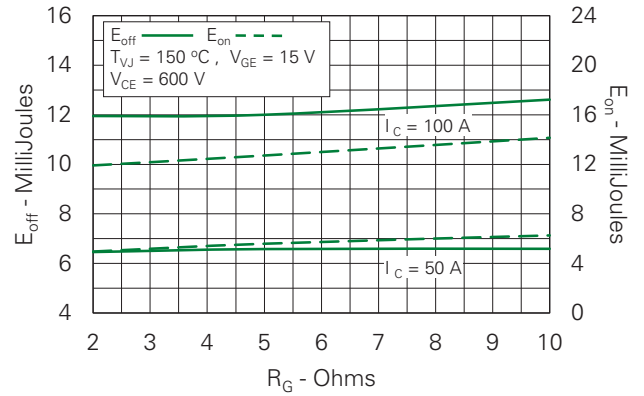

Fig. 15. Inductive Switching Energy Loss vs. Junction Temperature

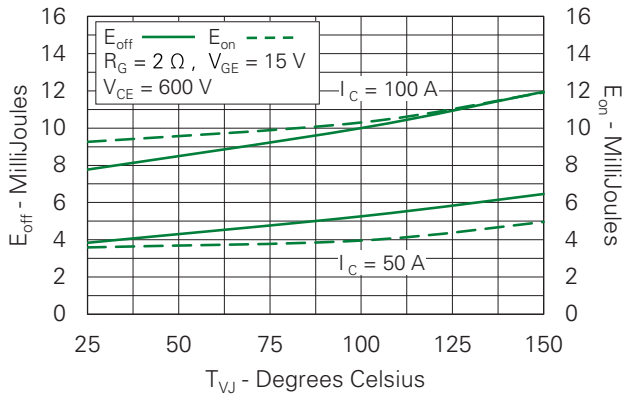

Fig. 16. Inductive Turn-off Switching Times vs. Gate Resistance

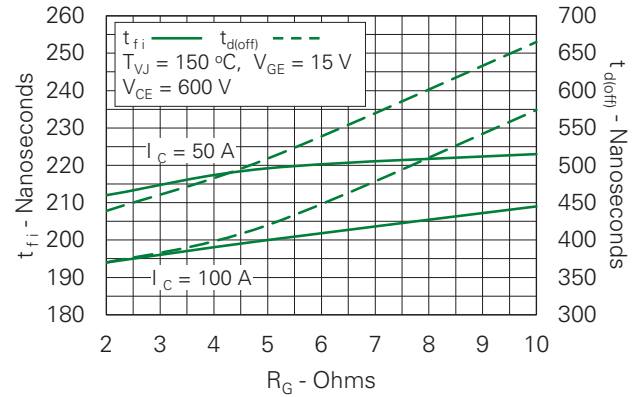

Fig. 17. Inductive Turn-off Switching Times vs. Collector Current

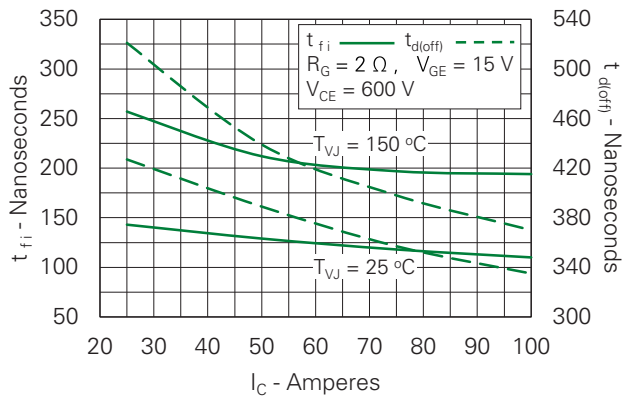

Fig. 18. Inductive Turn-off Switching Times vs. Junction Temperature

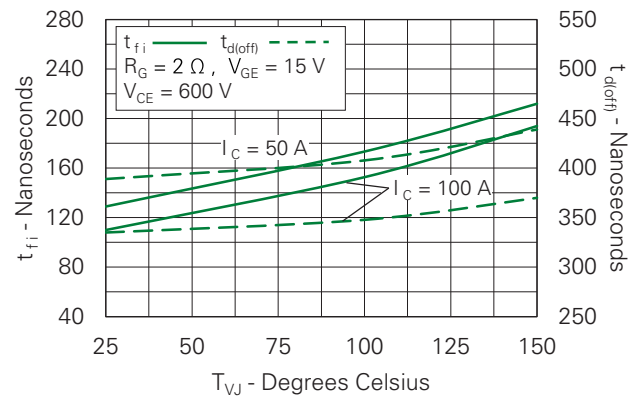

Fig. 19. Inductive Turn-on Switching Times vs. Gate Resistance

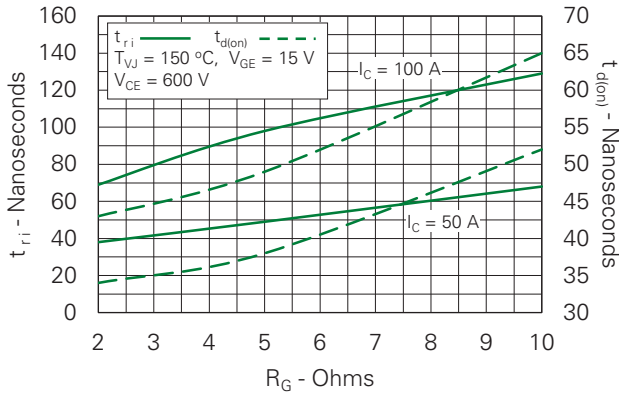

Fig. 20. Inductive Turn-on Switching Times vs. Collector Current

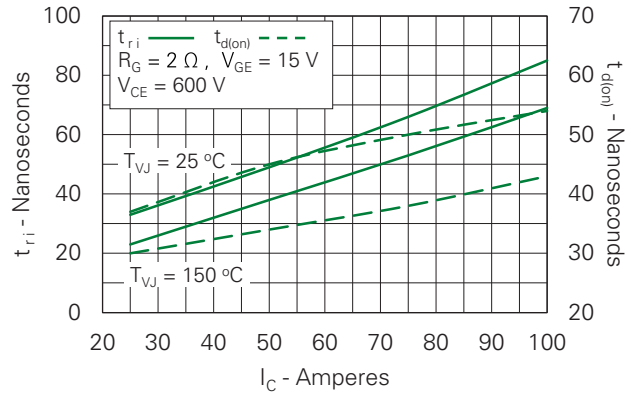

Fig. 21. Inductive Turn-on Switching Times vs. Junction Temperature

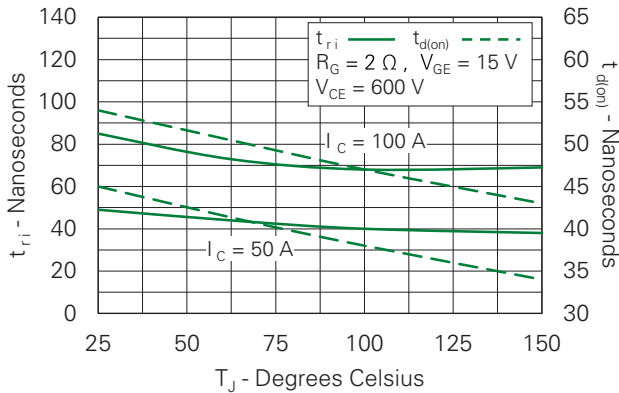

Fig. 22. Maximum Peak Load Current vs. Frequency

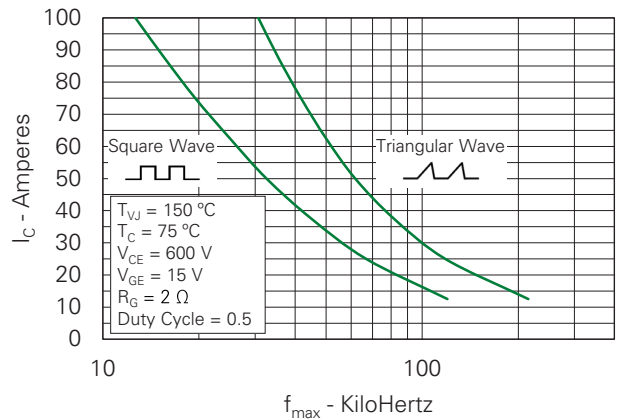

Fig. 23. Diode Forward Characteristics

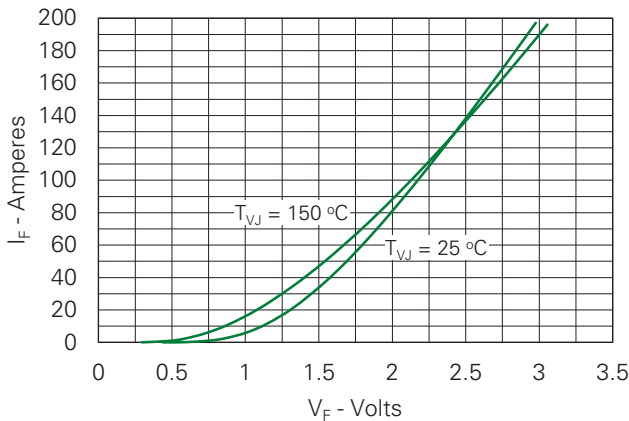

Fig. 24. Reverse Recovery Charge vs. -di_F/dt

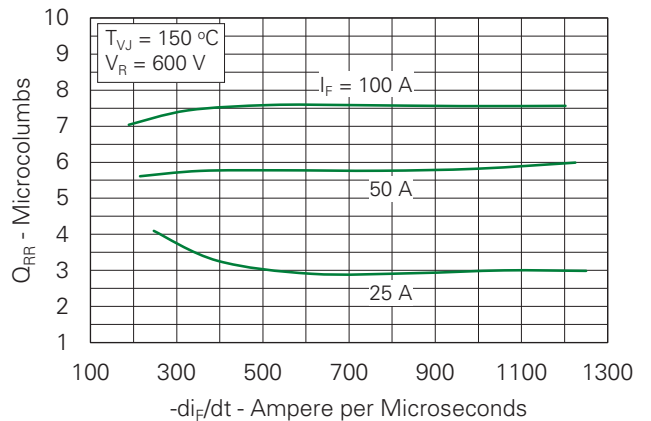

Fig. 25 Reverse Recovery Current vs. $-di_F/dt$

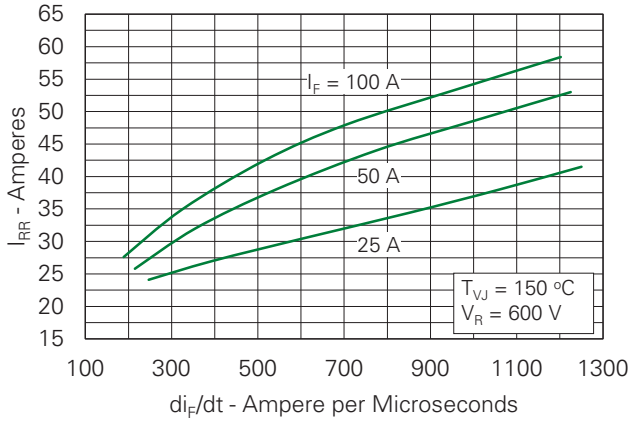

Fig. 26. Reverse Recovery Time vs. $-di_F/dt$

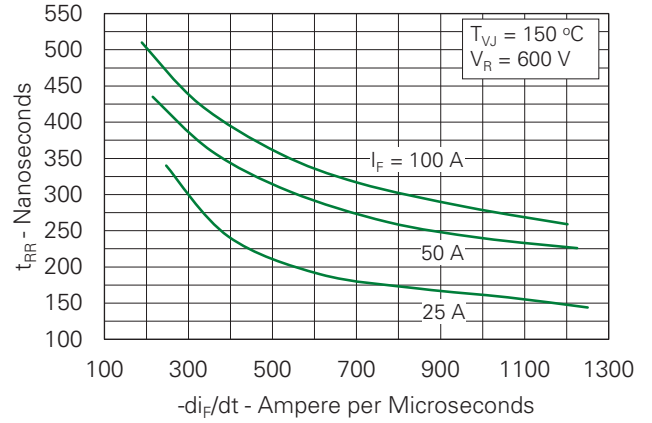

Fig. 27. Dynamic Parameters Q_{RR} , I_{RR} vs. Junction Temperature

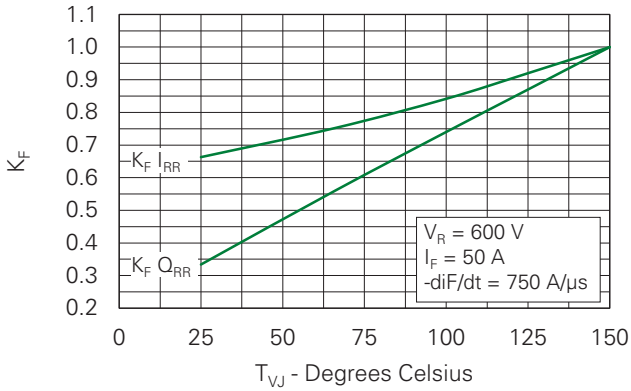
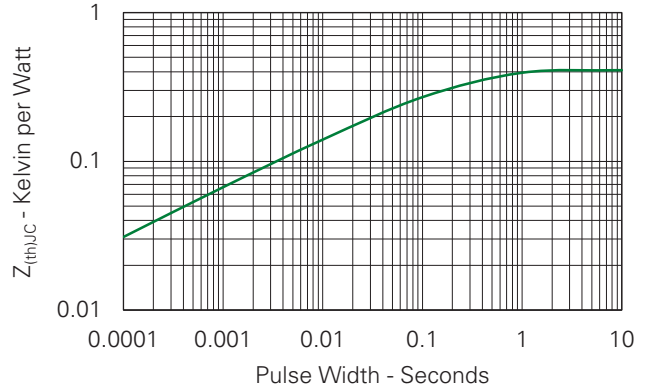
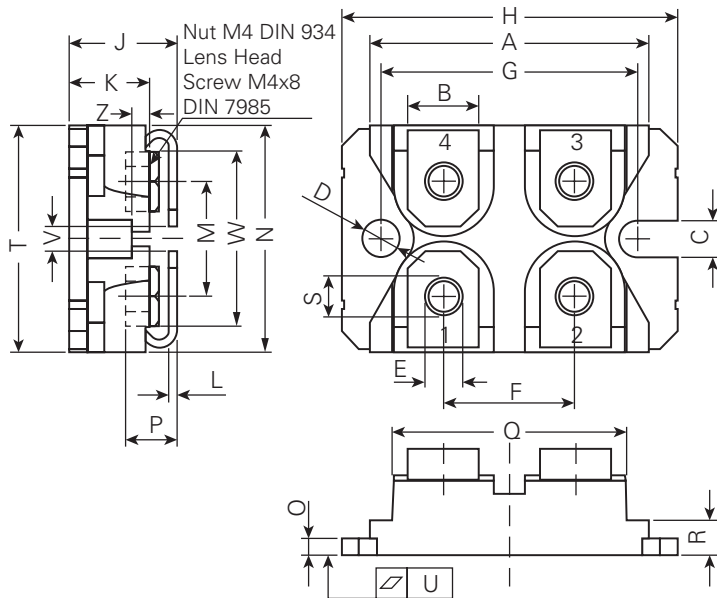

Fig. 28. Maximum Transient Thermal Impedance (Diode)



Part Outline Drawing (SOT-227B)



Symbol	Inches			Millimeters		
	Min.	Typical	Max.	Min.	Typical	Max
A	1.240	-	1.255	31.50	-	31.88
B	0.307	-	0.323	7.80	-	8.20
C	0.161	-	0.169	4.09	-	4.29
D	0.161	-	0.169	4.09	-	4.29
E	0.161	-	0.169	4.09	-	4.29
F	0.587	-	0.595	14.91	-	15.11
G	1.186	-	1.193	30.12	-	30.30
H	1.488	-	1.505	37.80	-	38.23
J	0.460	-	0.481	11.68	-	12.22
K	0.351	-	0.378	8.92	-	9.60
L	0.029	-	0.033	0.74	-	0.84
M	0.492	-	0.516	12.50	-	13.10
N	0.990	-	1.001	25.15	-	25.42
O	0.077	-	0.084	1.95	-	2.13
P	0.195	-	0.244	4.95	-	6.20
Q	1.045	-	1.059	26.54	-	26.90
R	0.155	-	0.174	3.94	-	4.42
S	0.179	-	0.191	4.55	-	4.85
T	0.968	-	0.994	24.59	-	25.25
U	-0.002	-	0.004	-0.05	-	0.10
V	0.126	-	0.217	3.20	-	5.50
W	0.780	-	0.830	19.81	-	21.08
Z	0.098	-	0.106	2.50	-	2.70

Disclaimer Notice - Information furnished is believed to be accurate and reliable. However, users should independently evaluate the suitability of and test each product selected for their own applications. Littelfuse products are not designed for, and may not be used in, all applications. Read complete Disclaimer Notice at <http://www.littelfuse.com/disclaimer-electronics>.