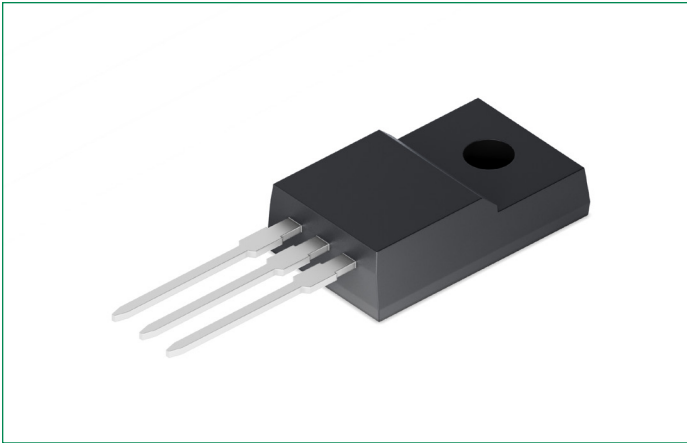


IXFP38N30X3M

300 V, 50 mΩ X3-Class HiPerFET™ Power MOSFET



Features

- International Standard Package
- Plastic Overmolded Tab
- Low $R_{DS(on)}$ and Q_G
- Avalanche Rated
- 2500 V~ Electrical Isolation
- Low Package Inductance

Advantages

- High Power Density
- Easy to Mount
- Space Savings

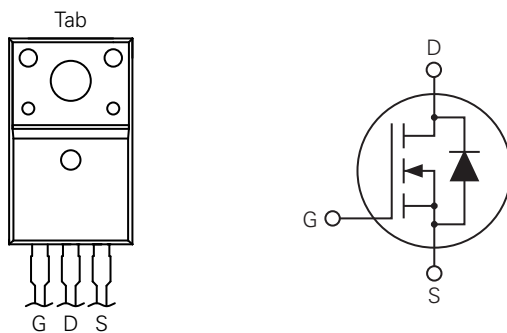
Applications

- Switch-Mode and Resonant-Mode Power Supplies
- DC-DC Converters
- PFC Circuits
- AC and DC Motor Drives
- Robotics and Servo Controls

Product Summary

Characteristics	Value	Unit
V_{DSS}	300	V
I_{D25}	38	A
$R_{DS(on),max}$	≤ 50	mΩ

Pinout Diagram (Overmolded TO-220)



G: Gate; **D:** Drain; **S:** Source; **Tab:** Electrically Isolated

Maximum Ratings

Symbol	Characteristics	Conditions	Value	Units
V_{DSS}	Drain-Source Voltage	$T_J = 25^\circ\text{C}$ to 150°C	300	V
V_{DGR}	Drain-Gate Voltage	$T_J = 25^\circ\text{C}$ to 150°C , $R_{GS} = 1\text{ M}\Omega$	300	V
V_{GSS}	Gate-Source Voltage	Continuous	± 20	V
V_{GSM}		Transient	± 30	
I_{D25}	Drain Current	$T_C = 25^\circ\text{C}$, Limited by T_{JM}	38	A
I_{DM}		$T_C = 25^\circ\text{C}$, Pulse width limited by T_{JM}	60	
I_A	Avalanche Current	$T_C = 25^\circ\text{C}$	19	A
E_{AS}	Avalanche Energy	$T_C = 25^\circ\text{C}$	400	mJ
dv/dt	Reverse Diode dv/dt	$I_S \leq I_{DM}$, $V_{DD} \leq V_{DSS}$, $T_J \leq 150^\circ\text{C}$	50	V/ns
P_D	Power Dissipation	$T_C = 25^\circ\text{C}$	40	W
T_J	Operating Junction Temperature	–	–55 to +150	°C
T_{JM}	Maximum Junction Temperature	–	150	
T_{stg}	Storage Temperature	–	–55 to +150	
T_L	Maximum Lead Temperature for Soldering	1.6 mm (0.062 in.) from case for 10 s	300	°C
V_{ISOL}	Isolation Voltage	50/60 Hz, 1 Minute	2500	V~
M_d	Mounting Torque	–	1.13 / 10	Nm/lb.in
W	Weight	–	2.5	g

Thermal Characteristics

Symbol	Characteristic	Value			Unit
		Min.	Typ.	Max.	
$R_{th, JC}$	Thermal Resistance, junction-to-case	–	–	3.1	°C/W
$R_{th, CS}$	Thermal Resistance, case-to-heat sink	–	0.50	–	°C/W

Electrical Characteristics – Static ($T_J = 25^\circ\text{C}$ unless otherwise specified)

Symbol	Characteristic	Conditions	Value			Unit
			Min.	Typ.	Max.	
BV_{DSS}	Drain-Source Breakdown Voltage	$I_D = 1\text{ mA}$, $V_{GS} = 0\text{ V}$	300	–	–	V
$V_{GS(th)}$	Gate Threshold Voltage	$I_D = 1\text{ mA}$, $V_{DS} = V_{GS}$	2.5	–	4.5	V
I_{GSS}	Gate-Source Leakage Current	$V_{DS} = 0\text{ V}$, $V_{GS} = \pm 20\text{ V}$	–	–	± 100	nA
I_{DSS}	Drain-Source Current	$V_{DS} = V_{DSS}$, $V_{GS} = 0\text{ V}$	–	–	25	μA
		$V_{DS} = V_{DSS}$, $V_{GS} = 0\text{ V}$, $T_J = 125^\circ\text{C}$	–	–	500	μA
$R_{DS(on)}$	Drain-Source On-Resistance ¹	$V_{GS} = 10\text{ V}$, $I_D = 19\text{ A}$	–	34	50	m Ω

Note 1: Pulse test, $t \leq 300\text{ }\mu\text{s}$, duty cycle, $d \leq 2\%$

Electrical Characteristics – Dynamic ($T_J = 25^\circ\text{C}$ unless otherwise specified)

Symbol	Characteristic	Conditions	Value			Unit
			Min.	Typ.	Max.	
g_{fs}	Transconductance ¹	$V_{DS} = 10\text{ V}, I_D = 19\text{ A}$	20	34	–	S
R_{GI}	Gate Input Resistance	–	–	1.9	–	Ω
C_{iss}	Input Capacitance	$V_{GS} = 0\text{ V}, V_{DS} = 25\text{ V}, f = 1\text{ MHz}$	–	2440	–	pF
C_{oss}	Output Capacitance		–	330	–	
C_{rss}	Reverse Transfer Capacitance		–	1.3	–	
$C_{o(er)}$	Effective Output Capacitance – Energy Related	$V_{GS} = 0\text{ V}, V_{DS} = 0.8 \times V_{DSS}$	–	130	–	pF
$C_{o(tr)}$	Effective Output Capacitance – Time Related		–	520	–	
$Q_{g(on)}$	Total Gate Charge	$V_{GS} = 10\text{ V}, V_{DS} = 0.5 \times V_{DSS},$ $I_D = 19\text{ A}$	–	35	–	nC
Q_{gs}	Gate-Source Charge		–	10	–	
Q_{gd}	Gate-Drain Charge		–	11	–	
$t_{d(on)}$	Turn-on Delay Time	Resistive Switching $V_{GS} = 10\text{ V}, V_{DS} = 0.5 \times V_{DSS},$ $I_D = 19\text{ A}, R_{G(ext)} = 10\ \Omega$	–	19	–	ns
t_r	Rise Time		–	23	–	
$t_{d(off)}$	Turn-off Delay Time		–	60	–	
t_f	Fall Time		–	14	–	

Note 1: Pulse test, $t \leq 300\ \mu\text{s}$, duty cycle, $d \leq 2\%$

Source-Drain Diode Characteristics ($T_J = 25^\circ\text{C}$ unless otherwise specified)

Symbol	Characteristic	Conditions	Value			Unit
			Min.	Typ.	Max.	
I_S	Continuous Diode Forward Current	$V_{GS} = 0\text{ V}$	–	–	38	A
I_{SM}	Diode Pulse Current	Repetitive, Pulse width limited by T_{JM}	–	–	152	A
V_{SD}	Diode Forward Voltage ¹	$I_F = I_S, V_{GS} = 0\text{ V}$	–	–	1.4	V
t_{rr}	Reverse Recovery Time	$I_F = 19\text{ A}, -di/dt = 100\text{ A}/\mu\text{s},$ $V_r = 100\text{ V}$	–	90	–	ns
Q_{rm}	Reverse Recovery Charge		–	330	–	nC
I_{rm}	Reverse Recovery Current		–	7.4	–	A

Note 1: Pulse test, $t \leq 300\ \mu\text{s}$, duty cycle, $d \leq 2\%$

Characteristic Curves

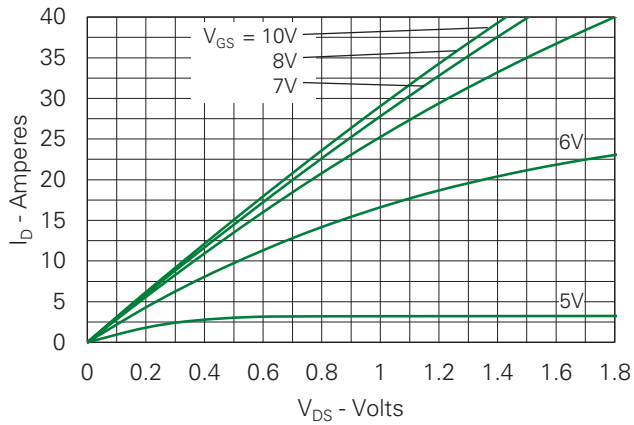
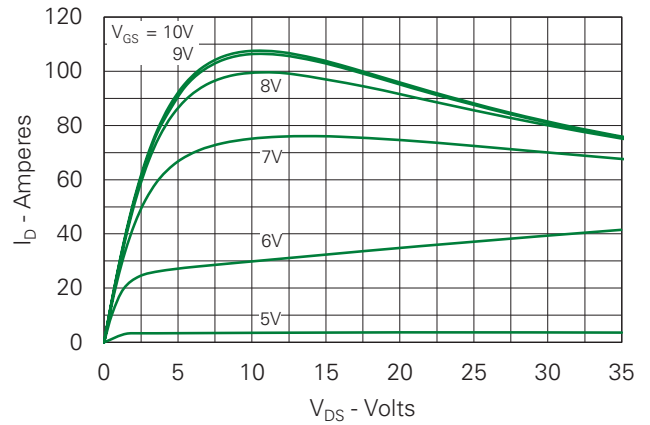
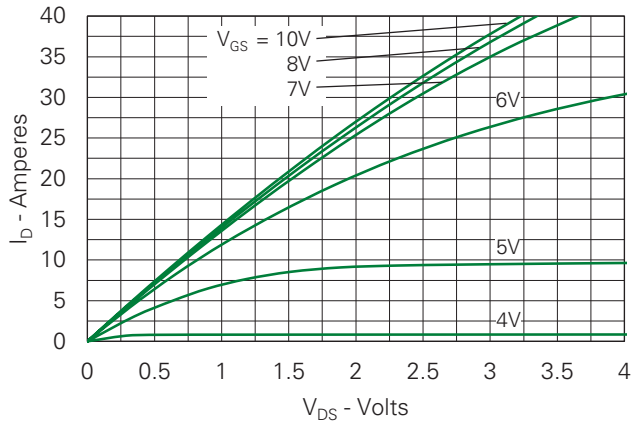
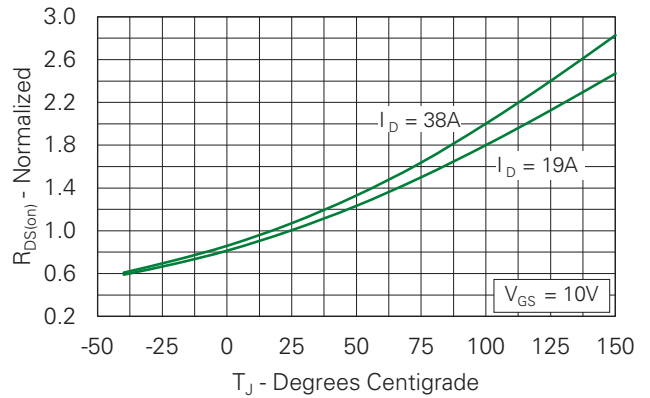
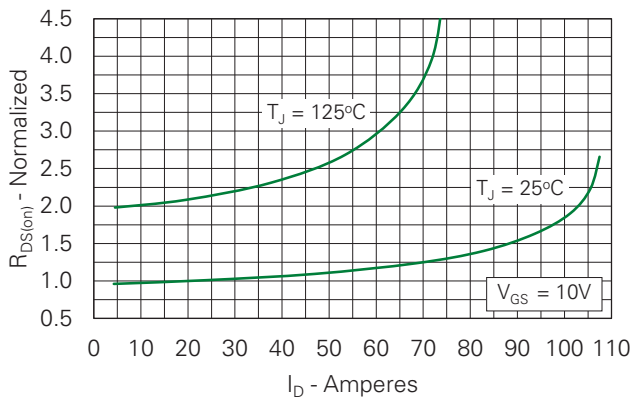
Fig. 1. Output Characteristics @ $T_J = 25^\circ\text{C}$ Fig. 2. Extended Output Characteristics @ $T_J = 25^\circ\text{C}$ Fig. 3. Output Characteristics @ $T_J = 125^\circ\text{C}$ Fig. 4. $R_{DS(on)}$ Normalized to $I_D = 19\text{A}$ Value vs. Junction TemperatureFig. 5. $R_{DS(on)}$ Normalized to $I_D = 19\text{A}$ Value vs. Drain Current

Fig. 6. Normalized Breakdown & Threshold Voltages vs. Junction Temperature

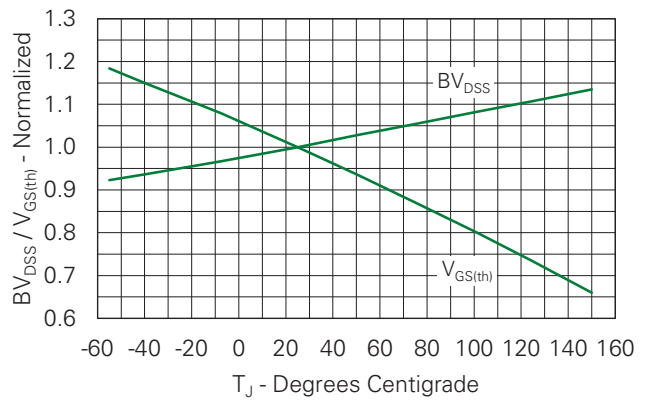


Fig. 7. Input Admittance

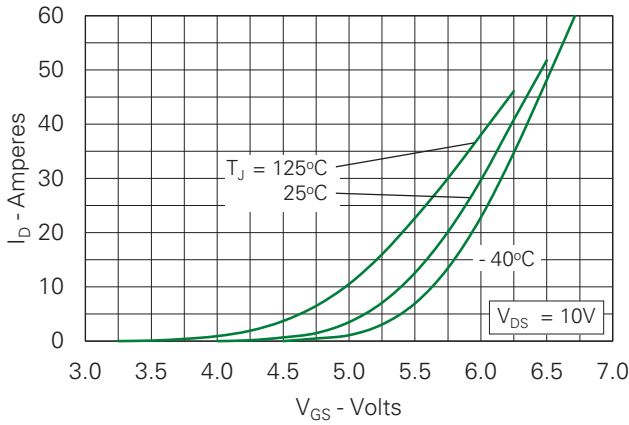


Fig. 8. Transconductance

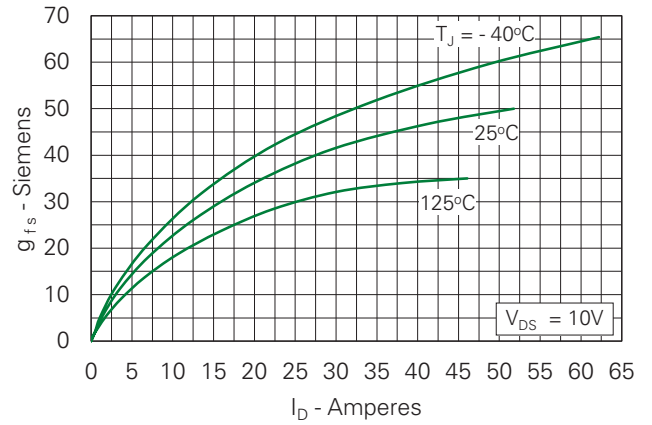


Fig. 9. Forward Voltage Drop of Intrinsic Diode

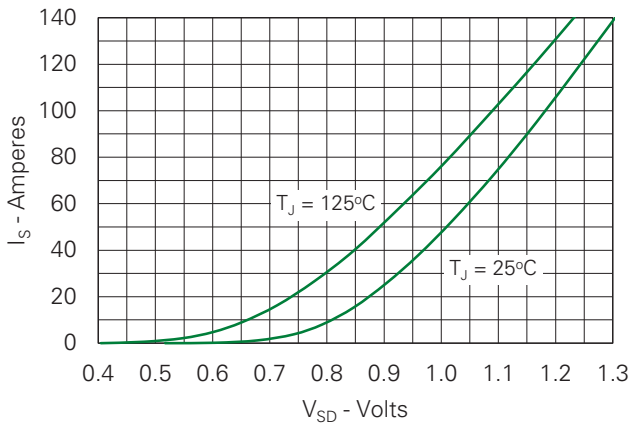


Fig. 10. Gate Charge

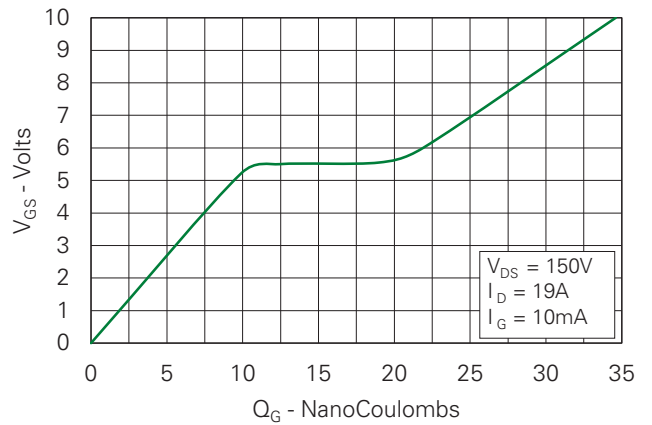


Fig. 11. Capacitance

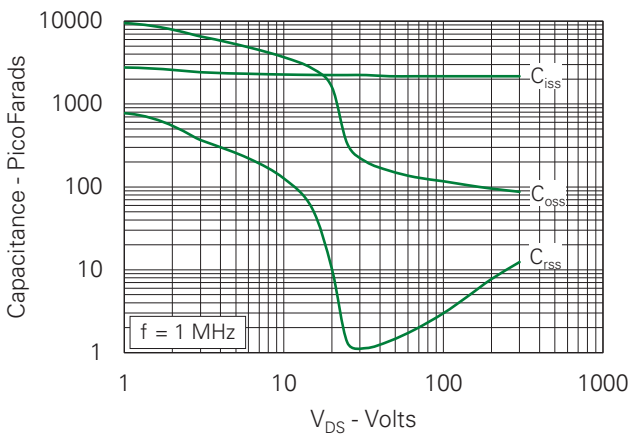


Fig. 12. Output Capacitance Stored Energy

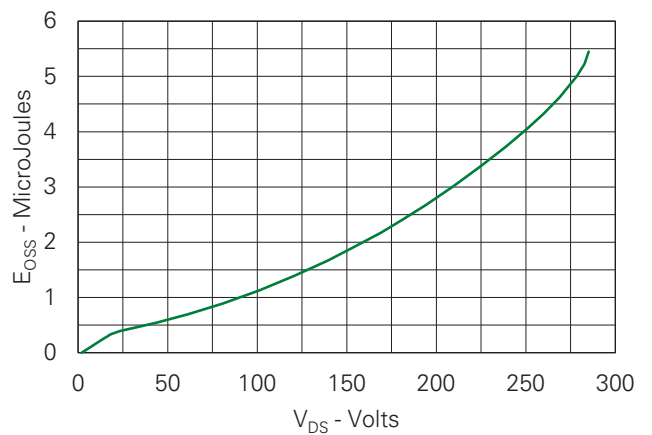


Fig. 13. Forward-Bias Safe Operating Area

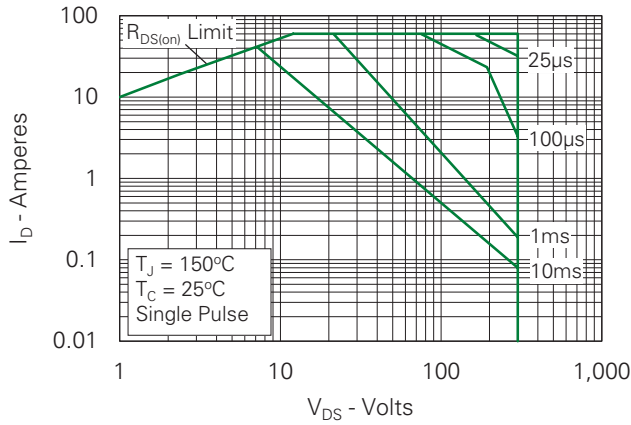
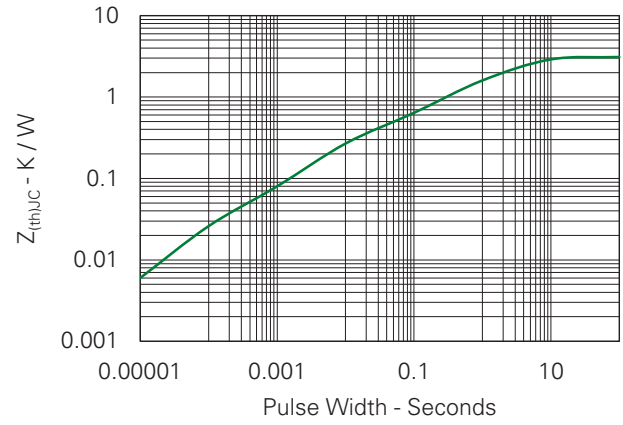
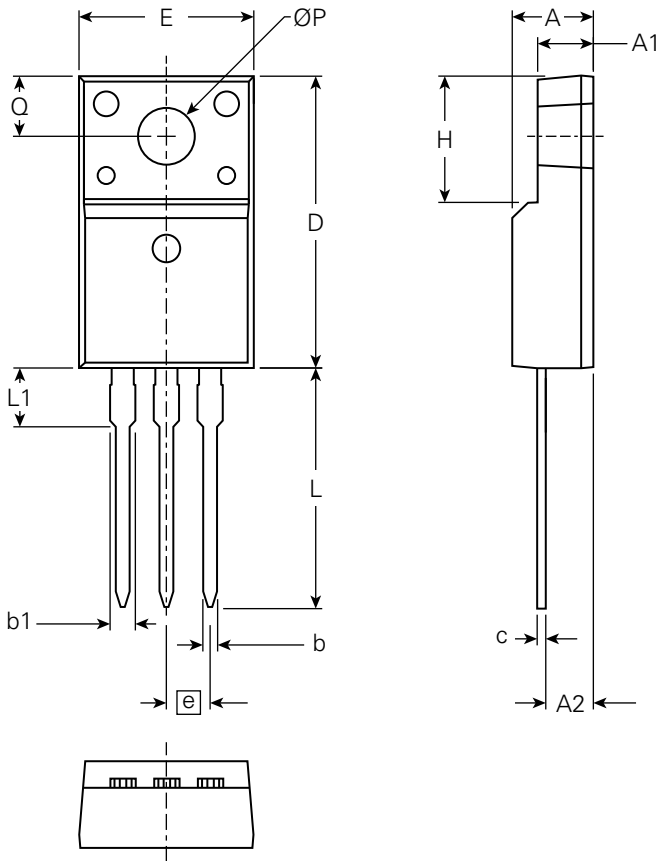


Fig. 14. Maximum Transient Thermal Impedance



Part Outline Drawing (Overmolded TO-220)



Symbol	Inches			Millimeters		
	Min.	Typical	Max.	Min.	Typical	Max.
A	0.177	-	0.193	4.50	-	4.90
A1	0.092	-	0.108	2.34	-	2.74
A2	0.101	-	0.117	2.56	-	2.96
b	0.028	-	0.035	0.70	-	0.90
b1	0.050	-	0.058	1.27	-	1.47
c	0.018	-	0.024	0.45	-	0.60
D	0.617	-	0.633	15.67	-	16.07
E	0.392	-	0.408	9.96	-	10.36
e	0.100 BSC			2.54 BSC		
H	0.255	-	0.271	6.48	-	6.88
L	0.499	-	0.523	12.68	-	13.28
L1	0.119	-	0.135	3.03	-	3.43
ØP	0.121	-	0.129	3.08	-	3.28
Q	0.126	-	0.134	3.20	-	3.40

Disclaimer Notice

Information furnished is believed to be accurate and reliable. However, users should independently evaluate the suitability of and test each product selected for their own applications. Littelfuse products are not designed for, and may not be used in, all applications. Read complete Disclaimer Notice at <http://www.littelfuse.com/disclaimer-electronics>.



Part of:

