



Rectifier Diode

Types W0880LC620 to W0880LC680

Absolute Maximum Ratings

	VOLTAGE RATINGS	MAXIMUM LIMITS	UNITS
V _{RRM}	Repetitive peak reverse voltage, (note 1)	6200-6800	V
V _{RSM}	Non-repetitive peak reverse voltage, (note 1)	6300-6900	V

	OTHER RATINGS	MAXIMUM LIMITS	UNITS
I _{F(AV)M}	Maximum average forward current, T _{sink} =55°C, (note 2)	880	A
I _{F(AV)M}	Maximum average forward current, T _{sink} =100°C, (note 2)	595	A
I _{F(AV)M}	Maximum average forward current, T _{sink} =100°C, (note 3)	380	A
I _{F(RMS)M}	Nominal RMS forward current, T _{sink} =25°C, (note 2)	1615	A
I _{F(d.c.)}	D.C. forward current, T _{sink} =25°C, (note 4)	1480	A
I _{FSM}	Peak non-repetitive surge t _p =10ms, V _{rm} =0.6V _{RRM} , (note 5)	7000	A
I _{FSM2}	Peak non-repetitive surge t _p =10ms, V _{rm} ≤10V, (note 5)	7700	A
I ² t	I ² t capacity for fusing t _p =10ms, V _{rm} =0.6V _{RRM} , (note 5)	245×10 ³	A ² s
I ² t	I ² t capacity for fusing t _p =10ms, V _{rm} ≤10V, (note 5)	296×10 ³	A ² s
T _{j op}	Operating temperature range	-40 to +150	°C
T _{stg}	Storage temperature range	-55 to +150	°C

Notes:-

- 1) De-rating factor of 0.13% per °C is applicable for T_j below 25°C.
- 2) Double side cooled, single phase; 50Hz, 180° half-sinewave.
- 3) Single side cooled, single phase; 50Hz, 180° half-sinewave.
- 4) Double side cooled.
- 5) Half-sinewave, 150°C T_j initial.

Characteristics

	PARAMETER	MIN.	TYP.	MAX.	TEST CONDITIONS (Note 1)	UNITS
V _{FM}	Maximum peak forward voltage	-	-	3.8	I _{TM} =2625A	V
V _{T0}	Threshold voltage	-	-	0.98		V
r _T	Slope resistance	-	-	1.06		mΩ
I _{R_{RM}}	Peak reverse current	-	-	50	Rated V _{R_{RM}}	mA
I _{R_{RM}}	Peak reverse current	-	-	2	Rated V _{R_{RM}} , T _j =25°C	mA
Q _{rr}	Total recovered charge	-	5815	6450		μC
Q _{ra}	Reverse recovery charge (50% chord)	-	2211	-	I _{FM} =1000A, t _p =1ms, di/dt=10A/μs, V _r =100V	μC
I _{rm}	Reverse recovery current	-	137	-		A
t _{rr}	Reverse recovery time (50% chord)	-	33	-		μs
R _{thJK}	Thermal resistance, junction to heatsink	-	-	0.033	Double side cooled	K/W
		-	-	0.066	Single side cooled	K/W
F	Mounting force	10	-	20		kN
W _t	Weight	-	250	-		g

Notes:-

 1) Unless otherwise indicated T_j=150°C.

Notes on Ratings and Characteristics

1.0 Voltage Grade Table

Voltage Grade	V_{RRM} V	V_{RSM} V	V_R DC V
62	6200	6300	4150
65	6500	6600	4350
68	6800	6900	4550

2.0 Extension of Voltage Grades

This report is applicable to other voltage grades when supply has been agreed by Sales/Production.

3.0 De-rating Factor

A blocking voltage de-rating factor of 0.13%/°C is applicable to this device for T_j below 25°C.

4.0 Repetitive dv/dt

Standard dv/dt is 1000V/ μ s.

5.0 Snubber Components

When selecting snubber components, care must be taken not to use excessively large values of snubber capacitor or excessively small values of snubber resistor. Such excessive component values may lead to device damage due to the large resultant values of snubber discharge current. If required, please consult the factory for assistance.

6.0 Computer Modelling Parameters

6.1 Device Dissipation Calculations

$$I_{AV} = \frac{-V_{T0} + \sqrt{V_{T0}^2 + 4 \cdot ff^2 \cdot r_T \cdot W_{AV}}}{2 \cdot ff^2 \cdot r_T}$$

$$W_{AV} = \frac{\Delta T}{R_{th}}$$

and: $\Delta T = T_{jmax} - T_C$

Where $V_{T0}=0.98V$, $r_T=1.06m\Omega$,

R_{th} = Supplementary thermal impedance, see table below.

ff = Form factor, see table below.

Supplementary Thermal Impedance (at 50Hz operating frequency)				
Conduction Angle	6 phase (60°)	3 phase (120°)	Half wave (180°)	d.c.
Square wave Double Side Cooled	0.045	0.040	0.036	0.033
Square wave Single Side Cooled	0.081	0.075	0.070	0.066
Sine wave Double Side Cooled	0.042	0.038	0.034	
Sine wave Single Side Cooled	0.079	0.072	0.067	

Form Factors				
Conduction Angle	6 phase (60°)	3 phase (120°)	Half wave (180°)	d.c.
Square wave	2.45	1.73	1.41	1
Sine wave	2.78	1.88	1.57	

6.2 Calculating V_F using ABCD Coefficients

The on-state characteristic I_F vs. V_F , on page 6 is represented by a set of constants A, B, C, D, forming the coefficients of the representative equation for V_F in terms of I_F given below:

$$V_F = A + B \cdot \ln(I_F) + C \cdot I_F + D \cdot \sqrt{I_F}$$

The constants, derived by curve fitting software, are given below for both hot and cold characteristics. The resulting values for V_F agree with the true device characteristic over a current range, which is limited to that plotted.

25°C Coefficients		150°C Coefficients	
A	0.110406435	A	0.101875316
B	0.200243555	B	0.168859960
C	7.131702×10^{-4}	C	1.068433×10^{-3}
D	-1.513197×10^{-2}	D	-9.060147×10^{-3}

6.3 D.C. Thermal Impedance Calculation

$$r_t = \sum_{p=1}^{p=n} r_p \cdot \left(1 - e^{-\frac{t}{\tau_p}}\right)$$

Where $p = 1$ to n and:

- n = number of terms in the series
- t = Duration of heating pulse in seconds
- r_t = Thermal resistance at time t
- r_p = Amplitude of p^{th} term
- τ_p = Time Constant of r^{th} term

The coefficients for this device are shown in the table below:

D.C. Double Side Cooled				
Term	1	2	3	4
r_p	0.01771901	4.240625×10^{-3}	6.963806×10^{-3}	3.043661×10^{-3}
τ_p	0.7085781	0.1435833	0.03615196	2.130842×10^{-3}

D.C. Single Side Cooled					
Term	1	2	3	4	5
r_p	0.04013371	8.832199×10^{-3}	9.210899×10^{-3}	3.73647×10^{-3}	2.594797×10^{-3}
τ_p	4.073105	1.196877	0.09882439	0.01585017	2.077263×10^{-3}

7.0 Reverse recovery ratings

- (i) Q_{ra} is based on 50% I_{RM} chord as shown in Fig. 1

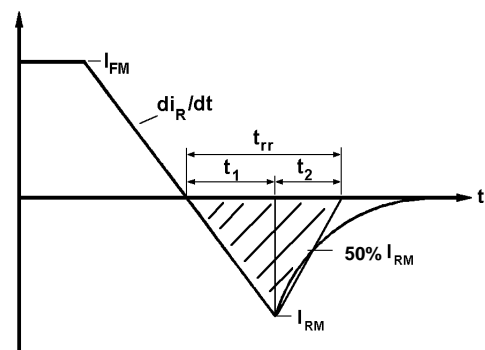

Fig. 1

- (ii) $K \text{ Factor} = \frac{t_1}{t_2}$

Curves

Figure 1 – Forward characteristics of Limit device

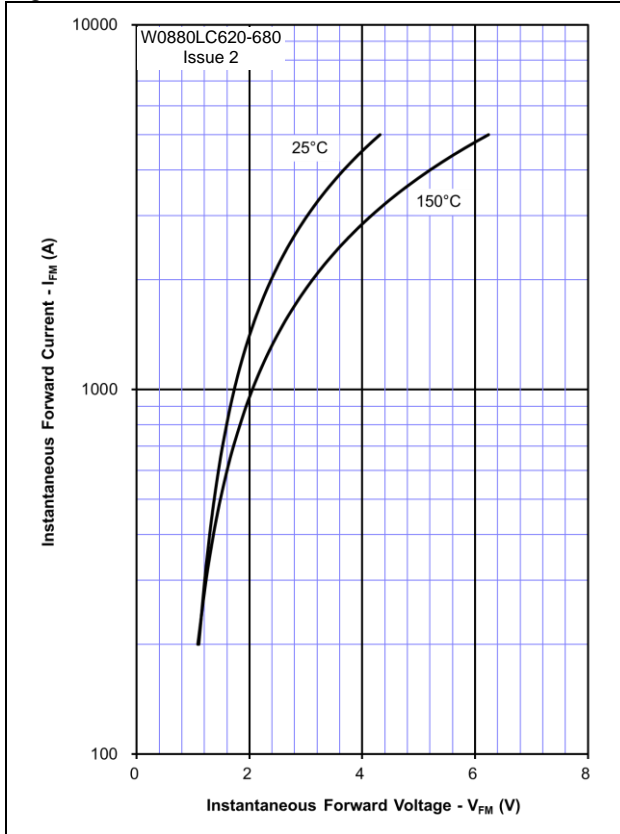

Figure 2 – Transient Thermal Impedance

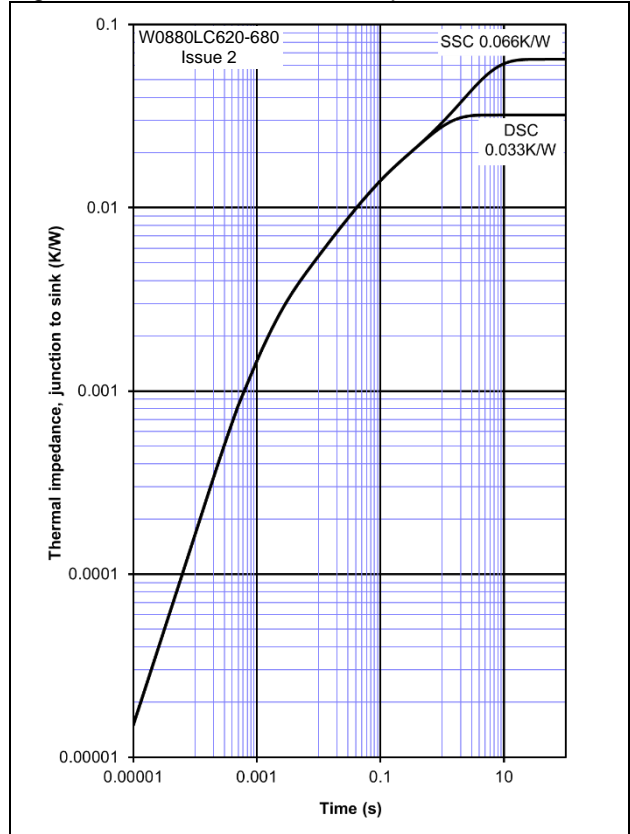

Figure 3 – Maximum surge and I²t Ratings

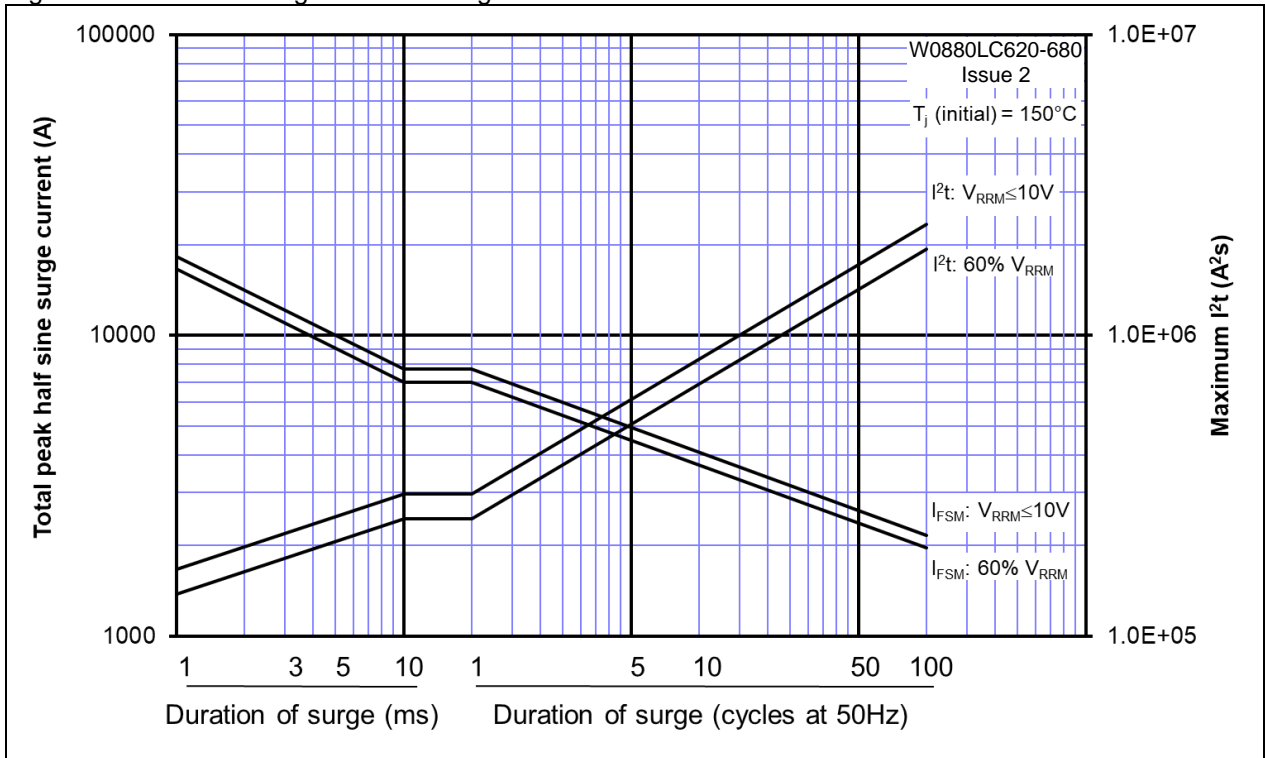

Figure 4 – Total recovered charge, Q_{rr}

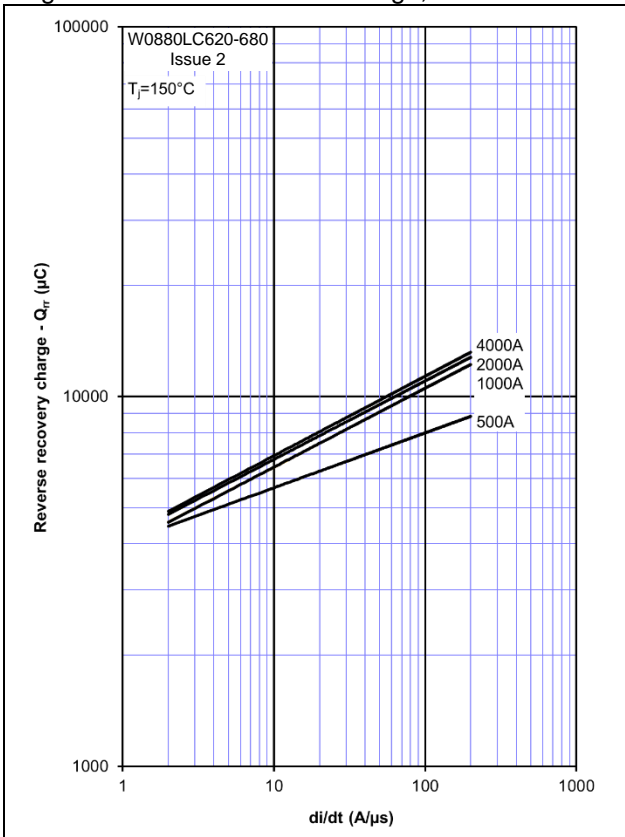

Figure 5 – Recovered charge (50% chord), Q_{ra}

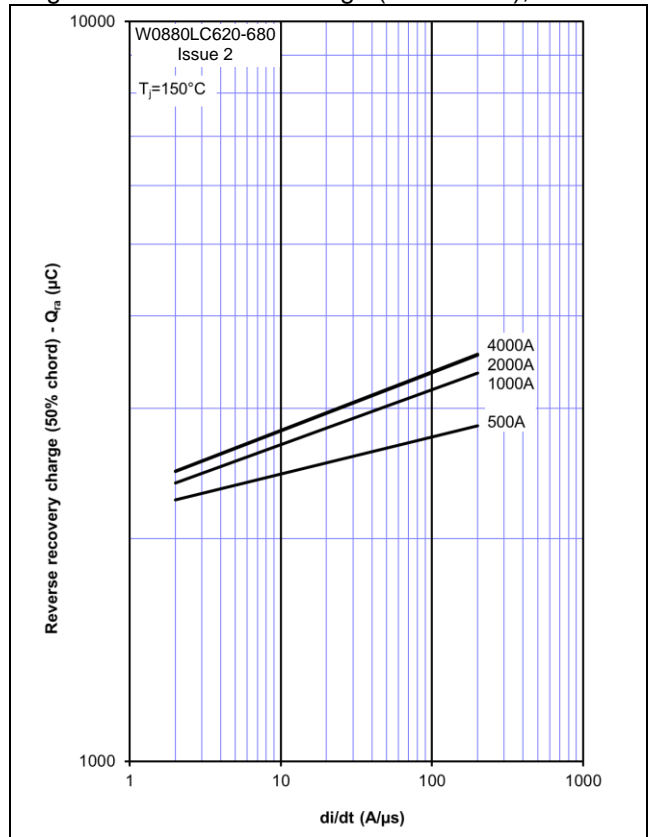

Figure 6 – Peak reverse recovery current, I_{rm}

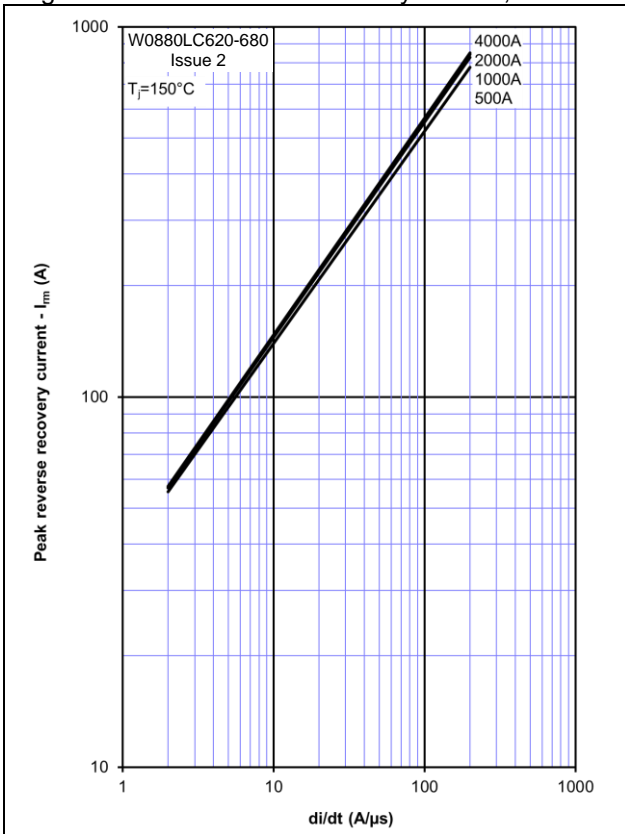

Figure 7 – Reverse recovery time (50% chord), t_{rr}

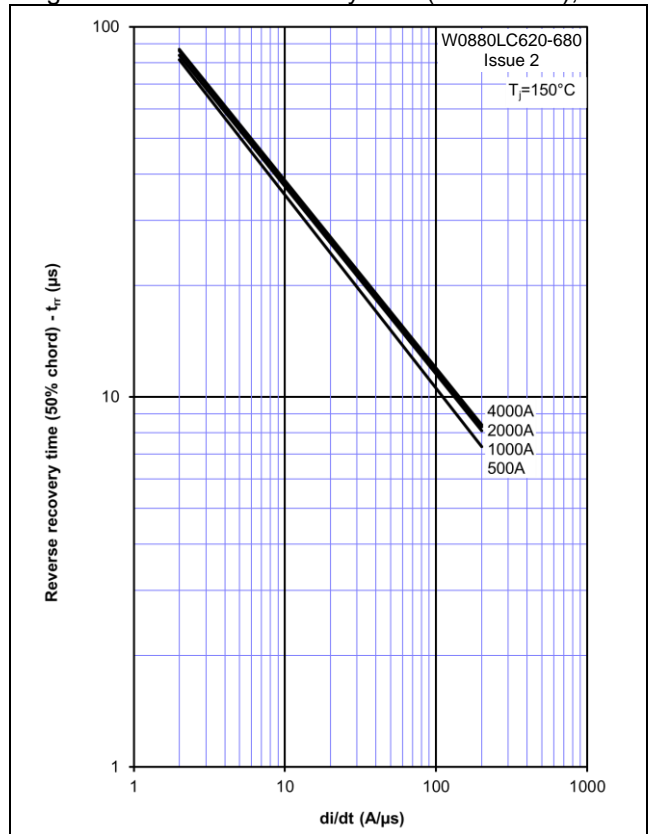

Figure 8 – Forward current vs. Power dissipation – Double Side Cooled

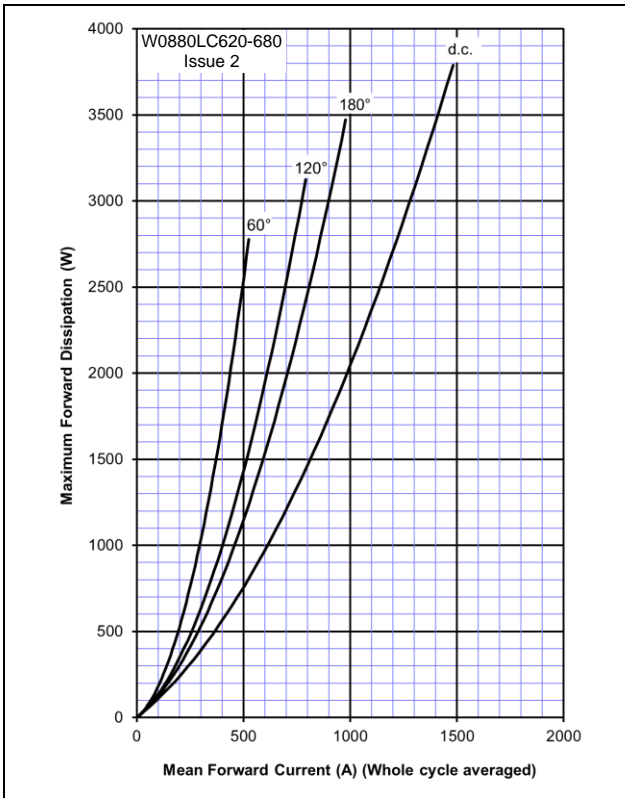

Figure 9 – Forward current vs. Heatsink temperature - Double Side Cooled

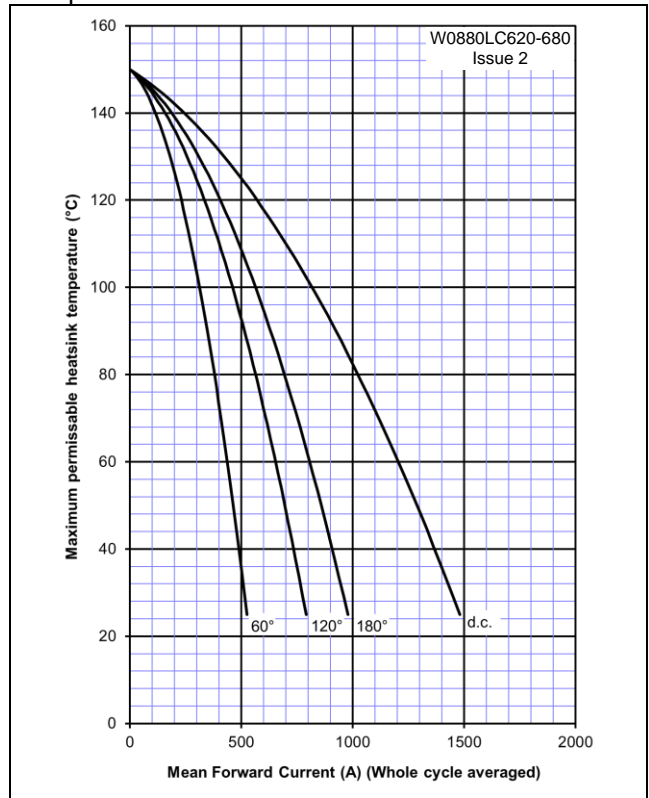

Figure 10 – Forward current vs. Power dissipation – Single Side Cooled

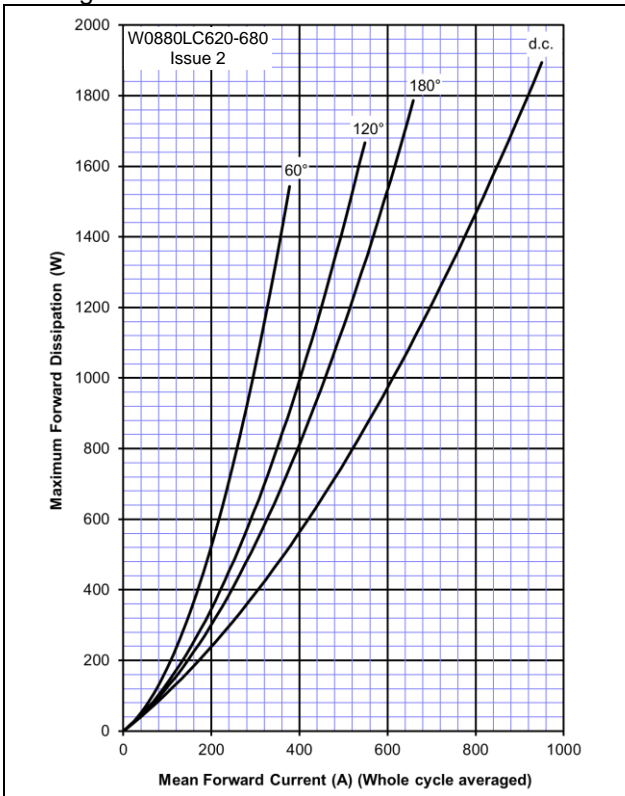
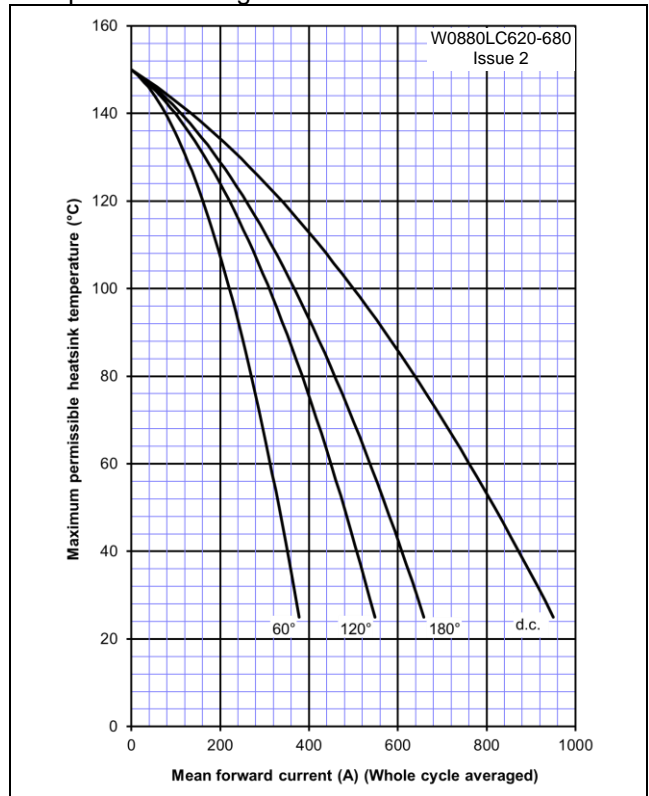
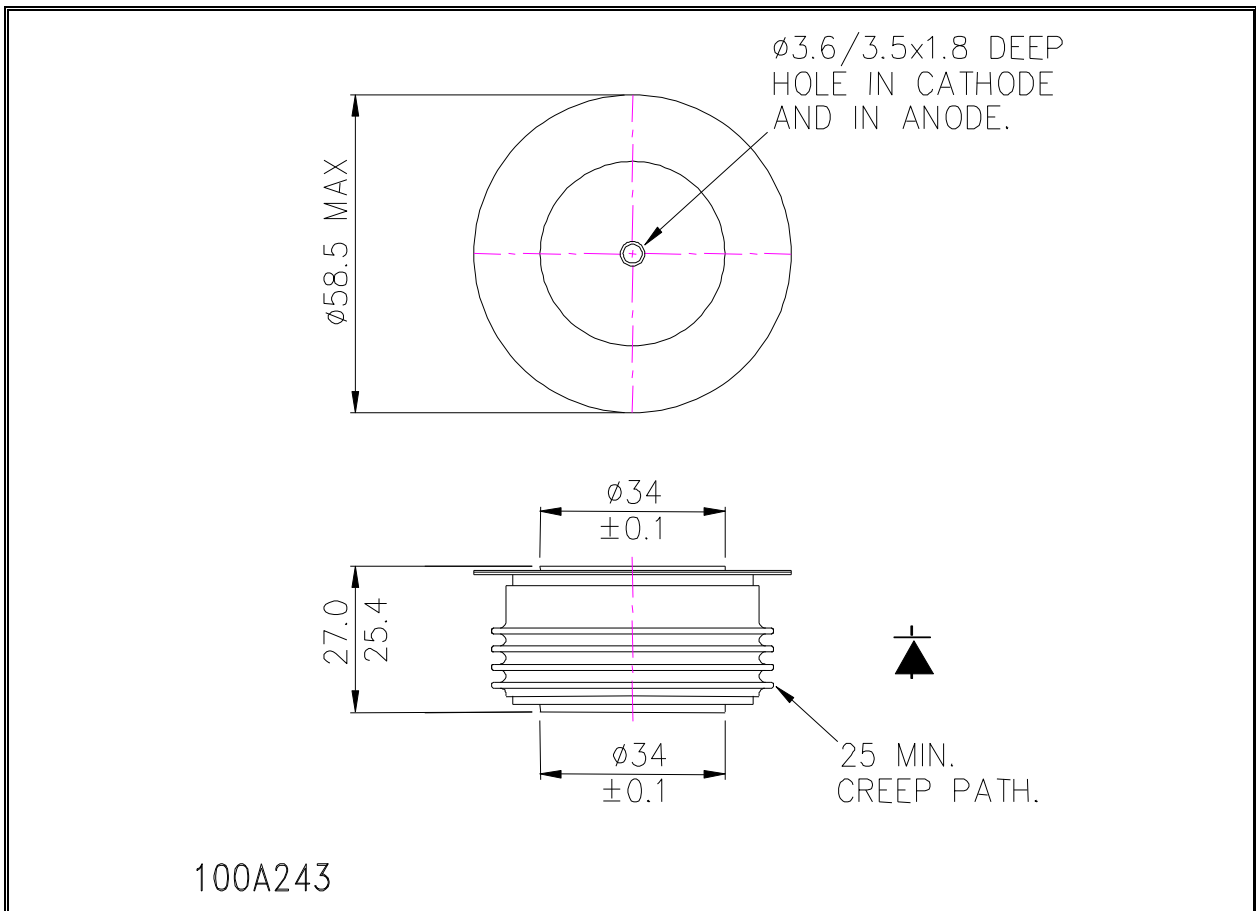

Figure 11 – Forward current vs. Heatsink temperature – Single Side Cooled



Outline Drawing & Ordering Information



100A243

ORDERING INFORMATION

(Please quote 10 digit code as below)

W0880	LC	◆◆	0
Fixed Type Code	Fixed Outline Code	Voltage code $V_{DRM}/100$ 62-68	Fixed turn-off time code

Order code: W0880LC680 – 6800V V_{RRM} , 27mm clamp height capsule

IXYS UK Westcode Ltd
Langley Park Way, Langley Park,
Chippenham, Wiltshire, SN15 1GE
Tel: +44 (0)1249 444524
Fax: +44 (0)1249 659448
E-mail:
www.littelfuse.com/contactus.aspx



IXYS Long Beach
IXYS Long Beach, Inc
2500 Mira Mar Ave, Long Beach
CA 90815
Tel: +1 (562) 296 6584
Fax: +1 (562) 296 6585
E-mail:
powerstacksus@littelfuse.com

www.littelfuse.com

<https://www.littelfuse.com/products/power-semiconductors/high-power.aspx>

The information contained herein is confidential and is protected by Copyright. The information may not be used or disclosed except with the written permission of and in the manner permitted by the proprietors IXYS UK Westcode Ltd.

© IXYS UK Westcode Ltd.

In the interest of product improvement, IXYS UK Westcode Ltd reserves the right to change specifications at any time without prior notice.

Devices with a suffix code (2-letter, 3-letter, or letter/digit/letter combination) added to their generic code are not necessarily subject to the conditions and limits contained in this report.



Disclaimer Notice - Information furnished is believed to be accurate and reliable. However, users should independently evaluate the suitability of and test each product selected for their own applications. Littelfuse products are not designed for, and may not be used in, all applications. Read complete Disclaimer Notice at www.littelfuse.com/disclaimer-electronics.