

FEATURES

- Bi-directional transient voltage protection
- Glass passivated junction
- Nano second clamping response
- Surge capability up to 250 (Amps)
- No performance degradation under service life
- Industry standard DO-214AA Jedec outline
- Available on tape (12mm)
- UL recognised

MECHANICAL CHARACTERISTICS

- Transfer molded, void free epoxy body
- Terminals: modified 'J' bend for large contact area
- Tin/Lead plated leads
- Maximum case temperature for soldering purposes: 230°C for 10 seconds
- Standard packaging: 12mm tape (meets EIA 481-1)
- Device marking, device code, logo

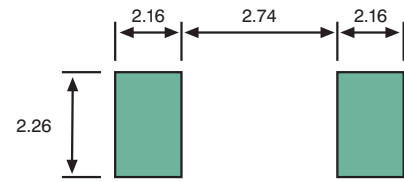

Solder Pads
All dimensions in mm

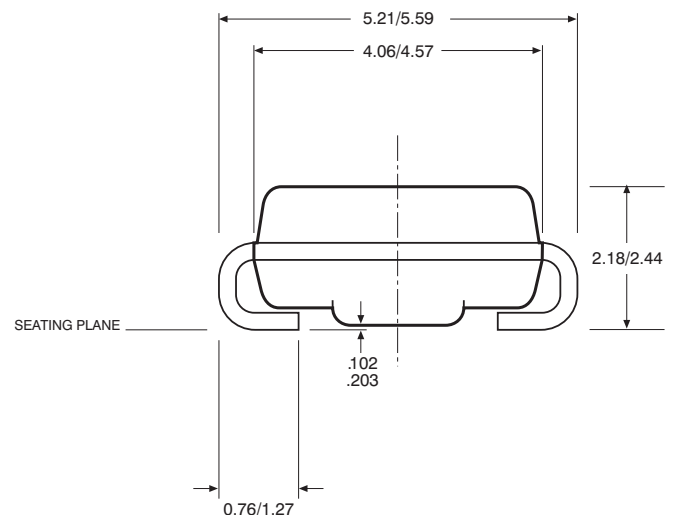
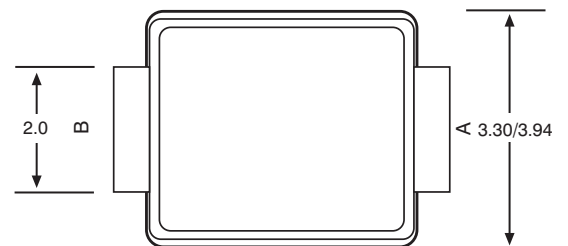
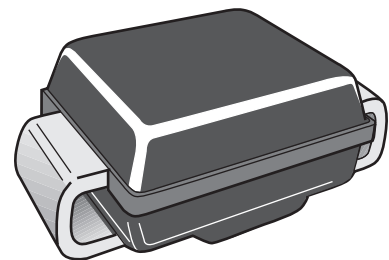

ELECTRICAL CHARACTERISTICS @ 25°C Tamb

SYMBOL	PARAMETER		
V _{RM}	Stand-off voltage	I _{RM}	Stand-off current
V _{BR}	Breakdown voltage	I _{BO}	Breakover current
V _{BO}	Breakover voltage	I _H	Holding current
V _T	On-state voltage		

ABSOLUTE RATINGS

SYMBOL	PARAMETER	VALUE			
		Type A	Type B		
I _{pp}	Peak Pulse Current	10/1000 μsec	50	100	A
		8-20 μs expo	150	250	A
I _{tsm}	Non-repetitive surge peak on-state current	tp20 ms	30		A
di/dt	Critical rate of rise of on-state current	Non-repetitive	100		A/μs
T _{stg}	Storage and operating junction temperature range		-40 to +150		°C
T _j			150		°C
TL	Maximum temperature for soldering (For period of 10 seconds max)		230		°C

Device Type	V _{rm}	I _{rm} @ V _{rm} (μA)	V _{br} MIN	V _{bo} MAX	V _t TYP @ 1A	I _{bo} TYP (mA)	I _h MIN (mA)
SMTBJ050 A or B	50	1	60	80	<2V	50	150
SMTBJ070 A or B	70	1	80	120	<2V	50	150
SMTBJ100 A or B	100	1	110	135	<2V	50	150
SMTBJ120 A or B	120	1	140	165	<2V	50	150
SMTBJ170 A or B	170	1	180	215	<2V	50	150
SMTBJ200 A or B	200	1	220	265	<2V	50	150

All parameters are tested using Fet Test™ Model 3600.